

**ANNOVACIÓN**  
RELACION ANIVERSARIO  
ESTILO  
LEALTAD  
SOLIDEZ  
PROMOCIONALES  
ARTICULOS  
EXCELENCIA  
COMERCIAL  
IMPACTO  
EVOLUCION  
DESEMPEÑO  
CREATIVIDAD  
PROMOCIONALES  
ARTICULOS  
CREATIVO  
SUSTENTABLE  
MEJORES  
MARCA  
DESEMPEÑO  
RELACION  
IDEAL

**EVOLUCIÓN**  
RELACION  
IDEA  
IMPACTO  
DESEMPEÑO  
FUEZA  
MARCAS  
ANIVERSARIO  
SUEÑOS  
SERVICIO  
DIFERENTE  
ANIVERSARIO

**ESTILO**  
ESTRATEGIA

**SERVICIO**  
PERDURABLE  
HONESTIDAD  
RESPECTO  
CANTIDAD  
CONFIANZA

**CONFIABLE**  
PROMOCIONALES  
CONFIABLE  
EVOLUCION  
NEGOCIO  
MEDIOS  
CREATIVIDAD

**ANIVERSARIO**

**CATÁLOGO 2014**



OFICINA



BOLÍGRAFOS

**03-40**

Metálicos  
Con Funciones  
Plástico

OFICINA



RELOJES

**97-102**

De Escritorio  
De Pared

BEBIDAS



TAZAS

**139-144**

De Cerámica  
Metálicas  
Con Silicón

LLAVEROS



**41-60**

Metálicos  
Plástico  
Con Funciones

CALCULADORAS



**103-106**

Colgables  
De Bolsillo  
De Escritorio

ÁNFORAS



**145-152**

De Plástico

ACCESORIOS DE CÓMPUTO



**61-72**

Set de Computo  
Mouse Pad  
Mouse  
Hub  
Fundas Laptop  
Accesorios

OFICINA



**107-115**

Set de Escritorios  
Tarjeteros  
Porta Notas  
Reconocimientos  
Portagafete

TERMOS Y CILINDROS



**153-162**

Cilindros  
Termos Plástico  
Termos Metálicos

SALUD Y BIENESTAR

ACCESORIOS SMARTPHONE Y TABLET



**73-80**

Porta Smartphone  
Touch Screen  
Porta Tablets y Fundas  
Cargadores de Batería

AGENDAS ZEGNO



**116-120**

De Bolsillo  
Diaria  
Ejecutiva

BELLEZA



**163-173**

Espejos, Limas  
Set de Brochas  
Set de Manicure y Pedicure  
Alhajeros, Costureros  
Cosmetiqueras

AUDIO Y BOCINAS



**81-88**

Bocinas  
MP3  
Audífonos

CARPETAS Y CALENDARIOS

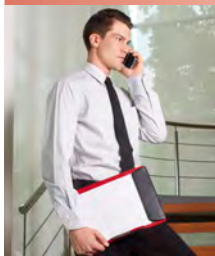

**121-128**

Carpetas  
Calendarios

SALUD



**174-186**

Higiene  
Antibacteriales  
Mentas  
Cuidado Personal  
Pastilleros  
Anti-Stress

USB



**89-96**

Colgables  
Metálicas  
Plástico

LIBRETAS



**129-138**

Con Accesorios  
Con Resorte  
Ecológicas  
Ejecutivas  
Con Espiral

HOGAR

NIÑOS



**187-198**

Juguetes  
Escolares

## HOGAR



### PORTARRETRATOS

**199-203**

Con Funciones  
De Escritorio  
Digital



### HOGAR

**204-212**

Set de Cuchillos  
Botaneros  
Cocina  
Loncheras  
Asadores  
BBQ



### VIAJE

**213-220**

Frazadas  
Accesorios  
Porta Pasaporte  
Playa  
Toallas



### PARAGUAS

**221-224**

De Bolsillo  
Cuadrado  
Con Funda



### HERRAMIENTAS

**225-240**

Lámparas  
Flexómetro  
Navajas  
Automovil  
Sets  
Martillos



### VINOS

**241-246**

Encendedor  
Accesorios  
Sets para Vinos  
Licorera

## TIEMPO LIBRE



### ENTRETENIMIENTO

**247-252**

Juegos de Mesa  
Casino

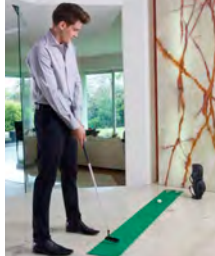

### DEPORTES

**253-256**

Balones  
Golf



## TEXTILES

### HIELERAS Y LONCHERAS

**257-260**

2 Six  
1 Six  
Loncheras



### BOLSAS

**261-272**

Ecológicas  
Metálicas  
Bolsa-Mochila  
Casual  
Playa



### MOCHILAS

**273-286**

Escolares  
Camping  
Porta Laptop  
Trolley



### PORTA LAPTOP

**287-294**

Casual  
Ejecutivas

## TEXTILES

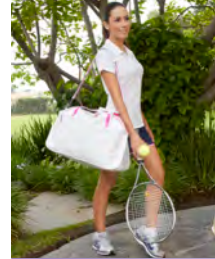

### MALETAS

**295-306**

Sport  
Viaje  
Ejecutivas  
Trolley



### PLAYERAS

**307-310**

Dama  
Caballero



### GORRAS

**311-315**

Visera  
Sport  
Sombrero



### CHAMARRAS

**316-318**

Rompevientos  
Unisex  
Camping



## IMPULSA

### IMPULSA

**319-324**

Varios

## SH 1370

BOLÍGRAFO ACRUX



S



R O A V Y B

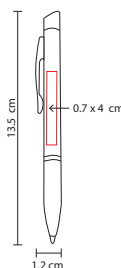

**Material:** Metal  
**Medida:** 1.2 x 13.5 cm  
**Área de Impresión:** 0.7 x 4 cm  
**Técnica de Impresión:** Láser  
**Colores:** A/B/O/R/S/V/Y  
**Tinta:** Negra

Mecanismo twist. Incluye punta para agenda electrónica y estuche.

## SH 1010

BOLÍGRAFO INC



A



N R

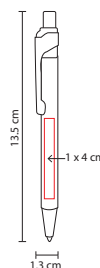

**Material:** Metal  
**Medida:** 1.3 x 13.5 cm  
**Área de Impresión:** 1 x 4 cm  
**Técnica de Impresión:** Pantógrafo  
**Colores:** A/N/R  
**Tinta:** Negra

Mecanismo pulsador.

## SH 1470

BOLÍGRAFO AZIZA



R



A N Y O B

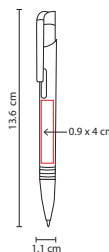

**Material:** Metal  
**Medida:** 1.1 x 13.6 cm  
**Área de Impresión:** 0.9 x 4 cm  
**Técnica de Impresión:** Pantógrafo  
**Colores:** A/B/N/O/R/Y  
**Tinta:** Negra

Mecanismo pulsador. Incluye estuche transparente.



RQ 015

BOLÍGRAFO LESTER



S



N

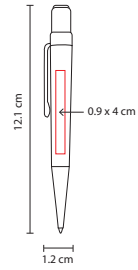

**Material:** Metal  
**Medida:** 1.2 x 12.1 cm  
**Área de Impresión:** 0.9 x 4 cm  
**Técnica de Impresión:** Grabado Espejo  
**Colores:** N/S  
**Tinta:** Negra

Mecanismo twist. Incluye estuche.

RQ 008

BOLÍGRAFO EVEREST

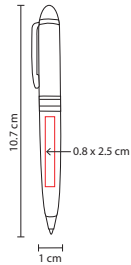

**Material:** Metal  
**Medida:** 1 x 10.7 cm  
**Área de Impresión:** 0.8 x 2.5 cm  
**Técnica de Impresión:** Grabado Espejo  
**Colores:** Negro  
**Tinta:** Negra

Mecanismo twist. Incluye estuche.

SH 1295

BOLÍGRAFO BOSTON



R



N



S



A

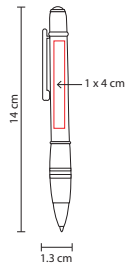

**Material:** Metal Esmaltado  
**Medida:** 1.3 x 14 cm  
**Área de Impresión:** 1 x 4 cm  
**Técnica de Impresión:** Grabado Espejo / Láser  
**Colores:** A/N/R/S  
**Tinta:** Negra

Mecanismo twist. Incluye estuche.

## SH 1280

BOLÍGRAFO ERIE

ZEGNO®  
ESCRITURA

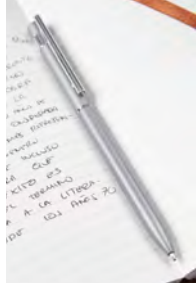
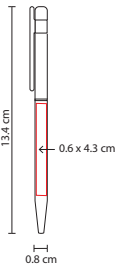

**Material:** Metal  
**Medida:** 0.8 x 13.4 cm  
**Área de Impresión:** 0.6 x 4.3 cm  
**Técnica de Impresión:** Grabado Espejo  
**Colores:** B/G/N/S  
**Tinta:** Negra

Mecanismo twist. Incluye estuche.

## SH 1245

BOLÍGRAFO RIGA

ZEGNO®  
ESCRITURA

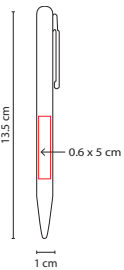

**Material:** Metal  
**Medida:** 1 x 13.5 cm  
**Área de Impresión:** 0.6 x 5 cm  
**Técnica de Impresión:** Grabado Espejo  
**Colores:** A/B/N/O/P/R/S/V Metalizados  
**Tinta:** Negra

Mecanismo twist. Incluye estuche.

## SH 3500

BOLÍGRAFO PERSIS

ZEGNO®  
ESCRITURA

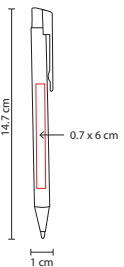

**Material:** Metal  
**Medida:** 1 x 14.7 cm  
**Área de Impresión:** 0.7 x 6 cm  
**Técnica de Impresión:** Pantógrafo  
**Colores:** A/N/S  
**Tinta:** Negra

Mecanismo pulsador. Incluye estuche.

## SH 6500

BOLÍGRAFO PLATINUM

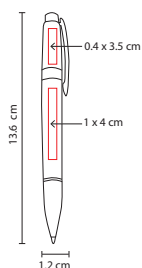

**Material:** Metal  
**Medida:** 1.2 x 13.6 cm  
**Área de Impresión:** 1 x 4 cm  
**Técnica de Impresión:** Grabado Espejo  
**Colores:** A/B/O/R/V/Y  
**Tinta:** Negra

Mecanismo twist. Incluye estuche con ventana.

## RQ 1002

BOLÍGRAFO ROLLER BALL

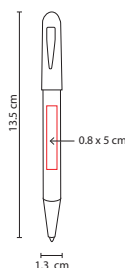

**Material:** Metal  
**Medida:** 1.3 x 13.5 cm  
**Área de Impresión:** 0.8 x 5 cm  
**Técnica de Impresión:** Grabado Espejo  
**Colores:** Negro  
**Tinta:** Negra

Bolígrafo con tapón. Incluye estuche.

## RQ 1003

BOLÍGRAFO ROLLER BALL

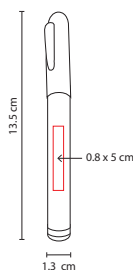

**Material:** Metal  
**Medida:** 1.3 x 13.5 cm  
**Área de Impresión:** 0.8 x 5 cm  
**Técnica de Impresión:** Grabado Espejo  
**Colores:** Azul  
**Tinta:** Negra

Bolígrafo con tapón. Incluye estuche.



## SH 1260

BOLÍGRAFO MAO

Z E G N O<sup>®</sup>  
E S C R I T U R A

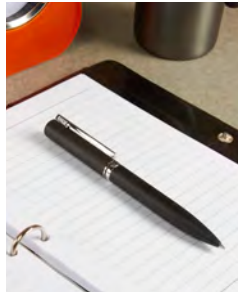
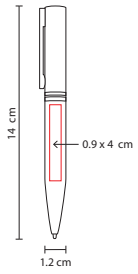

C



R



A



N

**Material:** Metal  
**Medida:** 1,2 x 14 cm  
**Área de Impresión:** 0,9 x 4 cm  
**Técnica de Impresión:** Grabado Espejo  
**Colores:** A/C/N/R  
**Tinta:** Negra

Mecanismo twist. Terminado rubber. Incluye estuche.

## SH 1275

BOLÍGRAFO DURBAN

Z E G N O<sup>®</sup>  
E S C R I T U R A

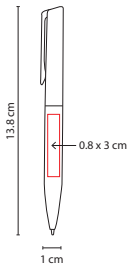

G



N



B

**Material:** Metal  
**Medida:** 1 x 13,8 cm  
**Área de Impresión:** 0,8 x 3 cm  
**Técnica de Impresión:** Grabado Espejo  
**Colores:** B/G/N  
**Tinta:** Negra

Mecanismo twist. Incluye estuche.

## SH 1210

BOLÍGRAFO GALI

Z E G N O<sup>®</sup>  
E S C R I T U R A

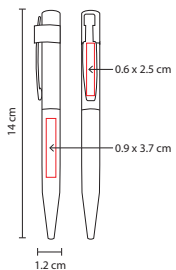

A



O



M



Y



S



V



R

**Material:** Metal  
**Medida:** 1,2 x 14 cm  
**Área de Impresión:** 0,9 x 3,7 cm Barril /  
0,6 x 2,5 cm Clip  
**Técnica de Impresión:** Grabado Espejo  
**Colores:** A/M/O/R/S/V/Y  
**Tinta:** Negra

Mecanismo twist. Incluye estuche.



## SH 1355

BOLÍGRAFO BURDEOS



R



A



N

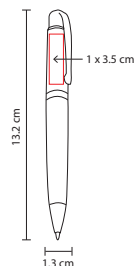

**Material:** Metal  
**Medida:** 1.3 x 13.2 cm  
**Área de Impresión:** 1 x 3.5 cm  
**Técnica de Impresión:** Pantógrafo  
**Colores:** A/N/R  
**Tinta:** Negra

Mecanismo twist. Incluye estuche imantado.

## SH 5500

BOLÍGRAFO BEKER



N



S



R

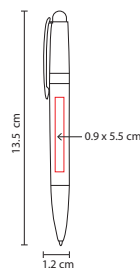

**Material:** Metal  
**Medida:** 1.2 x 13.5 cm  
**Área de Impresión:** 0.9 x 5.5 cm  
**Técnica de Impresión:** Grabado Espejo  
**Colores:** N/R/S  
**Tinta:** Negra

Mecanismo twist. Incluye estuche.

## KIT RQ 200

BOLÍGRAFO NEVSKY



A



Y



S



N



R



B



P

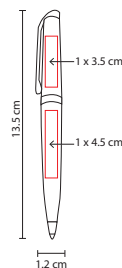

**Material:** Metal  
**Medida:** 1.2 x 13.5 cm  
**Área de Impresión:** 1 x 4.5 cm  
**Técnica de Impresión:** Grabado Espejo  
**Colores:** A/B/N/P/R/S/Y  
**Tinta:** Negra

Mecanismo twist. Incluye estuche cilíndrico translúcido.

## SH 1225

BOLÍGRAFO ELAN

Z E G N O<sup>®</sup>  
ESCRITURA

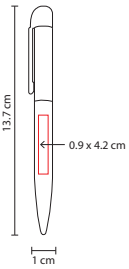

**Material:** Metal  
**Medida:** 1 x 13.7 cm  
**Área de Impresión:** 0.9 x 4.2 cm  
**Técnica de Impresión:** Grabado Espejo  
**Colores:** A/M/N/O/R/V/  
**Tinta:** Negra

Mecanismo twist. Incluye estuche.

## SH 1255

BOLÍGRAFO USB  
LORIEN

Z E G N O<sup>®</sup>  
ESCRITURA

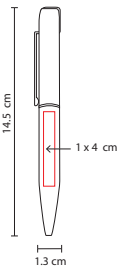

**Material:** Metal  
**Medida:** 1.3 x 14.5 cm  
**Área de Impresión:** 1 x 4 cm  
**Técnica de Impresión:** Grabado Espejo  
**Colores:** Negro  
**Tinta:** Negra  
**Capacidad:** 4 GB

Bolígrafo USB de 4GB. Terminado rubber. Mecanismo twist. Incluye estuche.

## USB 05

BOLÍGRAFO USB  
STERRA

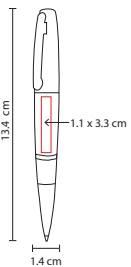

**Material:** Metal  
**Medida:** 1.4 x 13.4 cm  
**Área de Impresión:** 1.1 x 3.3 cm  
**Técnica de Impresión:** Grabado Espejo  
**Colores:** Gris Oxford  
**Tinta:** Negra  
**Capacidad:** 2 GB

Bolígrafo USB de 2GB. Mecanismo twist. Incluye estuche y repuesto metálico.



## BX 205

ESTUCHE CILÍNDRICO



**Material:** Plástico  
**Medida:** 2 x 14.9 cm  
**Área de Impresión:** 2 x 11 cm  
**Técnica de Impresión:** Serigrafía  
**Colores:** Transparente

No incluye bolígrafo.

## BX 155

ESTUCHE KAZ

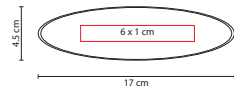

**Material:** Plástico  
**Medida:** 17 x 4.5  
**Área de Impresión:** 6 x 1 cm  
**Técnica de Impresión:** Serigrafía  
**Colores:** Transparente con Gris

No incluye bolígrafo.

## EST 030

SET DURHAM



Bolígrafo Tinta Azul



Lapicera



Bolígrafo Tinta Roja

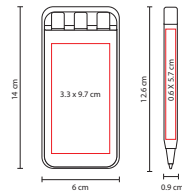

**Material:** Plástico  
**Medida:** 0.9 x 12.6 cm Bolígrafo / 6 x 14 cm Estuche  
**Área de Impresión:** 0.6 x 5.7 cm Bolígrafo / 3.3 x 9.7 cm Estuche  
**Técnica de Impresión:** Serigrafía  
**Colores:** Blanco con Gris  
**Tinta:** Azul / Roja

Incluye lapicera 0.5 mm, bolígrafos tinta azul y roja.

## SH 1720

PORTA PLUMA MELIA



R



B

A

S

V

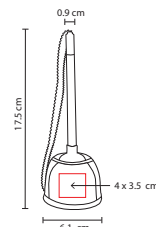

**Material:** Plástico  
**Medida:** 6.1 x 17.5 cm  
**Área de Impresión:** 4 x 3.5 cm  
**Técnica de Impresión:** Serigrafía  
**Colores:** A/B/R/S/V  
**Tinta:** Negra

Mecanismo base-tapón. Incluye adhesivo en la parte inferior.

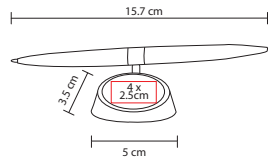

**Material:** Metal  
**Medida:** 5 x 3.5 cm Base / 15.7 cm Bolígrafo  
**Área de Impresión:** 4 x 2.5 cm Base  
**Técnica de Impresión:** Pantógrafo / Serigrafía  
**Colores:** Plata  
**Tinta:** Negra

Bolígrafo giratorio con base.



SH 1290

BOLÍGRAFO IMANT

EST 015

SET COBALT

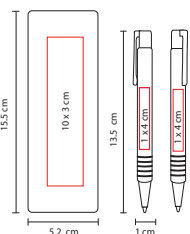

**Material:** Metal  
**Medida:** 1 x 13.5 cm Bolígrafo / 15.5 x 5.2 cm Estuche  
**Área de Impresión:** 1 x 4 cm Bolígrafo / 10 x 3 cm Estuche  
**Técnica de Impresión:** Serigrafía  
**Colores:** A/B/R  
**Tinta:** Negra

Mecanismo pulsador. Incluye bolígrafo, lapicera 0.5 mm y estuche metálico.



Bolígrafo

Lapicera

EST 040

SET CADMIO

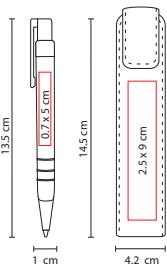

**Material:** Aluminio / Curpiel  
**Medida:** 1 x 13.5 cm Bolígrafo / 4.2 x 14.5 cm Estuche  
**Área de Impresión:** 0.7 x 5 cm Bolígrafo / 2.5 x 9 cm Estuche  
**Técnica de Impresión:** Pantógrafo / Termograbado  
**Colores:** Negro  
**Tinta:** Negra

Mecanismo pulsador. Incluye bolígrafo, lapicera 0.5 mm y estuche con imán para cerrado.



Bolígrafo

Lapicera



## SH 1100

BOLÍGRAFO MASARYK



A



R



N



**Material:** Plástico  
**Medida:** 1.1 x 14 cm  
**Área de Impresión:** 1 x 4 cm  
**Técnica de Impresión:** Serigrafía  
**Colores:** A/N/R  
**Tinta:** Negra

Bolígrafo con lámpara. Mecanismo twist. Incluye batería.

## PL 123

BOLÍGRAFO LÁSER  
LÁMPARA

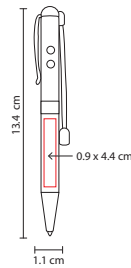

**Material:** Metal  
**Medida:** 1.1 x 13.4 cm  
**Área de Impresión:** 0.9 x 4.4 cm  
**Técnica de Impresión:** Pantógrafo / Serigrafía  
**Colores:** Plata  
**Tinta:** Negra

Mecanismo twist. Incluye estuche metálico y baterías de repuesto.

## PL 350

BOLÍGRAFO 3 EN 1  
EMPIRE



R



N



A



Apuntador Lámpara

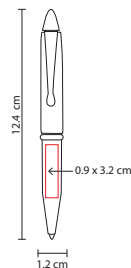

**Material:** Metal  
**Medida:** 1.2 x 12.4 cm  
**Área de Impresión:** 0.9 x 3.2 cm  
**Técnica de Impresión:** Grabado Espejo  
**Colores:** A/N/R  
**Tinta:** Negra

Bolígrafo con lámpara y apuntador para agenda electrónica. Mecanismo twist. Incluye estuche y baterías.

SH 1120  
BOLÍGRAFO LINTZ

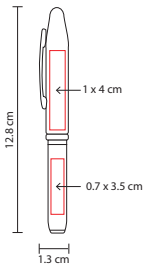

**Material:** Plástico  
**Medida:** 1,3 x 12,8 cm  
**Área de Impresión:** 0,7 x 3,5 cm  
**Técnica de Impresión:** Serigrafía  
**Colores:** A/R/S  
**Tinta:** Negra



Bolígrafo con lámpara de 1 LED y tapón. Incluye batería.

SH 1015  
BOLÍGRAFO GLIT

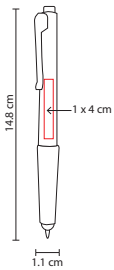

**Material:** Plástico  
**Medida:** 1,1 x 14,8 cm  
**Área de Impresión:** 1 x 4 cm  
**Técnica de Impresión:** Serigrafía  
**Colores:** A/G/R/S  
**Tinta:** Negra



Mecanismo pulsador. Incluye touch screen para smartphone y tablets.

SH 1110  
BOLÍGRAFO 2 EN 1  
DUVRA

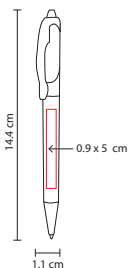

**Material:** Plástico  
**Medida:** 1,1 x 14,4 cm  
**Área de Impresión:** 0,9 x 5 cm  
**Técnica de Impresión:** Serigrafía  
**Colores:** A/G/R/S  
**Tinta:** Negra / Roja



Bolígrafo con 2 colores de tinta: Principal en color negro y roja en parte posterior. Mecanismo pulsador.



## SH 3250

MARCATEXTO LULIO



R



A

N

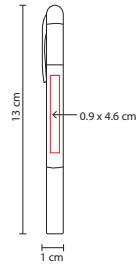

**Material:** Plástico / Cera  
**Medida:** 1 x 13 cm  
**Área de Impresión:** 0.9 x 4.6 cm  
**Técnica de Impresión:** Serigrafía  
**Colores:** A/N/R  
**Tinta:** Marcatextos Amarillo

Mecanismo twist. Marcatexto de cera.

## SH 8000

BOLÍGRAFO CAR

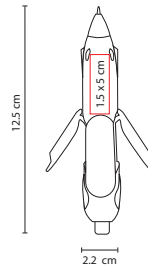

**Material:** Plástico  
**Medida:** 2.2 x 12.5 cm  
**Área de Impresión:** 1.5 x 5 cm  
**Técnica de Impresión:** Serigrafía  
**Colores:** Plata  
**Tinta:** Negra

Mecanismo pulsador.

## SH 8010

BOLÍGRAFO COHETE

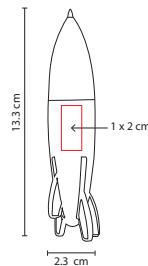

**Material:** Plástico  
**Medida:** 2.3 x 13.3 cm  
**Área de Impresión:** 1 x 2 cm  
**Técnica de Impresión:** Tampografía  
**Colores:** Plata  
**Tinta:** Azul / Negra / Roja / Verde

Mecanismo pulsador. Incluye 4 colores de tinta.



## SH 1040

SET SIXER



## SH 1215

BOLÍGRAFO 3 EN 1  
SMOKE



## SH 2700

BOLÍGRAFO CON  
PELOTA BYRON

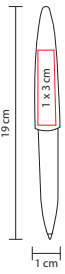

**Material:** Plástico  
**Medida:** 1 x 19 cm  
**Área de Impresión:** 1 x 3 cm  
**Técnica de Impresión:** Serigrafía  
**Colores:** Blanco  
**Tinta:** Amarilla / Azul / Morada / Negra / Roja / Verde

Incluye 6 bolígrafos con tinta de diferente color.

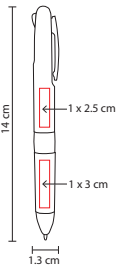

**Material:** Plástico  
**Medida:** 1,3 x 14 cm  
**Área de Impresión:** 1 x 3 cm  
**Técnica de Impresión:** Serigrafía  
**Colores:** Negro  
**Tinta:** Azul / Negra / Roja

Mecanismo pulsador por tinta.

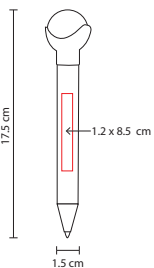

**Material:** Plástico  
**Medida:** 1,5 x 17,5 cm  
**Área de Impresión:** 1,2 x 8,5 cm  
**Técnica de Impresión:** Serigrafía  
**Colores:** A/B/R  
**Tinta:** Negra

Incluye pelota transparente. Mecanismo twist.

## SH 1145

BOLÍGRAFO ATOMIZADOR  
ANTIBACTERIAL



R



A

B

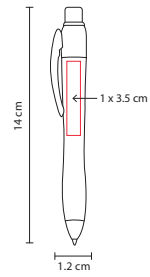

**Material:** Plástico  
**Medida:** 1.2 x 14 cm  
**Área de Impresión:** 1 x 3.5 cm  
**Técnica de Impresión:** Serigrafía  
**Colores:** A/B/R  
**Tinta:** Negra

Compartimento para gel antibacterial recargable. Incluye atomizador. Mecanismo twist.

## SH 1600

BOLÍGRAFO COEL



V



N

R

O

A

B

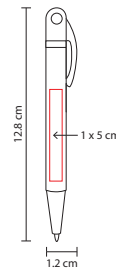

**Material:** Plástico  
**Medida:** 1.2 x 12.8 cm  
**Área de Impresión:** 1 x 5 cm  
**Técnica de Impresión:** Serigrafía  
**Colores:** A/B/N/O/R/V  
**Tinta:** Negra

Mecanismo twist. Incluye cordón.

## SH 1200

BOLÍGRAFO  
DESTAPADOR



O



R

B

A

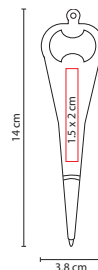

**Material:** Plástico  
**Medida:** 3.8 x 14 cm  
**Área de Impresión:** 1.5 x 2 cm  
**Técnica de Impresión:** Serigrafía  
**Colores:** A/B/O/R  
**Tinta:** Negra

Mecanismo twist. Incluye cordón.

K 511

BOLÍGRAFO LLAVERO

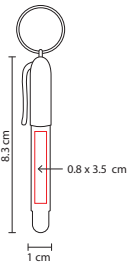

**Material:** Plástico  
**Medida:** 1 x 8,3 cm  
**Área de Impresión:** 0,8 x 3,5 cm  
**Técnica de Impresión:** Serigrafía  
**Colores:** A/R/V/Y  
**Tinta:** Negra

Bolígrafo con llavero en el tapón.



SH 1350

BOLÍGRAFO AMUR

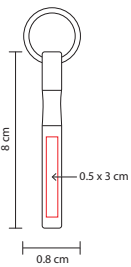

**Material:** Plástico  
**Medida:** 0,8 x 8 cm  
**Área de Impresión:** 0,5 x 3 cm  
**Técnica de Impresión:** Serigrafía  
**Colores:** A/O/R/V/Y  
**Tinta:** Negra

Bolígrafo con llavero en el tapón.

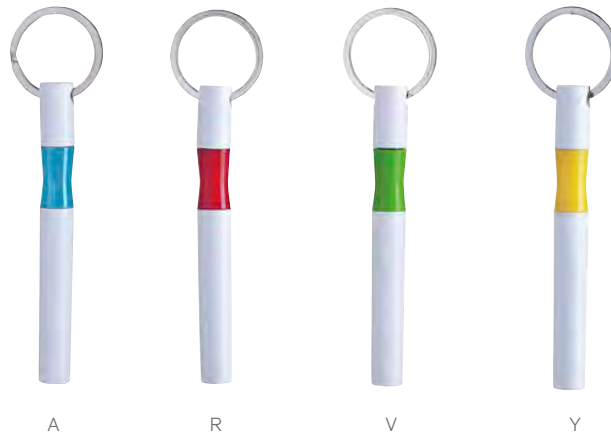

SH 1500

BOLÍGRAFO HANDY

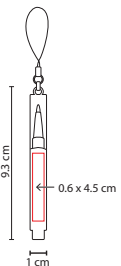

**Material:** Plástico  
**Medida:** 1 x 9,3 cm  
**Área de Impresión:** 0,6 x 4,5 cm  
**Técnica de Impresión:** Serigrafía  
**Colores:** A/B/O/R/V  
**Tinta:** Negra

Bolígrafo con tapón. Incluye colgante para celular.



## SH 1405

BOLÍGRAFO KIVU



AT



RT

B

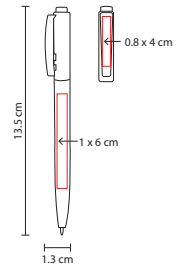

**Material:** Plástico  
**Medida:** 1.3 x 13.5 cm  
**Área de Impresión:** 1 x 6 cm Barril /  
0.8 x 4 cm Clip  
**Técnica de Impresión:** Serigrafía  
**Colores:** AT/B/RT  
**Tinta:** Negra

Mecanismo pulsador.

## SH 1123

BOLÍGRAFO VIKINGO



Y



O

R

A

N

V

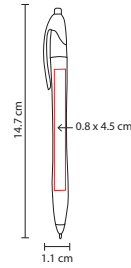

**Material:** Plástico  
**Medida:** 1.1 x 14.7 cm  
**Área de Impresión:** 0.8 x 4.5 cm  
**Técnica de Impresión:** Serigrafía  
**Colores:** A/N/O/R/V/Y  
**Tinta:** Negra

Mecanismo pulsador.

## SH 1090

BOLÍGRAFO HOBART



N



A

R

V

O

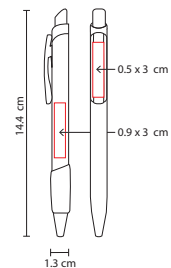

**Material:** Plástico  
**Medida:** 1.3 x 14.4 cm  
**Área de Impresión:** 0.9 x 3 cm Barril /  
0.5 x 3 cm Clip  
**Técnica de Impresión:** Serigrafía  
**Colores:** A/N/O/R/V  
**Tinta:** Negra

Mecanismo pulsador.

SH 1460

BOLÍGRAFO VENTURE

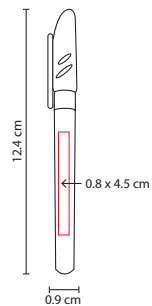

**Material:** Plástico  
**Medida:** 0.9 x 12.4 cm  
**Área de Impresión:** 0.8 x 4.5 cm  
**Técnica de Impresión:** Serigrafía  
**Colores:** A/M/N/O/P/R/V/Y  
**Tinta:** Negra

Bolígrafo con tapón.

SH 1465

BOLÍGRAFO DARK

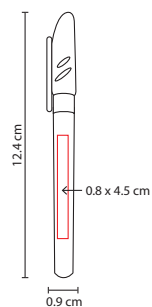

**Material:** Plástico  
**Medida:** 0.9 x 12.4 cm  
**Área de Impresión:** 0.8 x 4.5 cm  
**Técnica de Impresión:** Serigrafía  
**Colores:** A/O/R/V/Y  
**Tinta:** Negra

Bolígrafo con tapón.

## SH 1135

BOLÍGRAFO SLIM



R



V Y A O N

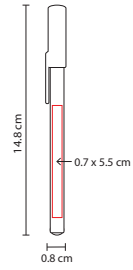

**Material:** Plástico  
**Medida:** 0.8 x 14.8 cm  
**Área de Impresión:** 0.7 x 5.5 cm  
**Técnica de Impresión:** Serigrafía  
**Colores:** A/N/O/R/V/Y  
**Tinta:** Negra

Bolígrafo con tapón.

## SH 1415

BOLÍGRAFO ARROW



P



V N R O Y B A

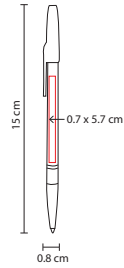

**Material:** Plástico  
**Medida:** 0.8 x 15 cm  
**Área de Impresión:** 0.7 x 5.7 cm  
**Técnica de Impresión:** Serigrafía  
**Colores:** A/B/N/O/P/R/V/Y  
**Tinta:** Negra

Bolígrafo con tapón.

## SH 1030

BOLÍGRAFO ÁMBAR



N



R V O A

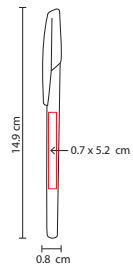

**Material:** Plástico  
**Medida:** 0.8 x 14.9 cm  
**Área de Impresión:** 0.7 x 5.2 cm  
**Técnica de Impresión:** Serigrafía  
**Colores:** A/N/O/R/V  
**Tinta:** Negra

Bolígrafo con tapón.

SH 1380

BOLÍGRAFO DONATO

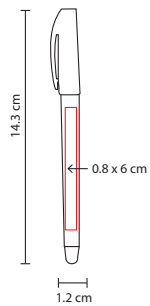

V

**Material:** Plástico  
**Medida:** 1.2 x 14.3 cm  
**Área de Impresión:** 0.8 x 6 cm  
**Técnica de Impresión:** Serigrafía  
**Colores:** A/M/N/O/R/V  
**Tinta:** Negra

Bolígrafo con tapón.

SH 1065

BOLÍGRAFO NAVIA

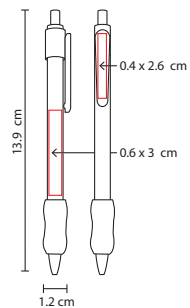

O

**Material:** Plástico  
**Medida:** 1.2 x 13.9 cm  
**Área de Impresión:** 0.6 x 3 cm Barril /  
0.4 x 2.6 cm Clip  
**Técnica de Impresión:** Serigrafía  
**Colores:** A/M/N/O/R/V  
**Tinta:** Negra

Mecanismo pulsador.

## SH 2097

### BOLÍGRAFO FUROR



VT



WT

AT

RT

YT

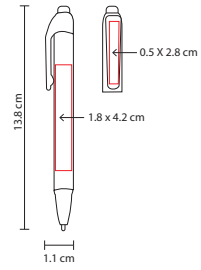

**Material:** Plástico  
**Medida:** 1.1 x 13.8 cm  
**Área de Impresión:** 1.8 x 4.2 cm Barril /  
0.5 x 2.8 cm Clip  
**Técnica de Impresión:** Serigrafía  
**Colores:** AT/RT/VT/WT/YT  
**Tinta:** Negra

Mecanismo pulsador.

## SH 1630

### BOLÍGRAFO MAGDE



N



V

R

O

A

Y

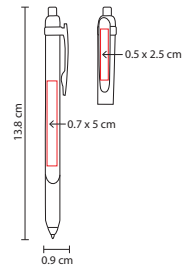

**Material:** Plástico  
**Medida:** 0.9 x 13.8 cm  
**Área de Impresión:** 0.7 x 5 cm Barril /  
0.5 x 2.5 cm Clip  
**Técnica de Impresión:** Serigrafía  
**Colores:** A/N/O/R/V/Y  
**Tinta:** Negra

Mecanismo pulsador.

## SH 1620

### BOLÍGRAFO CYGNUS



R



B

A

O

N

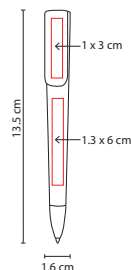

**Material:** Plástico  
**Medida:** 1.6 x 13.5 cm  
**Área de Impresión:** 1.3 x 6 cm Barril /  
1 x 3 cm Clip  
**Técnica de Impresión:** Serigrafía  
**Colores:** A/B/N/O/R  
**Tinta:** Negra

Mecanismo twist. Barril plano.



## SH 1390

### BOLÍGRAFO ESPIEL

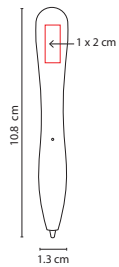

**Material:** Plástico  
**Medida:** 1,3 x 10,8 cm  
**Área de Impresión:** 1 x 2 cm  
**Técnica de Impresión:** Serigrafía  
**Colores:** A/B/O/P/R/V  
**Tinta:** Negra



Incluye pieza con adhesivo para sujetar el bolígrafo. Barril plano.

## SH 1385

### BOLÍGRAFO BEIRA

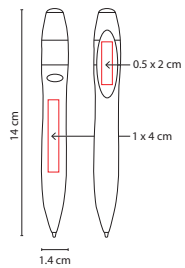

**Material:** Plástico  
**Medida:** 1,4 x 14 cm  
**Área de Impresión:** 1 x 4 cm Barril /  
0,5 x 2 cm Clip  
**Técnica de Impresión:** Serigrafía  
**Colores:** A/N/O/R/V  
**Tinta:** Negra



Mecanismo pulsador. Barril plano.

## SH 1300

### BOLÍGRAFO LENNA

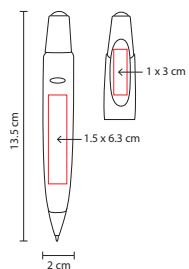

**Material:** Plástico  
**Medida:** 2 x 13,5 cm  
**Área de Impresión:** 1,5 x 6,3 cm Barril /  
1 x 3 cm Clip  
**Técnica de Impresión:** Serigrafía  
**Colores:** A/N/O/R/V/Y  
**Tinta:** Negra



Mecanismo pulsador. Barril plano.

## SH 7850

### BOLÍGRAFO INSIGNIA



V



A

R

S

Y

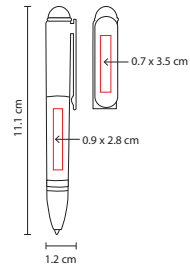

**Material:** Plástico  
**Medida:** 1.2 x 11.1 cm  
**Área de Impresión:** 0.9 x 2.8 cm Barril / 0.7 x 3.5 cm Clip  
**Técnica de Impresión:** Serigrafía  
**Colores:** A/R/S/V/Y Metalizados  
**Tinta:** Negra

Mecanismo pulsador.

## SH 1310

### BOLÍGRAFO COOPER



N



R

Y

V

O

A

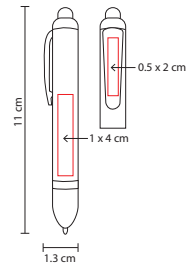

**Material:** Plástico  
**Medida:** 1.3 x 11 cm  
**Área de Impresión:** 1 x 4 cm Barril / 0.5 x 2 cm Clip  
**Técnica de Impresión:** Serigrafía  
**Colores:** A/N/O/R/V/Y  
**Tinta:** Negra

Mecanismo pulsador.

## SH 1450

### BOLÍGRAFO CHAD



A



N

V

R

O

Y

M

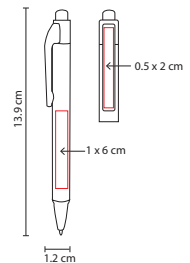

**Material:** Plástico  
**Medida:** 1.2 x 13.9 cm  
**Área de Impresión:** 1 x 6 cm Barril / 0.5 x 2 cm Clip  
**Técnica de Impresión:** Serigrafía  
**Colores:** A/M/N/O/R/V/Y  
**Tinta:** Azul

Mecanismo pulsador.

## SH 1060

BOLÍGRAFO TAMY

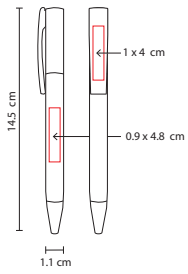

**Material:** Plástico  
**Medida:** 1.1 x 14.5 cm  
**Área de Impresión:** 0.9 x 4.8 cm Barril / 1 x 4 cm Clip  
**Técnica de Impresión:** Serigrafía  
**Colores:** A/N/O/R/V  
**Tinta:** Negra

Mecanismo twist.

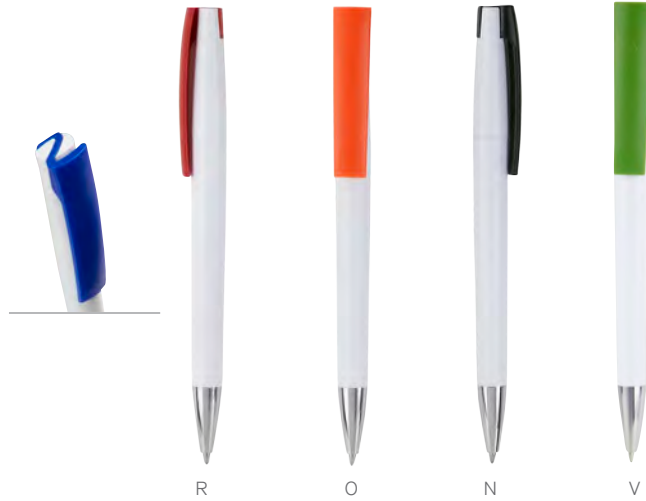

## SH 1020

BOLÍGRAFO KRIVA

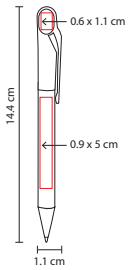

**Material:** Plástico  
**Medida:** 1.1 x 14.4 cm  
**Área de Impresión:** 0.9 x 5 cm Barril / 0.6 x 1.1 cm Óvalo en Clip  
**Técnica de Impresión:** Serigrafía  
**Colores:** A/N/O/R/V  
**Tinta:** Negra

Mecanismo twist.



## SH 1095

BOLÍGRAFO EKHOR

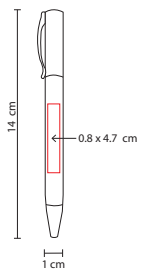

**Material:** Plástico  
**Medida:** 1 x 14 cm  
**Área de Impresión:** 0.8 x 4.7 cm  
**Técnica de Impresión:** Serigrafía  
**Colores:** A/N/O/R/V/Y  
**Tinta:** Negra

Mecanismo twist.



## SH 1005

### BOLÍGRAFO SCRIPT



A



R

N

V

O

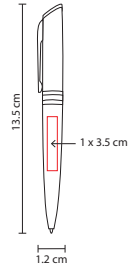

**Material:** Plástico  
**Medida:** 1.2 x 13.5 cm  
**Área de Impresión:** 1 x 3.5 cm  
**Técnica de Impresión:** Serigrafía  
**Colores:** A/N/O/R/V  
**Tinta:** Negra

Mecanismo twist.

## SH 1570

### BOLÍGRAFO RING



Y



R

A

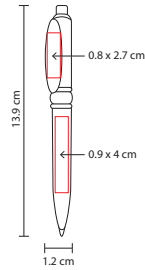

**Material:** Plástico  
**Medida:** 1.2 x 13.9 cm  
**Área de Impresión:** 0.9 x 4 cm Barril /  
 0.8 x 2.7 cm Clip  
**Técnica de Impresión:** Serigrafía  
**Colores:** A/R/Y  
**Tinta:** Negra

Mecanismo pulsador.

## SH 1605

### BOLÍGRAFO LOTO



OT



NT

BT

AT

MT

VT

RT

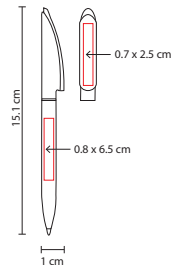

**Material:** Plástico  
**Medida:** 1 x 15.1 cm  
**Área de Impresión:** 0.8 x 6.5 cm Barril /  
 0.7 x 2.5 cm Clip  
**Técnica de Impresión:** Serigrafía  
**Colores:** AT/BT/MT/NT/OT/RT/VT  
**Tinta:** Negra

Mecanismo twist.

## SH 1085

BOLÍGRAFO SINAI



A

## SH 1340

BOLÍGRAFO ROA



Y

## SH 1590

BOLÍGRAFO LANTE



V

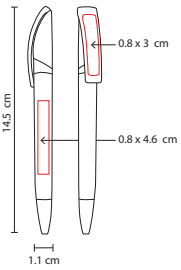

**Material:** Plástico  
**Medida:** 1.1 x 14.5 cm  
**Área de Impresión:** 0.8 x 4.6 cm Barril /  
0.8 x 3 cm Clip  
**Técnica de Impresión:** Serigrafía  
**Colores:** A/N/O/R/V  
**Tinta:** Negra

Mecanismo twist.



R

O

V

N

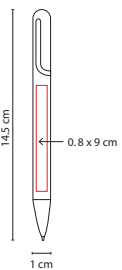

**Material:** Plástico  
**Medida:** 1 x 14.5 cm  
**Área de Impresión:** 0.8 x 9 cm  
**Técnica de Impresión:** Serigrafía  
**Colores:** A/B/N/O/R/V/Y  
**Tinta:** Negra

Mecanismo twist.



B

O

N

A

R

V

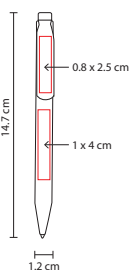

**Material:** Plástico  
**Medida:** 1.2 x 14.7 cm  
**Área de Impresión:** 1 x 4 cm Barril /  
0.8 x 2.5 cm Clip  
**Técnica de Impresión:** Serigrafía  
**Colores:** A/B/O/P/R/V  
**Tinta:** Negra

Mecanismo pulsador. Barril triangular.



P

B

A

O

R

## SH 2550

BOLÍGRAFO SONIX



O



V



R



A

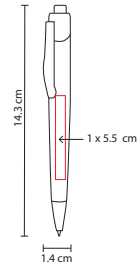

**Material:** Plástico  
**Medida:** 1.4 x 14.3 cm  
**Área de Impresión:** 1 x 5.5 cm  
**Técnica de Impresión:** Serigrafía  
**Colores:** A/O/R/V  
**Tinta:** Negra

Mecanismo pulsador.

## SH 1160

BOLÍGRAFO DAKOTA



Y



N



V



A



O



R

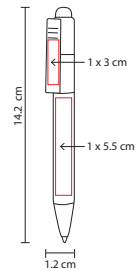

**Material:** Plástico  
**Medida:** 1.2 x 14.2 cm  
**Área de Impresión:** 1 x 5.5 cm Barril /  
1 x 3 cm Clip  
**Técnica de Impresión:** Serigrafía  
**Colores:** A/N/O/R/V/Y  
**Tinta:** Negra

Mecanismo pulsador.

## SH 3100

BOLÍGRAFO INFINITY



AT



RT



VT



YT



BT



OT

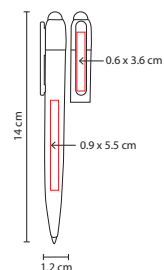

**Material:** Plástico  
**Medida:** 1.2 x 14 cm  
**Área de Impresión:** 0.9 x 5.5 cm Barril /  
0.6 x 3.6 cm Clip  
**Técnica de Impresión:** Serigrafía  
**Colores:** AT/BT/OT/RT/VT/YT  
**Tinta:** Negra

Mecanismo pulsador.

## SH 1330

BOLÍGRAFO NAMIBE

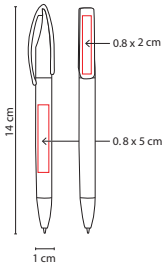

**Material:** Plástico  
**Medida:** 1 x 14 cm  
**Área de Impresión:** 0.8 x 5 cm Barril /  
0.8 x 2 cm Clip  
**Técnica de Impresión:** Serigrafía  
**Colores:** A/M/R/V Metalizados  
**Tinta:** Negra

Mecanismo twist.



## SH 1325

BOLÍGRAFO VHORI

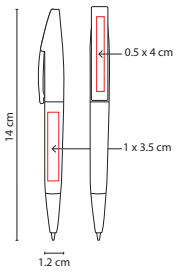

**Material:** Plástico  
**Medida:** 1.2 x 14 cm  
**Área de Impresión:** 1 x 3.5 cm Barril /  
0.5 x 4 cm Clip  
**Técnica de Impresión:** Serigrafía  
**Colores:** A/N/O/R/V  
**Tinta:** Negra

Mecanismo twist.



## SH 1315

BOLÍGRAFO OLEH

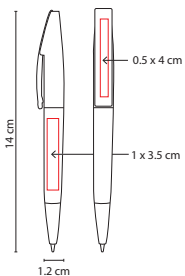

**Material:** Plástico  
**Medida:** 1.2 x 14 cm  
**Área de Impresión:** 1 x 3.5 cm Barril /  
0.5 x 4 cm Clip  
**Técnica de Impresión:** Serigrafía  
**Colores:** A/AC/M/N/O/R/V  
**Tinta:** Negra

Mecanismo twist.

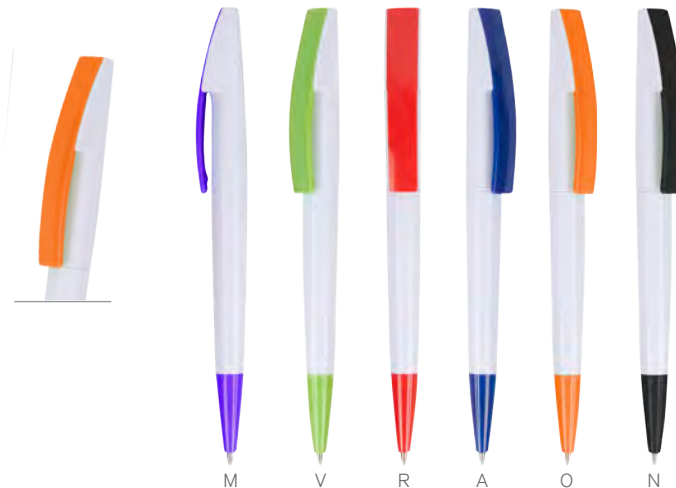

## SH 1440

### BOLÍGRAFO BALTIC



R



V



S

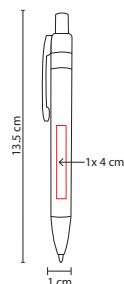

**Material:** Plástico  
**Medida:** 1 x 13.5 cm  
**Área de Impresión:** 1 x 4 cm  
**Técnica de Impresión:** Serigrafía  
**Colores:** R/S/V  
**Tinta:** Negra

Mecanismo pulsador.

## SH 1190

### BOLÍGRAFO BRICK



A



R



S

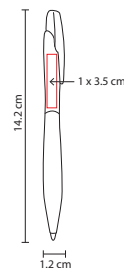
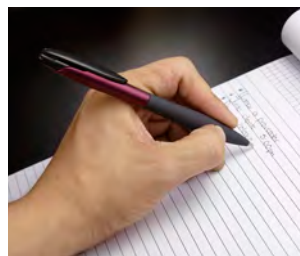

**Material:** Plástico  
**Medida:** 1.2 x 14.2 cm  
**Área de Impresión:** 1 x 3.5 cm  
**Técnica de Impresión:** Serigrafía  
**Colores:** A/R/S  
**Tinta:** Negra

Mecanismo pulsador.

## SH 1240

### BOLÍGRAFO ELOY



O



V



A



N



Y



R

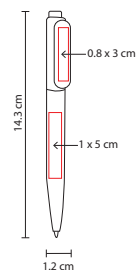

**Material:** Plástico  
**Medida:** 1.2 x 14.3 cm  
**Área de Impresión:** 1 x 5 cm Barril / 0.8 x 3 cm Clip  
**Técnica de Impresión:** Serigrafía  
**Colores:** A/N/O/R/V/Y  
**Tinta:** Negra

Mecanismo pulsador.



## SH 1345

BOLÍGRAFO OREL

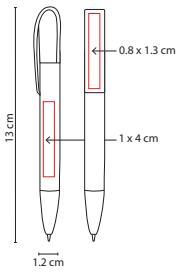

**Material:** Plástico  
**Medida:** 1,2 x 13 cm  
**Área de Impresión:** 1 x 4 cm Barril /  
0,8 x 1,3 cm Clip  
**Técnica de Impresión:** Serigrafía  
**Colores:** A/B/N/O/R  
**Tinta:** Negra

Mecanismo twist.

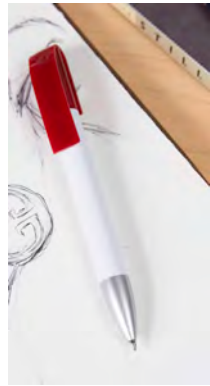

## SH 1035

BOLÍGRAFO TXT

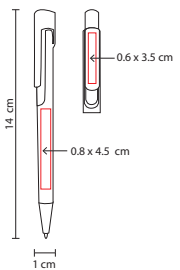

**Material:** Plástico  
**Medida:** 1 x 14 cm  
**Área de Impresión:** 0,8 x 4,5 cm Barril /  
0,6 x 3,5 cm Clip  
**Técnica de Impresión:** Serigrafía  
**Colores:** A/M/N/O/R/V  
**Tinta:** Negra

Mecanismo pulsador.



## SH 1025

BOLÍGRAFO TRENDY

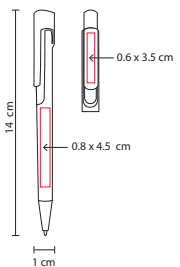

**Material:** Plástico  
**Medida:** 1 x 14 cm  
**Área de Impresión:** 0,8 x 4,5 cm Barril /  
0,6 x 3,5 cm Clip  
**Técnica de Impresión:** Serigrafía  
**Colores:** A/M/O/R/S/V Metalizados  
**Tinta:** Negra

Mecanismo pulsador.



## SH 1205

BOLÍGRAFO LEVANT



R



A



Y



V

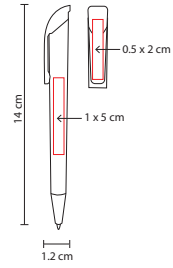

**Material:** Plástico  
**Medida:** 1.2 x 14 cm  
**Área de Impresión:** 1 x 5 cm Barril /  
 0.5 x 2 cm Clip  
**Técnica de Impresión:** Serigrafía  
**Colores:** A/R/V/Y  
**Tinta:** Negra

Mecanismo pulsador.

## SH 1519

BOLÍGRAFO BOMBAY



A



R



N



B

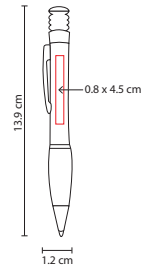

**Material:** Plástico  
**Medida:** 1.2 x 13.9 cm  
**Área de Impresión:** 0.8 x 4.5 cm  
**Técnica de Impresión:** Serigrafía  
**Colores:** A/B/N/R  
**Tinta:** Negra

Mecanismo pulsador.

## SH 1375

BOLÍGRAFO MOSSLEY



R



Y



O



N



P



S



B



A



V

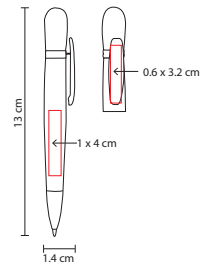

**Material:** Plástico  
**Medida:** 1.4 x 13 cm  
**Área de Impresión:** 1 x 4 cm Barril /  
 0.6 x 3.2 cm Clip  
**Técnica de Impresión:** Serigrafía  
**Colores:** A/B/N/O/P/R/S/V/Y  
**Tinta:** Negra

Mecanismo twist.

## SH 1055

BOLÍGRAFO EBEN

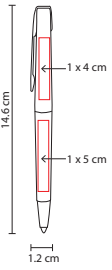

**Material:** Plástico  
**Medida:** 1,2 x 14,6 cm  
**Área de Impresión:** 1 x 5 cm  
**Técnica de Impresión:** Serigrafía /  
Tampografía  
**Colores:** A/N/O/R/V  
**Tinta:** Negra

Mecanismo twist.

## SH 1140

BOLÍGRAFO DEO

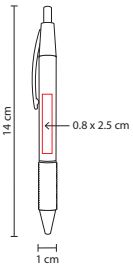

**Material:** Plástico  
**Medida:** 1 x 14 cm  
**Área de Impresión:** 0,8 x 2,5 cm  
**Técnica de Impresión:** Serigrafía  
**Colores:** A/N/O/R/V/Y  
**Tinta:** Negra

Mecanismo pulsador.

## SH 2100

BOLÍGRAFO LACEY

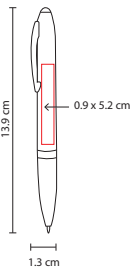

**Material:** Plástico  
**Medida:** 1,3 x 13,9 cm  
**Área de Impresión:** 0,9 x 5,2 cm  
**Técnica de Impresión:** Serigrafía  
**Colores:** A/N/O/R/V/Y  
**Tinta:** Negra

Mecanismo twist.

## SH 1507

### BOLÍGRAFO HAMBURGO



O



R



V



A

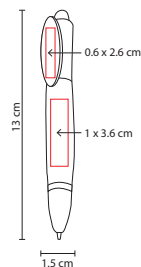

**Material:** Plástico  
**Medida:** 1.5 x 13 cm  
**Área de Impresión:** 1 x 3.6 cm Barril /  
0.6 x 2.6 cm Clip  
**Técnica de Impresión:** Serigrafía  
**Colores:** A/O/R/V  
**Tinta:** Negra

Mecanismo pulsador.

## SH 1540

### BOLÍGRAFO TIBET



V



R



Y



B



O

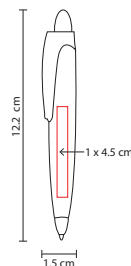

**Material:** Plástico  
**Medida:** 1.5 x 12.2 cm  
**Área de Impresión:** 1 x 4.5 cm  
**Técnica de Impresión:** Serigrafía  
**Colores:** B/O/R/V/Y  
**Tinta:** Negra

Mecanismo pulsador.

## SH 1550

### BOLÍGRAFO ABAYA



Y



A



V



R



O



N

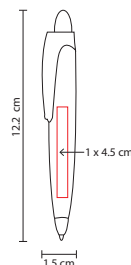

**Material:** Plástico  
**Medida:** 1.5 x 12.2 cm  
**Área de Impresión:** 1 x 4.5 cm  
**Técnica de Impresión:** Serigrafía  
**Colores:** A/N/O/R/V/Y  
**Tinta:** Negra

Mecanismo pulsador.

## SH 1080

BOLÍGRAFO MARDUK



VT

RT

OT

AT



PT

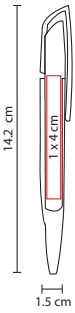

**Material:** Plástico  
**Medida:** 1.5 x 14.2 cm  
**Área de Impresión:** 1 x 4 cm  
**Técnica de Impresión:** Tampografía  
**Colores:** AT/OT/PT/RT/VT  
**Tinta:** Negra

Mecanismo pulsador.



A

O

N

R

## SH 9010

BOLÍGRAFO CLIP UP



Y

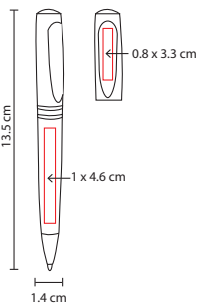

**Material:** Plástico  
**Medida:** 1.4 x 13.5 cm  
**Área de Impresión:** 1 x 4.6 cm Barril / 0.8 x 3.3 cm Clip  
**Técnica de Impresión:** Serigrafía  
**Colores:** A/AC/M/N/O/P/R/S/V/Y  
**Tinta:** Negra

Mecanismo twist para ocultar el clip.



P

S

AC

V

M

## SH 3620

BOLÍGRAFO BUNGIE



V

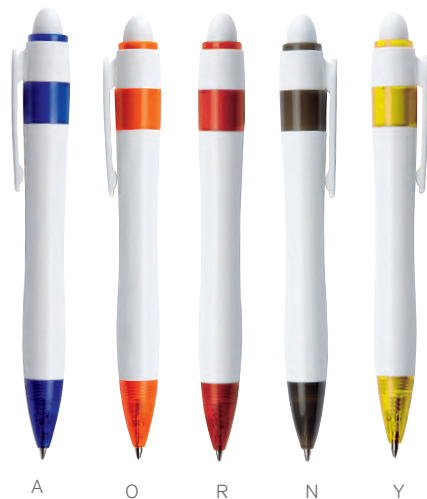

A

O

R

N

Y

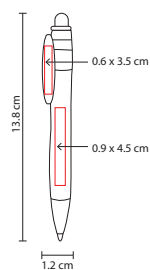

**Material:** Plástico

**Medida:** 1.2 x 13.8 cm

**Área de Impresión:** 0.9 x 4.5 cm Barril / 0.6 x 3.5 cm Clip

**Técnica de Impresión:** Serigrafía

**Colores:** A/N/O/R/V/Y

**Tinta:** Negra

Mecanismo pulsador.

## SH 1530

BOLÍGRAFO DESTINY



P



R

O

N

A

V

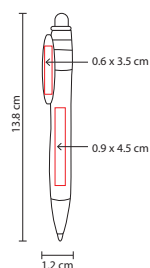

**Material:** Plástico

**Medida:** 1.2 x 13.8 cm

**Área de Impresión:** 0.9 x 4.5 cm Barril / 0.6 x 3.5 cm Clip

**Técnica de Impresión:** Serigrafía

**Colores:** A/N/O/P/R/V

**Tinta:** Negra

Mecanismo pulsador.

## SH 1690

BOLÍGRAFO MEGAN



Y



V

N

O

A

R

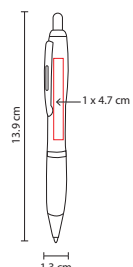

**Material:** Plástico

**Medida:** 1.3 x 13.9 cm

**Área de Impresión:** 1 x 4.7 cm

**Técnica de Impresión:** Serigrafía

**Colores:** A/N/O/R/V/Y

**Tinta:** Negra

Mecanismo pulsador.

## SH 1075

### BOLÍGRAFO TURÍN

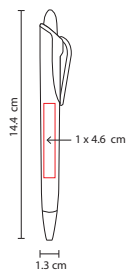

**Material:** Plástico / Clip Metálico  
**Medida:** 1,3 x 14,4 cm  
**Área de Impresión:** 1 x 4,6 cm  
**Técnica de Impresión:** Serigrafía  
**Colores:** A/N/O/R/V/Y  
**Tinta:** Negra

Mecanismo pulsador.

## SH 1070

### BOLÍGRAFO CELIO

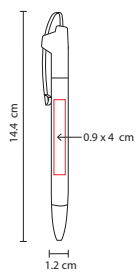

**Material:** Plástico / Clip Metálico  
**Medida:** 1,2 x 14,4 cm  
**Área de Impresión:** 0,9 x 4 cm  
**Técnica de Impresión:** Serigrafía  
**Colores:** A/G/N/O/R/S/V  
**Tinta:** Negra

Mecanismo pulsador.

## SH 1045

### BOLÍGRAFO VOITTA

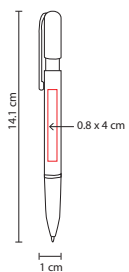

**Material:** Plástico  
**Medida:** 1 x 14,1 cm  
**Área de Impresión:** 0,8 x 4 cm  
**Técnica de Impresión:** Serigrafía  
**Colores:** A/O/R/V/Y  
**Tinta:** Negra

Mecanismo pulsador.

## GEL 001

BOLÍGRAFO AQUAGEL



N



R

A

B

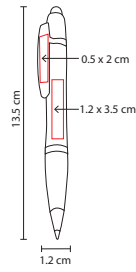

**Material:** Plástico  
**Medida:** 1.2 x 13.5 cm  
**Área de Impresión:** 1.2 x 3.5 Barril /  
0.5 x 2 cm Clip  
**Técnica de Impresión:** Serigrafía  
**Colores:** A/B/N/R  
**Tinta:** Gel Negra

Mecanismo pulsador.

## GEL 050

BOLÍGRAFO  
HIDROGEL



V



N

A

R

O

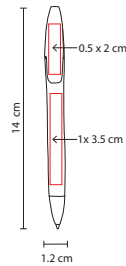

**Material:** Plástico  
**Medida:** 1.2 x 14 cm  
**Área de Impresión:** 1 x 3.5 cm Barril /  
0.5 x 2 cm Clip  
**Técnica de Impresión:** Serigrafía  
**Colores:** A/N/O/R/V  
**Tinta:** Gel Negra

Mecanismo twist.

## SH 1180

BOLÍGRAFO CROSS  
GEL



O



A

V

S

R

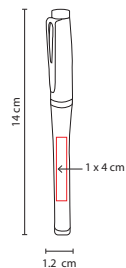

**Material:** Plástico  
**Medida:** 1.2 x 14 cm  
**Área de Impresión:** 1 x 4 cm  
**Técnica de Impresión:** Serigrafía  
**Colores:** A/O/R/S/V Metalizados  
**Tinta:** Gel Negra

Bolígrafo con tapón.



## ECO 001

### BOLÍGRAFO ECOLÓGICO

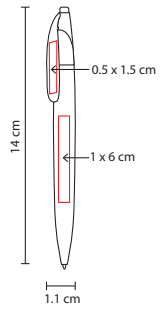

A



V



N

**Material:** Maíz  
**Medida:** 1.1 x 14 cm  
**Área de Impresión:** 1 x 6 cm Barril /  
0.5 x 1.5 cm Clip  
**Técnica de Impresión:** Serigrafía  
**Colores:** A/N/R/V  
**Tinta:** Negra

Mecanismo pulsador. Material Eco-Friendly

## ECO 005

### BOLÍGRAFO LEAF

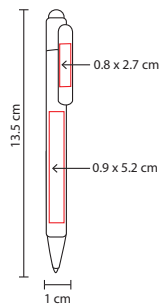

O



A



N



R

**Material:** Cartón / Plástico  
**Medida:** 1 x 13.5 cm  
**Área de Impresión:** 0.9 x 5.2 cm Barril /  
0.8 x 2.7 cm Clip  
**Técnica de Impresión:** Serigrafía  
**Colores:** A/N/O/R/V  
**Tinta:** Negra

Mecanismo pulsador. Material Eco-Friendly

M 63282

LLAVERO SQUARE

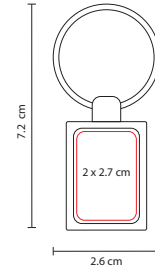
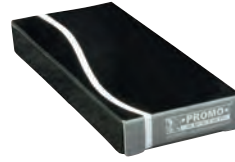

**Material:** Metal  
**Medida:** 2.6 x 7.2 cm  
**Área de Impresión:** 2 x 2.7 cm  
**Técnica de Impresión:** Goteado en Resina / Grabado Espejo / Serigrafía  
**Colores:** Plata

Incluye caja individual.

M 5530

LLAVERO RADISS

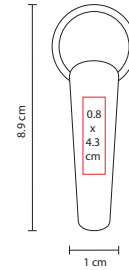
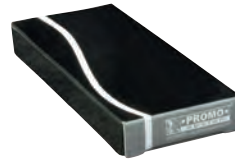

**Material:** Hule / Metal  
**Medida:** 1 x 8.9 cm  
**Área de Impresión:** 0.8 x 4.3 cm  
**Técnica de Impresión:** Láser  
**Colores:** A/N/R

Incluye caja individual.

M 63280

LLAVERO LABORO

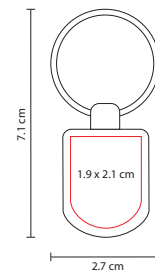
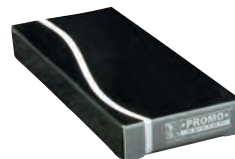

**Material:** Metal  
**Medida:** 2.7 x 7.1 cm  
**Área de Impresión:** 1.9 x 2.1 cm  
**Técnica de Impresión:** Goteado en Resina / Grabado Espejo / Serigrafía  
**Colores:** Plata

Incluye caja individual.



M 5715

LLAVERO ATLANTIS



V



N



O

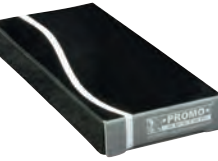

R



A

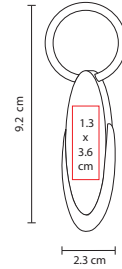

**Material:** Metal / Plástico  
**Medida:** 2.3 x 9.2 cm  
**Área de Impresión:** 1.3 x 3.6 cm  
**Técnica de Impresión:** Pantógrafo  
**Colores:** A/N/O/R/V

Incluye caja individual.

M 6232

LLAVERO ASTORIA

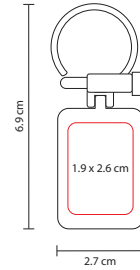

**Material:** Metal  
**Medida:** 2.7 x 6.9 cm  
**Área de Impresión:** 1.9 x 2.6 cm  
**Técnica de Impresión:** Goteado en Resina / Grabado Espejo  
**Colores:** Plata

Incluye estuche especial.

K 256

LLAVERO IBIZA



R



A



B

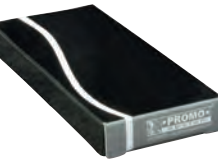

V



Y

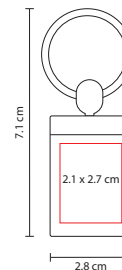

**Material:** Metal / Plástico  
**Medida:** 2.8 x 7.1 cm  
**Área de Impresión:** 2.1 x 2.7 cm  
**Técnica de Impresión:** Serigrafía  
**Colores:** A/B/R/V/Y

Incluye caja individual.

## M 2000

### LLAVERO TRUCK

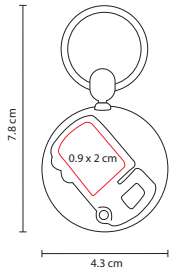

**Material:** Metal / Plástico  
**Medida:** 4.3 x 7.8 cm  
**Área de Impresión:** 0.9 x 2 cm  
**Técnica de Impresión:** Goteado en Resina  
**Colores:** B/N

Incluye caja individual.

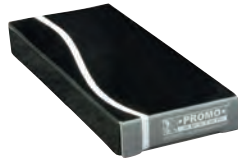

B



N

## M 1080

### LLAVERO HOME

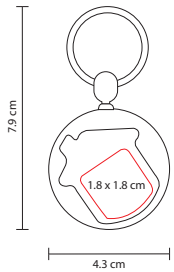

**Material:** Metal / Plástico  
**Medida:** 4.3 x 7.9 cm  
**Área de Impresión:** 1.8 x 1.8 cm  
**Técnica de Impresión:** Goteado en Resina  
**Colores:** B/N

Incluye caja individual.

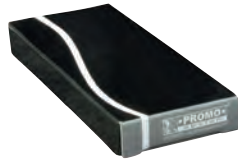

N



B

## M 1090

### LLAVERO HUMAN

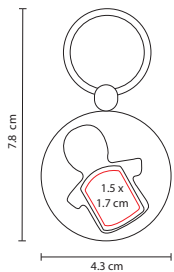

**Material:** Metal / Plástico  
**Medida:** 4.3 x 7.8 cm  
**Área de Impresión:** 1.5 x 1.7 cm  
**Técnica de Impresión:** Goteado en Resina  
**Colores:** B/N

Incluye caja individual.

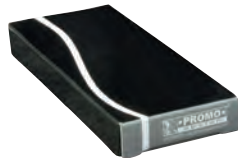

B



N

M 3402

LLAVERO SAGARA

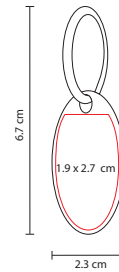

**Materia:** Metal  
**Medida:** 2.3 x 6.7 cm  
**Área de Impresión:** 1.9 x 2.7 cm  
**Técnica de Impresión:** Goteado en Resina  
**Colores:** Plata

M 5813

LLAVERO CASPIO

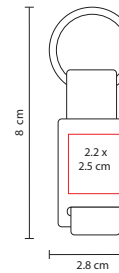
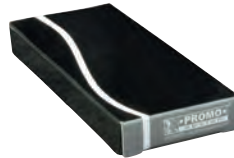

**Materia:** Metal / Tela  
**Medida:** 2.8 x 8 cm  
**Área de Impresión:** 2.2 x 2.5 cm  
**Técnica de Impresión:** Pantógrafo  
**Colores:** A/N/R/V/Y

R

N

A

V

Y

Incluye caja individual.

M 3401

LLAVERO VOSTOK

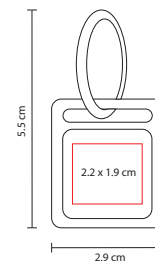

**Materia:** Metal  
**Medida:** 2.9 x 5.5 cm  
**Área de Impresión:** 2.2 x 1.9 cm  
**Técnica de Impresión:** Goteado en Resina  
**Colores:** Plata

## M 4550

### LLAVERO BEXLEY

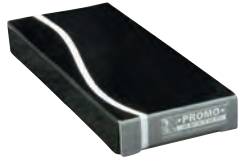
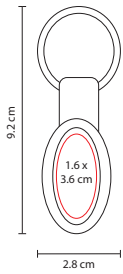

N



O



A



V



R

**Material:** Hule / Metal  
**Medida:** 2.8 x 9.2 cm  
**Área de Impresión:** 1.6 x 3.6 cm  
**Técnica de Impresión:** Serigrafía  
**Colores:** A/N/O/R/V

Incluye caja individual.

## K 6550

### LLAVERO GUN

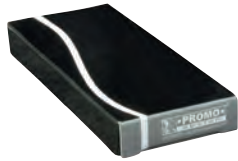
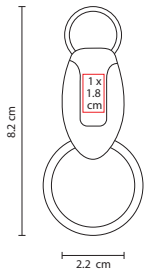

**Material:** Metal  
**Medida:** 2.2 x 8.2 cm  
**Área de Impresión:** 1 x 1.8 cm  
**Técnica de Impresión:** Pantógrafo  
**Colores:** Cromo con Gris Metalizado

Llavero con 2 arillos separables. Incluye caja individual.

## M 6010

### LLAVERO LOMBOK

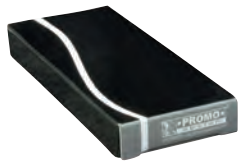
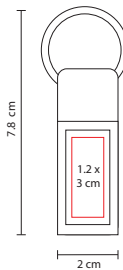

N



A



R



V

**Material:** Curpiel / Metal  
**Medida:** 2 x 7.8 cm  
**Área de Impresión:** 1.2 x 3 cm  
**Técnica de Impresión:** Láser / Pantógrafo  
**Colores:** A/N/R/V

Incluye caja individual.

M 2030

LLAVERO STAR

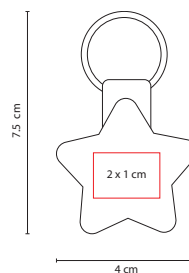
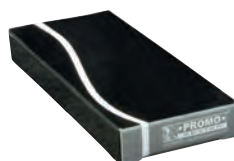

**Material:** Curpiel / Metal  
**Medida:** 4 x 7.5 cm  
**Área de Impresión:** 2 x 1 cm  
**Técnica de Impresión:** Láser  
**Colores:** Negro

Incluye caja individual.

M 2035

LLAVERO LEGACY

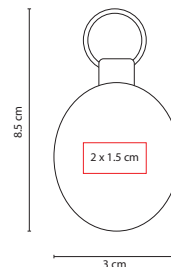
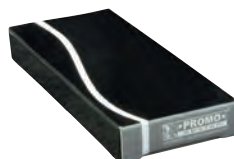

**Material:** Curpiel / Metal  
**Medida:** 3 x 8.5 cm  
**Área de Impresión:** 2 x 1.5 cm  
**Técnica de Impresión:** Láser / Pantógrafo  
**Colores:** Negro

Incluye caja individual.

M 5010

LLAVERO KRONOS

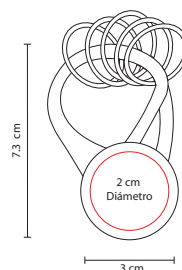
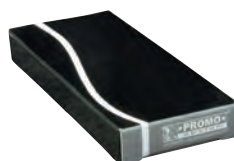

**Material:** Hule / Metal  
**Medida:** 3 x 7.3 cm  
**Área de Impresión:** 2 cm Diámetro  
**Técnica de Impresión:** Pantógrafo  
**Colores:** A/N/R

Incluye 5 arillos y caja individual.

A

N

R



## M 2025

### LLAVERO AUTO

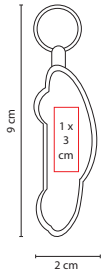

**Material:** Curpiel / Metal  
**Medida:** 2 x 9 cm  
**Área de Impresión:** 1 x 3 cm  
**Técnica de Impresión:** Láser  
**Colores:** Negro

Incluye caja individual.

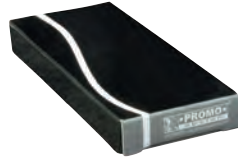

## M 7350

### LLAVERO MATISSE

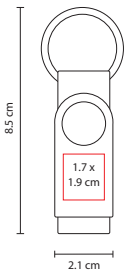

**Material:** Curpiel / Metal  
**Medida:** 2.1 x 8.5 cm  
**Área de Impresión:** 1.7 x 1.9 cm  
**Técnica de Impresión:** Pantógrafo  
**Colores:** A/N/O/R/V

Incluye caja individual.

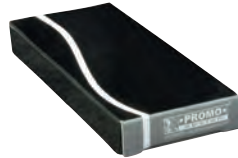

A



N



O



V



R

## M 2020

### LLAVERO CASA RUMA

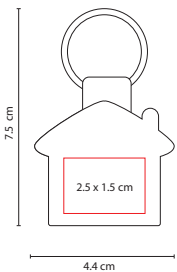

**Material:** Curpiel / Metal  
**Medida:** 4.4 x 7.5 cm  
**Área de Impresión:** 2.5 x 1.5 cm  
**Técnica de Impresión:** Láser  
**Colores:** Negro

Incluye caja individual.

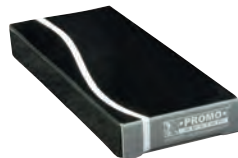

M 64104-12

LLAVERO ARGOLLA TRIPLE

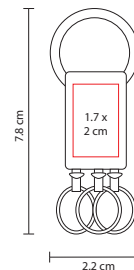
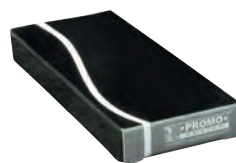

**Material:** Metal  
**Medida:** 2.2 x 7.8 cm  
**Área de Impresión:** 1.7 x 2 cm  
**Técnica de Impresión:** Pantógrafo  
**Colores:** Plata

Incluye 3 arillos y caja individual.

M 6850

LLAVERO SURAT

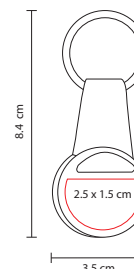
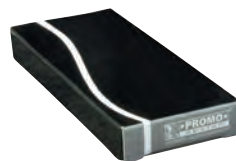

**Material:** Hule / Metal  
**Medida:** 3.5 x 8.4 cm  
**Área de Impresión:** 2.5 x 1.5 cm  
**Técnica de Impresión:** Láser  
**Colores:** A/N/R

Incluye caja individual.

M 63600

LLAVERO CLASSIC

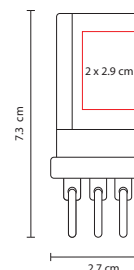

**Material:** Metal  
**Medida:** 2.7 x 7.3 cm  
**Área de Impresión:** 2 x 2.9 cm  
**Técnica de Impresión:** Pantógrafo  
**Colores:** Cromo con Negro

Incluye 3 arillos y estuche especial.

M 3100

LLAVERO ARUM

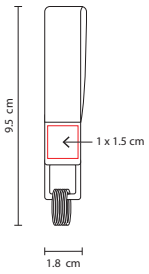

**Material:** Curpiel / Metal  
**Medida:** 1.8 x 9.5 cm  
**Área de Impresión:** 1 x 1.5 cm  
**Técnica de Impresión:** Láser  
**Colores:** Negro

Incluye 4 arillos y estuche especial.



M 2040

LLAVERO LOVE

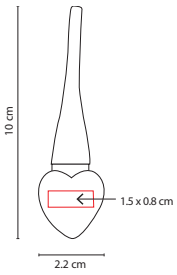

**Material:** Hule / Metal  
**Medida:** 2.2 x 10 cm  
**Área de Impresión:** 1.5 x 0.8 cm  
**Técnica de Impresión:** Láser  
**Colores:** Rojo

Incluye caja individual.

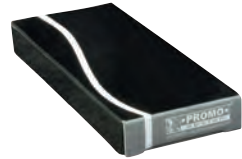

M 3150

LLAVERO CELTA

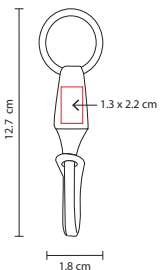

**Material:** Hule / Metal  
**Medida:** 1.8 x 12.7 cm  
**Área de Impresión:** 1.3 x 2.2 cm  
**Técnica de Impresión:** Láser  
**Colores:** Negro

Incluye estuche especial.



K 6470

LLAVERO PRISMA

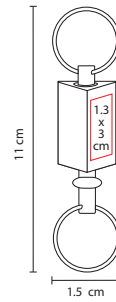
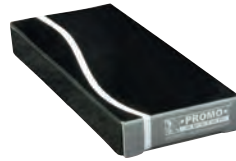

**Material:** Metal  
**Medida:** 1.5 x 11 cm  
**Área de Impresión:** 1.3 x 3 cm  
**Técnica de Impresión:** Pantógrafo  
**Colores:** Níquel

Incluye 2 arillos separables y caja individual.

M 3500

LLAVERO ARKADI

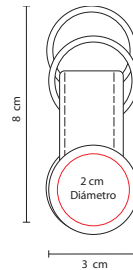

**Material:** Metal  
**Medida:** 3 x 8 cm  
**Área de Impresión:** 2 cm Diámetro  
**Técnica de Impresión:** Láser  
**Colores:** Negro

Incluye 2 arillos y estuche especial.

K 63290

LLAVERO  
CASA-COCHE

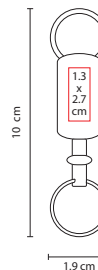
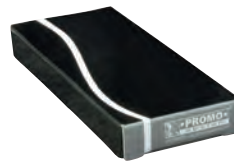

**Material:** Metal  
**Medida:** 1.9 x 10 cm  
**Área de Impresión:** 1.3 x 2.7 cm  
**Técnica de Impresión:** Pantógrafo  
**Colores:** Plata

Incluye 2 arillos separables y caja individual.

## M 1040

### LLAVERO SWAP

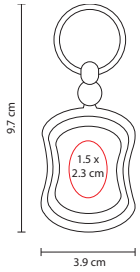

**Material:** Plástico  
**Medida:** 3.9 x 9.7 cm  
**Área de Impresión:** 1.5 x 2.3 cm  
**Técnica de Impresión:** Goteado en Resina  
**Colores:** A/N/R

Incluye caja individual.

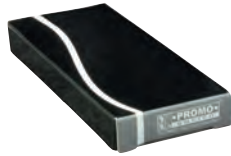

A



N



R

## M 1070

### LLAVERO MOON

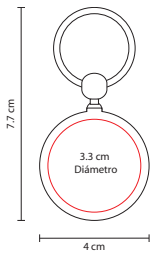

**Material:** Plástico  
**Medida:** 4 x 7.7 cm  
**Área de Impresión:** 3.3 cm Diámetro  
**Técnica de Impresión:** Goteado en Resina  
**Colores:** A/N/O/R/V

Incluye caja individual.

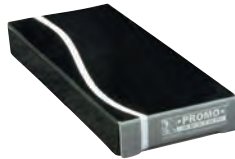

N



R



O



V



A

## M 1060

### LLAVERO PÉNDULO

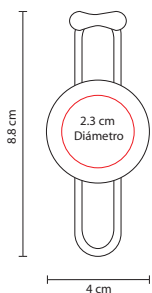

**Material:** Plástico  
**Medida:** 4 x 8.8 cm  
**Área de Impresión:** 2.3 cm Diámetro  
**Técnica de Impresión:** Goteado en Resina  
**Colores:** A/N/R

Incluye caja individual.

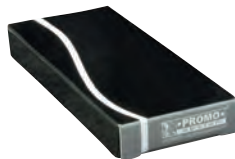

A



R



N

M 1030

LLAVERO CAMEL



N



R



O



V



A

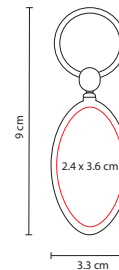
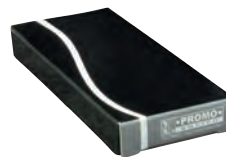

**Material:** Plástico  
**Medida:** 3.3 x 9 cm  
**Área de Impresión:** 2.4 x 3.6 cm  
**Técnica de Impresión:** Goteado en Resina  
**Colores:** A/N/O/R/V

Incluye caja individual.

M 1050

LLAVERO DISH



R



A



N

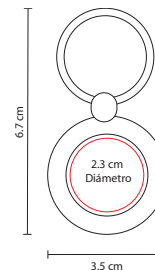
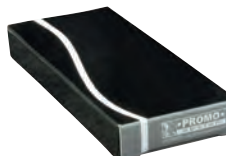

**Material:** Plástico  
**Medida:** 3.5 x 6.7 cm  
**Área de Impresión:** 2.3 cm Diámetro  
**Técnica de Impresión:** Goteado en Resina  
**Colores:** A/N/R

Incluye caja individual.

K 180

LLAVERO CON PAÑUELO

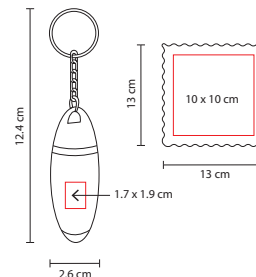

**Material:** Plástico / Microfibra  
**Medida:** 2.6 x 12.4 cm Llavero / 13 x 13 cm Microfibra  
**Área de Impresión:** 1.7 x 1.9 cm Llavero / 10 x 10 cm Microfibra  
**Técnica de Impresión:** Serigrafía / Tampografía  
**Colores:** Blanco Frosty

Llavero con pañuelo de microfibra.

## K 150

### LLAVERO PILL

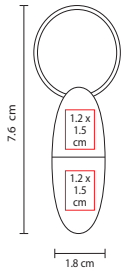

**Material:** Metal / Plástico  
**Medida:** 1.8 x 7.6 cm  
**Área de Impresión:** 1.2 x 1.5 cm  
**Técnica de Impresión:** Láser / Tampografía  
**Colores:** A/N/R

Llavero pastillero.



## M 2045

### LLAVERO ALORA

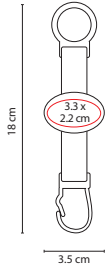

**Material:** Plástico / Silicón  
**Medida:** 3.5 x 18 cm  
**Área de Impresión:** 3.3 x 2.2 cm  
**Técnica de Impresión:** Goteado en Resina  
**Colores:** A/O/R/V

Llavero de silicón elástico. Incluye gancho.

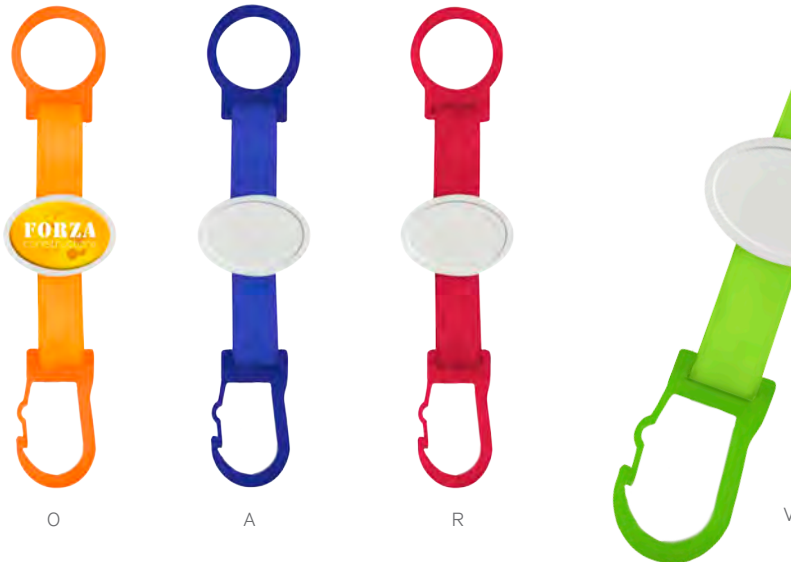

## K 100

### LLAVERO ANTI-STRESS

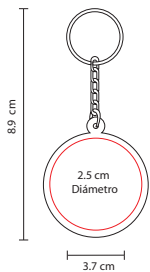

**Material:** PU  
**Medida:** 3.7 x 8.9 cm  
**Área de Impresión:** 2.5 cm Diámetro  
**Técnica de Impresión:** Tampografía  
**Colores:** A/R/S

Llavero con pelota anti-stress.



**K 231**

LLAVERO CASTEL



N



V

A

R

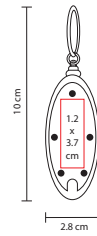

**Materia:** Plástico  
**Medida:** 2.8 x 10 cm  
**Área de Impresión:** 1.2 x 3.7 cm  
**Técnica de Impresión:** Serigrafía  
**Colores:** A/N/R/V

Llavero con luz. Incluye batería.

**K 250**

LLAVERO ORBIT



R



B

A

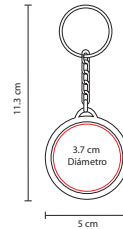

**Materia:** Plástico  
**Medida:** 5 x 11.3 cm  
**Área de Impresión:** 3.7 cm Diámetro  
**Técnica de Impresión:** Serigrafía  
**Colores:** A/B/R

Llavero con luz. Incluye batería.

**M 1010**

LLAVERO ADENIO



A



B

R

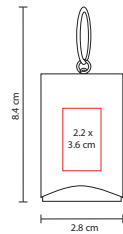

**Materia:** Plástico  
**Medida:** 2.8 x 8.4 cm  
**Área de Impresión:** 2.2 x 3.6 cm  
**Técnica de Impresión:** Serigrafía  
**Colores:** A/B/R

Llavero con luz de 1 LED.

**K 300**

LLAVERO LÁMPARA THORA



B



R

A

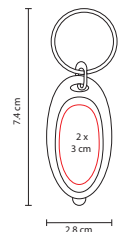

**Materia:** Plástico  
**Medida:** 2.8 x 7.4 cm  
**Área de Impresión:** 2 x 3 cm  
**Técnica de Impresión:** Serigrafía  
**Colores:** A/B/R

Llavero con luz. Incluye batería.



## LAM 001

### LÁMPARA FLUX

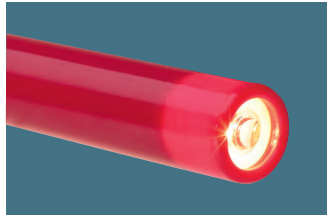
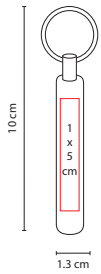

**Material:** Plástico  
**Medida:** 1.3 x 10 cm  
**Área de Impresión:** 1 x 5 cm  
**Técnica de Impresión:** Serigrafía  
**Colores:** A/B/R/S

Cuenta con llavero y lámpara. Incluye una batería (AAA).



S

A

R



B

## M 2010

### LLAVERO KAMSAR

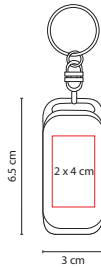

**Material:** Plástico  
**Medida:** 3 x 6.5 cm  
**Área de Impresión:** 2 x 4 cm  
**Técnica de Impresión:** Serigrafía  
**Colores:** A/B/O/R/V

Incluye luz de 1 LED. Incluye batería.



R

A

B

V



O

## M 2015

### LLAVERO BOKÉ

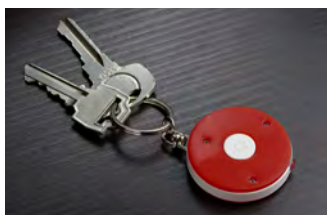
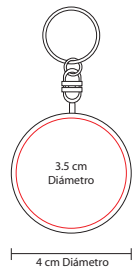

**Material:** Plástico  
**Medida:** 4 cm Diámetro  
**Área de Impresión:** 3.5 cm Diámetro  
**Técnica de Impresión:** Serigrafía  
**Colores:** A/B/O/R/V/Y

Incluye luz de 1 LED. Incluye batería.



B

A



O

Y

V



R

**K 513**

LLAVERO CON BROCHE



R



B

A

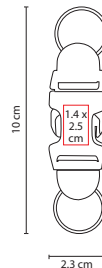

**Material:** Plástico  
**Medida:** 2.3 x 10 cm  
**Área de Impresión:** 1.4 x 2.5 cm  
**Técnica de Impresión:** Serigrafía  
**Colores:** A/B/R

Incluye 2 arillos separados.

**DPO 015**

LLAVERO BERMUDA



V

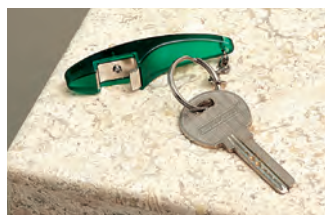

B

O

Y

R

A

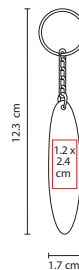

**Material:** Plástico  
**Medida:** 1.7 x 12.3 cm  
**Área de Impresión:** 1.2 x 2.4 cm  
**Técnica de Impresión:** Serigrafía  
**Colores:** A/B/O/R/V/Y

Llavero destapador.

**DPO 001**

LLAVERO LANCE



Y



R

V

N

A

B

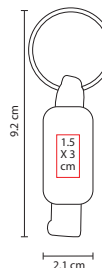

**Material:** Plástico  
**Medida:** 2.1 x 9.2 cm  
**Área de Impresión:** 1.5 x 3 cm  
**Técnica de Impresión:** Serigrafía  
**Colores:** A/B/N/R/V/Y

Llavero destapador.

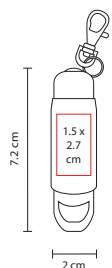

**Material:** Aluminio  
**Medida:** 2 x 7.2 cm  
**Área de Impresión:** 1.5 x 2.7 cm  
**Técnica de Impresión:** Pantógrafo / Serigrafía  
**Colores:** A/R/S

3 LEDs. Incluye gancho, destapador, cuña abrelatas y batería de botón.

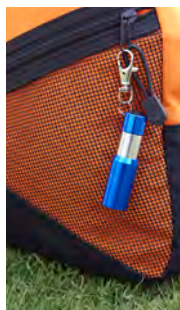
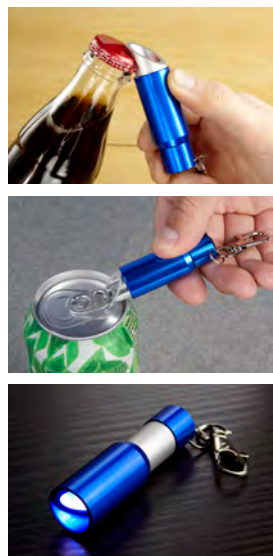

## LAM 050

LÁMPARA  
DESTAPADOR LEO



## DPO 020

LLAVERO DESTAPADOR  
CON LUZ STADIUM

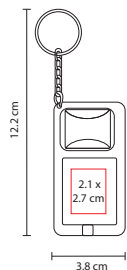

**Material:** Plástico  
**Medida:** 3.8 x 12.2 cm  
**Área de Impresión:** 2.1 x 2.7 cm  
**Técnica de Impresión:** Serigrafía  
**Colores:** A/N/R/V

Incluye baterías.

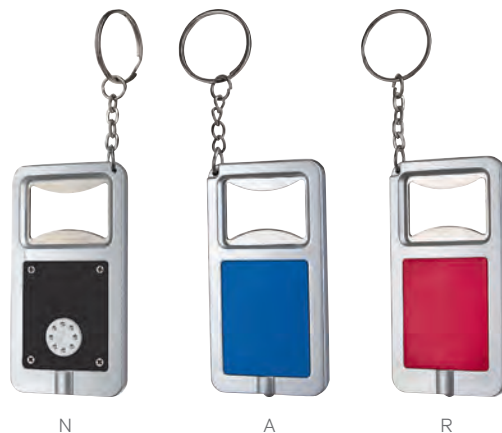

## DPO 012

LLAVERO  
DESTAPADOR KLEIN

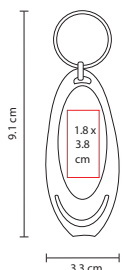

**Material:** Plástico  
**Medida:** 3.3 x 9.1 cm  
**Área de Impresión:** 1.8 x 3.8 cm  
**Técnica de Impresión:** Serigrafía  
**Colores:** A/B/R

Incluye cuña para abrir latas.



PRO 016

LLAVERO  
FLEXÓMETRO CAMIÓN

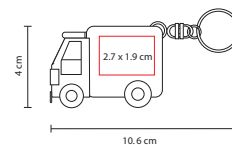

**Material:** Plástico  
**Medida:** 10.6 x 4 cm  
**Área de Impresión:** 2.7 x 1.9 cm  
**Técnica de Impresión:** Serigrafía  
**Colores:** Blanco

Cinta metálica de 1 m.

PRO 034

LLAVERO  
FLEXÓMETRO CASITA

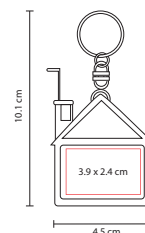

**Material:** Plástico  
**Medida:** 4.5 x 10.1 cm  
**Área de Impresión:** 3.9 x 2.4 cm  
**Técnica de Impresión:** Serigrafía  
**Colores:** Blanco

Cinta metálica de 1 m.

SH 1265

LLAVERO BOLÍGRAFO  
CON FLEXÓMETRO



A



R



B

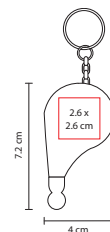

**Material:** Plástico  
**Medida:** 4 x 7.2 cm  
**Área de Impresión:** 2.6 x 2.6 cm  
**Técnica de Impresión:** Serigrafía  
**Colores:** A/B/R  
**Tinta:** Negra

Cinta metálica de 1 m.

PRO 008

LLAVERO FLEXÓMETRO  
OVALADO



RT



Y



B



BT



AT



V



O

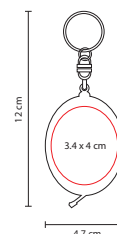

**Material:** Plástico  
**Medida:** 4.7 x 12 cm  
**Área de Impresión:** 3.4 x 4 cm  
**Técnica de Impresión:** Serigrafía  
**Colores:** AT/B/BT/O/RT/V/Y

Cinta flexible de plástico de 1.5 m.

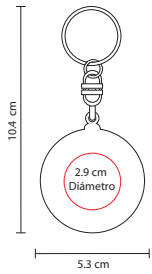

**Material:** Plástico  
**Medida:** 5.3 x 10.4 cm  
**Área de Impresión:** 2.9 cm Diámetro  
**Técnica de Impresión:** Goteado en Resina  
**Colores:** A/N/R

Cinta flexible de plástico de 1.5 m.



## PRO 005

LLAVERO  
FLEXÓMETRO WHEEL

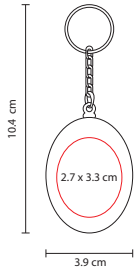

**Material:** Plástico  
**Medida:** 3.9 x 10.4 cm  
**Área de Impresión:** 2.7 x 3.3 cm  
**Técnica de Impresión:** Serigrafía  
**Colores:** Blanco

Cinta metálica de 1 m.



## PRO 002

MINI LLAVERO  
FLEXÓMETRO

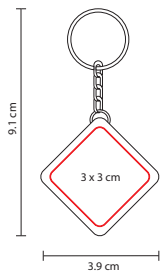

**Material:** Plástico  
**Medida:** 3.9 x 9.1 cm  
**Área de Impresión:** 3 x 3 cm  
**Técnica de Impresión:** Serigrafía  
**Colores:** A/R/S

Cinta metálica de 1 m.



## PRO 015

LLAVERO  
FLEXÓMETRO GOBI



SET 003

MINI SET DE  
CÓMPUTO HIPNOS

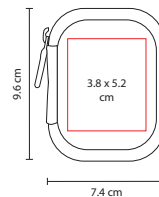
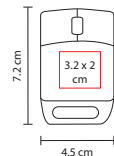

**Material:** Plástico / Poliuretano / Microfibra  
**Medida:** 7.4 x 9.6 cm Estuche / 4.5 x 7.2 cm Mouse  
**Área de Impresión:** 3.8 x 5.2 cm Estuche / 3.2 x 2 cm Mouse  
**Técnica de Impresión:** Serigrafía  
**Colores:** Negro con Plata

Incluye mini mouse con cable enrollable, mini mouse pad, instructivo y estuche.

SET 001

KIT DE CÓMPUTO  
TECKY

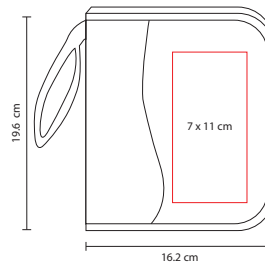
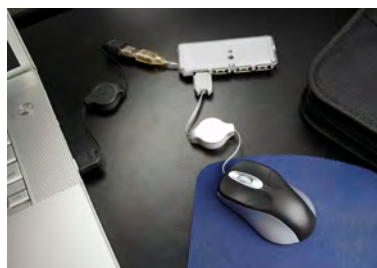

**Material:** Plástico / Tela  
**Medida:** 16.2 x 19.6 cm  
**Área de Impresión:** 7 x 11 cm  
**Técnica de Impresión:** Serigrafía  
**Colores:** Negro

Incluye HUB de 4 puertos para USB, mouse retráctil (85 cm) y extensión USB.

SET 002

SET DE CÓMPUTO  
CARDIFF

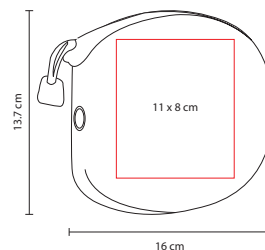

**Material:** Plástico / Tela  
**Medida:** 16 x 13.7 cm  
**Área de Impresión:** 11 x 8 cm  
**Técnica de Impresión:** Serigrafía  
**Colores:** Negro

Incluye HUB de 4 puertos para USB, mouse retráctil (85 cm) y extensión USB.



ACCESORIOS DE CÓMPUTO

MOP 001

MOUSE PAD REDONDO



V



N



B



A

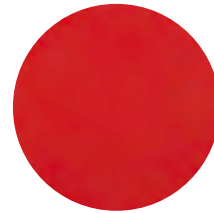

R

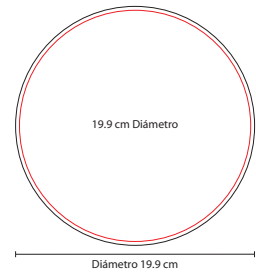

**Material:** Poliuretano  
**Medida:** 19.9 cm Diámetro  
**Área de Impresión:** 19.9 cm Diámetro  
**Técnica de Impresión:** Serigrafía  
**Colores:** A/B/N/R/V

Base antiderrapante.

MOP 004

MOUSE PAD BEAN



R



B



A



N



V

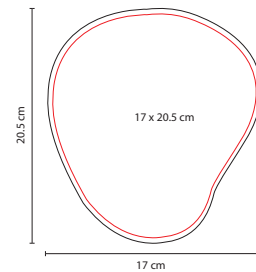

**Material:** Poliuretano  
**Medida:** 17 x 20.5 cm  
**Área de Impresión:** 17 x 20.5 cm  
**Técnica de Impresión:** Serigrafía  
**Colores:** A/B/N/R/V

Base antiderrapante.

MOP 002

MOUSE PAD RECTANGULAR



A



R



N



V



B

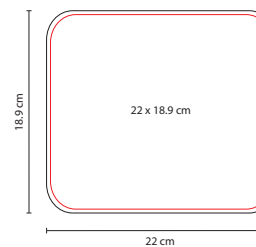

**Material:** Poliuretano  
**Medida:** 22 x 18.9 cm  
**Área de Impresión:** 22 x 18.9 cm  
**Técnica de Impresión:** Serigrafía  
**Colores:** A/B/N/R/V

Base antiderrapante.



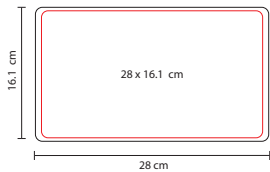

**Material:** Microfibra / Hule  
**Medida:** 28 x 16.1 cm  
**Área de Impresión:** 28 x 16.1 cm  
**Técnica de Impresión:** Serigrafía  
**Colores:** A/N/R

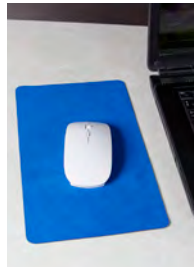
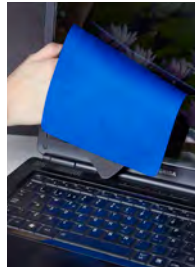

## MOP 013

MOUSE PAD VERA 3 EN 1



R

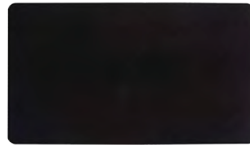

N

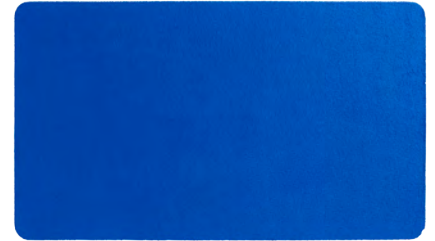

A

Mouse pad 3 en 1. Limpia pantalla, protector de teclado y mouse pad con base de hule antiderrapante.

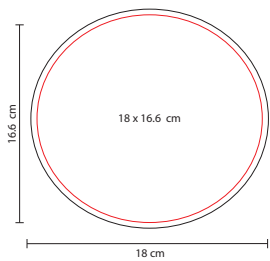

**Material:** Plástico  
**Medida:** 18 x 16.6 cm  
**Área de Impresión:** 18 x 16.6 cm  
**Técnica de Impresión:** Serigrafía  
**Colores:** Gris Oxford Metalizado



## MOP 015

MOUSE PAD SILVER



Base antiderrapante.

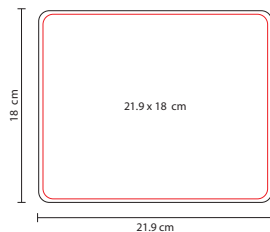

**Material:** Plástico  
**Medida:** 21.9 x 18 cm  
**Área de Impresión:** 21.9 x 18 cm  
**Técnica de Impresión:** Serigrafía  
**Colores:** A/O/R/V Metalizados



## MOP 014

MOUSE PAD DYSIS



V



A



R

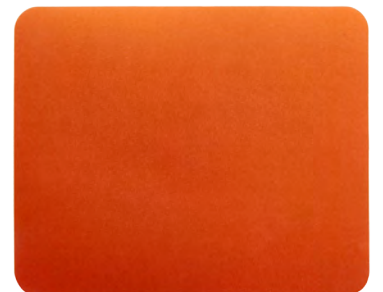

O

Base antiderrapante.

MOP 010

MOUSE PAD 3D

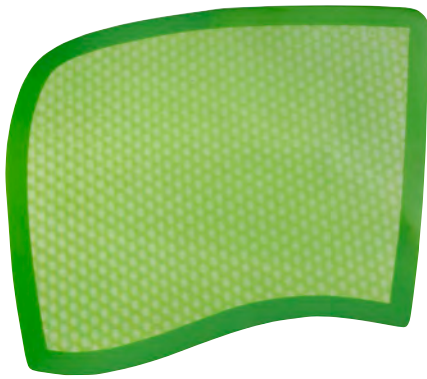

V

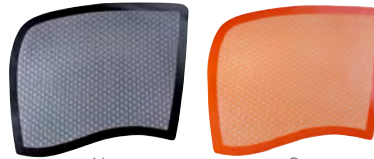

N



O



A



R

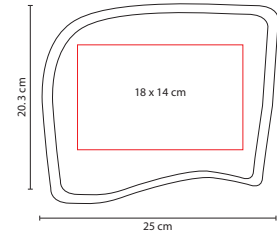

**Material:** Plástico  
**Medida:** 25 x 20.3 cm  
**Área de Impresión:** 18 x 14 cm  
**Técnica de Impresión:** Serigrafía con Tinta UV  
**Colores:** A/N/O/R/V

Efecto 3D.

MOP 007

MOUSE PAD CON GEL

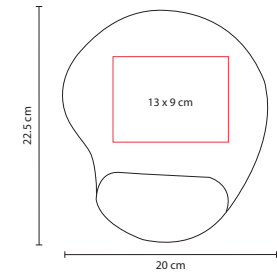

**Material:** Plástico / Tela  
**Medida:** 20 x 22.5 cm  
**Área de Impresión:** 13 x 9 cm  
**Técnica de Impresión:** Serigrafía  
**Colores:** Negro

Incluye cojín de gel para descansar la muñeca.

MOP 006

FOTO MOUSE PAD  
 CON GEL



A



R

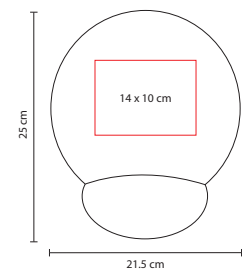

**Material:** Plástico  
**Medida:** 21.5 x 25 cm  
**Área de Impresión:** 14 x 10 cm  
**Técnica de Impresión:** Serigrafía  
**Colores:** A/R

Incluye cojín de gel para descansar la muñeca.



## MOP 012

MOUSE PAD CON  
CALCULADORA ARUBA

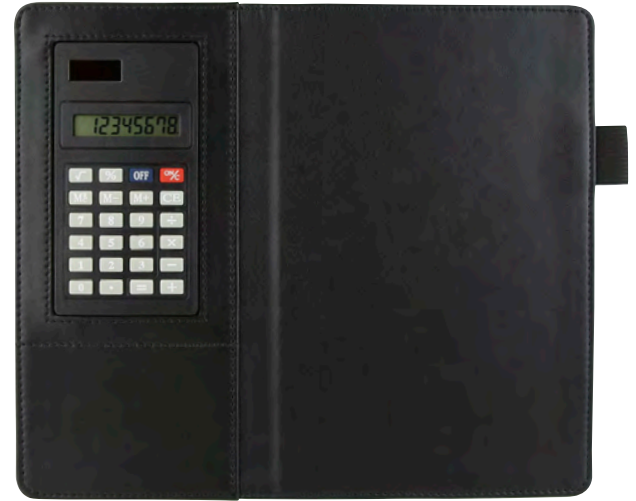
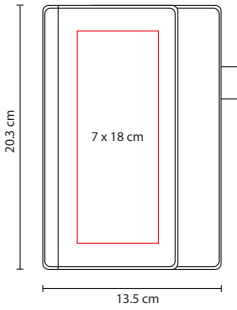

**Material:** Curpiel  
**Medida:** 13,5 x 20,3 cm  
**Área de Impresión:** 7 x 18 cm  
**Técnica de Impresión:** Láser / Serigrafía /  
 Termograbado  
**Colores:** Negro

Incluye calculadora solar de 8 dígitos y elástico para bolígrafo.



## MOP 008

MOUSE PAD  
KEYBOARD

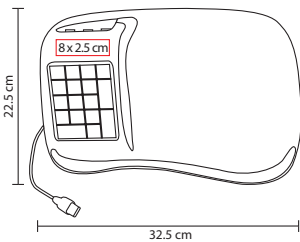

**Material:** Plástico  
**Medida:** 32,5 x 22,5 cm  
**Área de Impresión:** 8 x 2,5 cm  
**Técnica de Impresión:** Serigrafía  
**Colores:** Negro

Incluye teclado digital numérico. 3 puertos USB versión 1.1.



**MOU 060**

MOUSE TIME

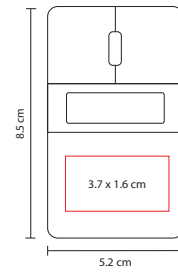

**Materia:** Plástico  
**Medida:** 5.2 x 8.5 cm  
**Área de Impresión:** 3.7 x 1.6 cm  
**Técnica de Impresión:** Serigrafía  
**Colores:** Blanco con Gris

Mouse con reloj, despertador, luz interna y fecha. Incluye cable retráctil (76 cm), baterías y caja individual.

**MOU 050**

MOUSE CON BOCINA MASDI

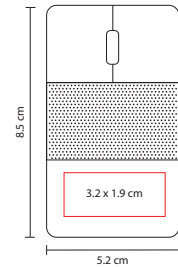

**Materia:** Plástico  
**Medida:** 5.2 x 8.5 cm  
**Área de Impresión:** 3.2 x 1.9 cm  
**Técnica de Impresión:** Serigrafía  
**Colores:** Blanco con Gris

Mouse con bocina. Incluye cable retráctil (79 cm). Incluye caja individual.

**MOU 010**

MOUSE CON LUZ

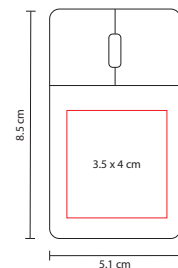

**Materia:** Plástico  
**Medida:** 5.1 x 8.5 cm  
**Área de Impresión:** 3.5 x 4 cm  
**Técnica de Impresión:** Serigrafía  
**Colores:** B/N

Incluye cable retráctil (77 cm) y estuche. Luz blanca al conectar.

B

N

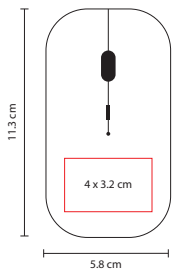

## MOU 070

MOUSE INALÁMBRICO  
ODYSSEY



**Material:** Plástico  
**Medida:** 5.8 x 11.3 cm  
**Área de Impresión:** 4 x 3.2 cm  
**Técnica de Impresión:** Serigrafía /  
Tampografía  
**Colores:** Blanco

Mouse inalámbrico. No incluye baterías.

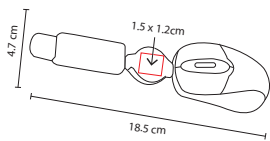

## MOU 001

MOUSE USB



**Material:** Plástico  
**Medida:** 4.7 x 18.5 cm  
**Área de Impresión:** 1.5 x 1.2 cm  
**Técnica de Impresión:** Goteado en  
Resina / Serigrafía / Tampografía  
**Colores:** Plata con Negro

Incluye estuche, cable retráctil (70 cm). 2 Puertos USB.

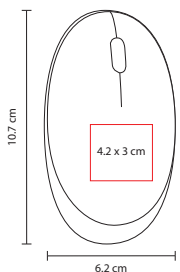

## MOU 040

MOUSE INALÁMBRICO  
CARDIEL



**Material:** Plástico  
**Medida:** 6.2 x 10.7 cm  
**Área de Impresión:** 4.2 x 3 cm  
**Técnica de Impresión:** Serigrafía /  
Tampografía  
**Colores:** Blanco con Plata

Mouse inalámbrico. Incluye caja individual. No incluye baterías.

### HUB 01

HUB CUATRO PUERTOS

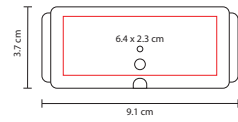

**Material:** Plástico  
**Medida:** 9.1 x 3.7 cm  
**Área de Impresión:** 6.4 x 2.3 cm  
**Técnica de Impresión:** Serigrafía  
**Colores:** Plata

HUB para 4 puertos USB. Incluye cable USB.

### HUB 02

HUB FOUR ENTRY

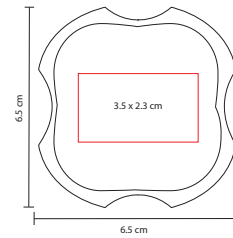

**Material:** Plástico  
**Medida:** 6.5 x 6.5 cm  
**Área de Impresión:** 3.5 x 2.3 cm  
**Técnica de Impresión:** Serigrafía  
**Colores:** Blanco

HUB para 4 puertos USB. Incluye ventosa.

### HUB 05

HUB BATIAN

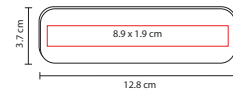

**Material:** Plástico  
**Medida:** 12.8 x 3.7 cm  
**Área de Impresión:** 8.9 x 1.9 cm  
**Técnica de Impresión:** Serigrafía  
**Colores:** Blanco

HUB para 4 puertos USB. Incluye cable USB.

### HUB 04

HUB CON DESPACHADOR DE NOTAS ANTARES

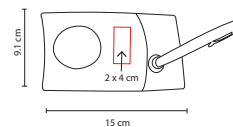

**Material:** Plástico  
**Medida:** 15 x 9.1 cm  
**Área de Impresión:** 2 x 4 cm  
**Técnica de Impresión:** Serigrafía  
**Colores:** Plata con Negro  
**Tinta:** Negra

HUB para 4 puertos USB. Incluye pluma, block de notas, porta clip y cable USB.



xoopar®

## HUB 06

HUB AQUA LITE

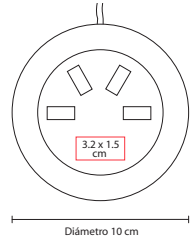

**Material:** Acrílico  
**Medida:** 10 cm Diámetro  
**Área de Impresión:** 3.2 x 1.5 cm  
**Técnica de Impresión:** Láser / Serigrafía  
**Colores:** Transparente

HUB de acrílico con luz. 4 Puertos USB versión 2.0. Incluye caja individual.



## LAP 004

FUNDA PARA LAPTOP  
JETSON

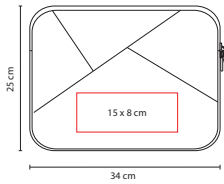

**Material:** Neopreno  
**Medida:** 34 x 25 cm  
**Área de Impresión:** 15 x 8 cm  
**Técnica de Impresión:** Serigrafía  
**Colores:** A/N/O/P/R/V

Porta laptop de 15".



## LAP 002

PORTA LAPTOP  
BAIKAL

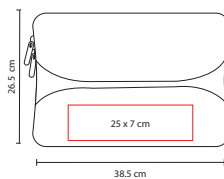

**Material:** Neopreno  
**Medida:** 38,5 x 26,5 cm  
**Área de Impresión:** 25 x 7 cm  
**Técnica de Impresión:** Serigrafía  
**Colores:** A/O/R/V/Y

Porta laptop de 15" con base antiderrapante.

LAP 003

MESA DE TRABAJO KOS

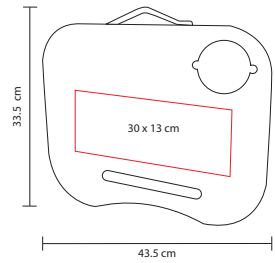

**Material:** MDF / Plástico / Tela  
**Medida:** 43.5 x 33.5 cm  
**Área de Impresión:** 30 x 13 cm  
**Técnica de Impresión:** Serigrafía  
**Colores:** Gris

Incluye porta vasos.

CD 100

COMPU-CLEAN

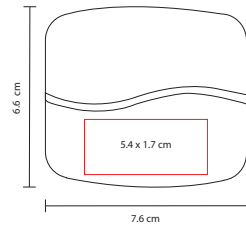
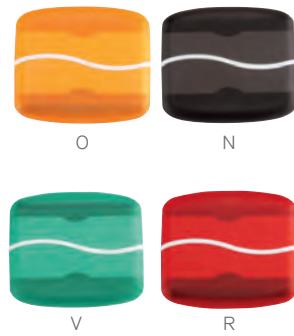

**Material:** Plástico  
**Medida:** 7.6 x 6.6 cm  
**Área de Impresión:** 5.4 x 1.7 cm  
**Técnica de Impresión:** Serigrafía  
**Colores:** A/N/O/R/V

Cepillo para teclado, franela para monitor.

CD 400

COMPU TECNO-CLEAN

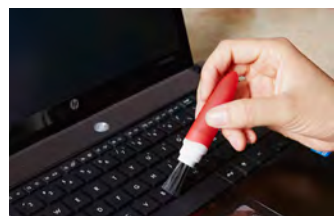

**Material:** Plástico  
**Medida:** 2.1 x 13 cm  
**Área de Impresión:** 1.3 x 3.6 cm  
**Técnica de Impresión:** Serigrafía  
**Colores:** A/N/R

Cepillo para teclado, franela para monitor.



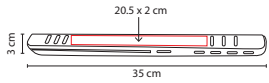

**Material:** Plástico  
**Medida:** 35 x 3 cm  
**Área de Impresión:** 20,5 x 2 cm  
**Técnica de Impresión:** Serigrafía  
**Colores:** Plata

Soporte que sirve como medio de enfriamiento para Laptop. Incluye HUB para 4 puertos.

## HUB 07

SOPORTE Y HUB  
MÓNACO

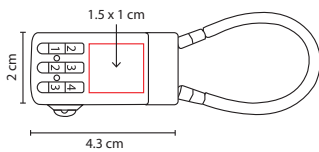
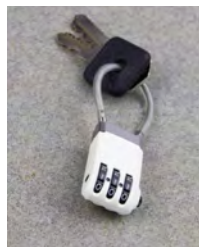
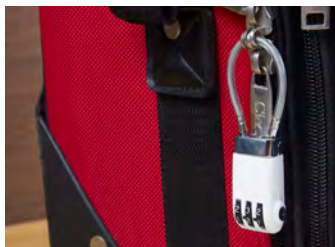

**Material:** Plástico  
**Medida:** 2 x 4.3 cm  
**Área de Impresión:** 1.5 x 1 cm  
**Técnica de Impresión:** Serigrafía  
**Colores:** Blanco

3 Funciones: Llavero, candado para USB para proteger información y candado para maleta. Combinación de 3 dígitos. No incluye USB.

## BLQ 001

CANDADO SARY

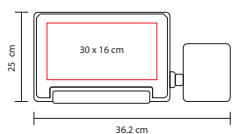

**Material:** Aluminio / Plástico  
**Medida:** 36.2 x 25 cm  
**Área de Impresión:** 30 x 16 cm  
**Técnica de Impresión:** Serigrafía  
**Colores:** Plata con Negro

Incluye porta vasos y porta lápices.

## LAP 001

MESA DE TRABAJO  
MANYARA



PRO 011

SCREEN CLEAN



A



R



B

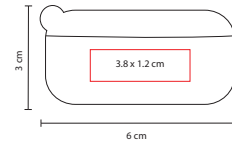

**Material:** Plástico  
**Medida:** 6 x 3 cm  
**Área de Impresión:** 3.8 x 1.2 cm  
**Técnica de Impresión:** Serigrafía  
**Colores:** A/B/R

Limpia pantallas con touch screen.

CEL 004

SOPORTE SNOW

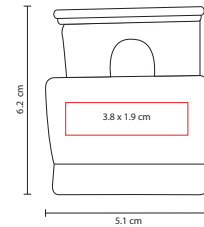

**Material:** Plástico  
**Medida:** 5.1 x 6.2 cm  
**Área de Impresión:** 3.8 x 1.9 cm  
**Técnica de Impresión:** Tampografía  
**Colores:** Blanco

Soporte para smartphone.

CEL 003

SUJETADOR RABAK

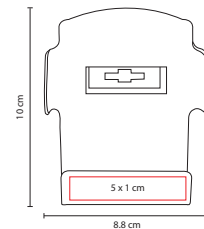

**Material:** Plástico  
**Medida:** 8.8 x 10 cm  
**Área de Impresión:** 5 x 1 cm  
**Técnica de Impresión:** Serigrafía  
**Colores:** Blanco

Sujetador de celular para automóvil. Incluye 2 pinzas para sostener.

CRG 002

CARGADOR USB PARA AUTOMÓVIL

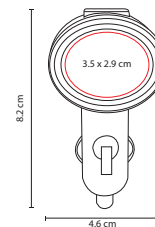

**Material:** Plástico  
**Medida:** 4.6 x 8.2 cm  
**Área de Impresión:** 3.5 x 2.9 cm  
**Técnica de Impresión:** Goteado en Resina  
**Colores:** Negro con Plata

Cargador para automóvil con entrada USB.



ACCESORIOS SMARTPHONE Y TABLET

CEL 007

SOPORTE BARI

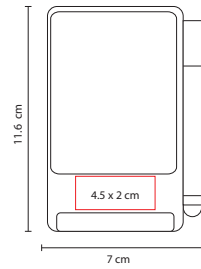

**Material:** Plástico  
**Medida:** 7 x 11.6 cm  
**Área de Impresión:** 4.5 x 2 cm  
**Técnica de Impresión:** Serigrafía  
**Colores:** Blanco con Gris  
**Tinta:** Negra

Soporte para smartphone con bolígrafo y touch screen.

TCH 004

TOUCH SCREEN  
BRUNEI

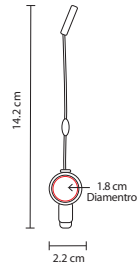

**Material:** Plástico  
**Medida:** 2.2 x 14.2 cm  
**Área de Impresión:** 1.8 cm Diámetro  
**Técnica de Impresión:** Goteado en Resina  
**Colores:** Plata

Touch screen con elástico y punta anti dust.

TCH 003

BOLÍGRAFO ESSAY

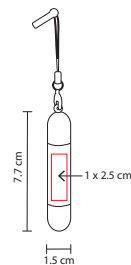

**Material:** Plástico  
**Medida:** 1.5 x 7.7 cm  
**Área de Impresión:** 1 x 2.5 cm  
**Técnica de Impresión:** Serigrafía  
**Colores:** Plata  
**Tinta:** Negra

Incluye punta anti dust y touch screen.

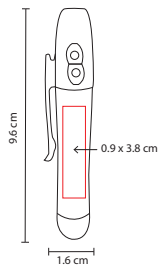

**Material:** Plástico  
**Medida:** 1.6 x 9.6 cm  
**Área de Impresión:** 0.9 x 3.8 cm  
**Técnica de Impresión:** Serigrafía  
**Colores:** Plata

Touch screen con lámpara y láser. Incluye batería.



Touch Screen

Láser

## TCH 002

APUNTADOR LITEN

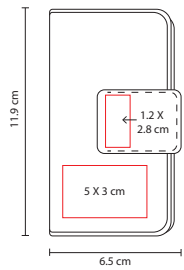

**Material:** Curpiel / Acero Inoxidable  
**Medida:** 6.5 x 11.9 cm  
**Área de Impresión:** 5 x 3 cm Curpiel / 1.2 x 2.8 cm Metal  
**Técnica de Impresión:** Serigrafía / Termograbado  
**Colores:** Negro

Exclusivo para smartphone. Pregunta a tu ejecutivo por la medida de smartphone compatible.



## CEL 005

FUNDA MACKENZIE

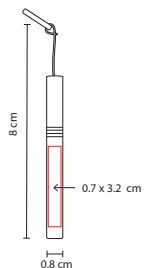

**Material:** Aluminio  
**Medida:** 0.8 x 8 cm  
**Área de Impresión:** 0.7 x 3.2 cm  
**Técnica de Impresión:** Láser / Serigrafía  
**Colores:** Plata

Touch screen con punta anti dust.



## TCH 001

TOUCH SCREEN  
LESOTHO



CEL 011

SOPORTE MAREBA



R



B

N

A

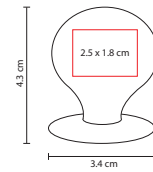
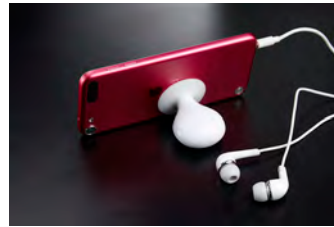

**Material:** Plástico  
**Medida:** 3.4 x 4.3 cm  
**Área de Impresión:** 2.5 x 1.8 cm  
**Técnica de Impresión:** Serigrafía / Tampografía  
**Colores:** A/B/N/R

Soporte con chupón para smartphone.

CEL 009

SOPORTE DALBY

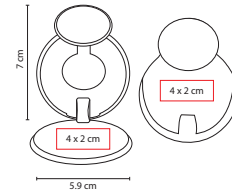
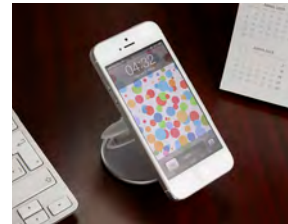

**Material:** Plástico  
**Medida:** 5.9 x 7 cm  
**Área de Impresión:** 4 x 2 cm  
**Técnica de Impresión:** Serigrafía  
**Colores:** Blanco con Plata

Soporte para smartphone con adherible y base de EVA.

CEL 006

SOPORTE BRESSOL



A



R

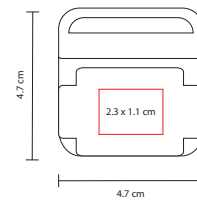

**Material:** Plástico  
**Medida:** 4.7 x 4.7 cm  
**Área de Impresión:** 2.3 x 1.1 cm  
**Técnica de Impresión:** Serigrafía  
**Colores:** A/R

Soporte para smartphone con limpia pantalla.

CEL 012

SOPORTE CAPEL

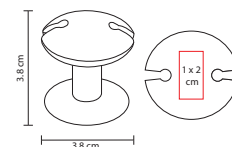

**Material:** Plástico  
**Medida:** 3.8 x 3.8 cm  
**Área de Impresión:** 1 x 2 cm  
**Técnica de Impresión:** Serigrafía / Tampografía  
**Colores:** Plata

Soporte para smartphone con chupón y porta audífonos.

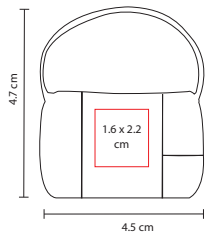

**Material:** Plástico  
**Medida:** 4.5 x 4.7 cm  
**Área de Impresión:** 1.6 x 2.2 cm  
**Técnica de Impresión:** Serigrafía  
**Colores:** Blanco



## CRG 001

CARGADOR TRANSFER



Cable cargador con entrada USB, 30 pin y micro USB.

**xoopar®**

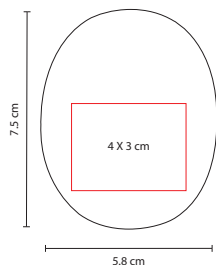

**Material:** Plástico / Silicón  
**Medida:** 5.8 x 7.5 cm  
**Área de Impresión:** 4 x 3 cm  
**Técnica de Impresión:** Serigrafía  
**Colores:** Blanco



## CRG 003

CARGADOR BEAM SPIDER



Batería recargable 1500 MgH de capacidad y adaptador multi entradas: Entrada USB, 30 pin, mini 5 pin, micro USB. Cargador con luz para indicar nivel de batería. Incluye caja individual.

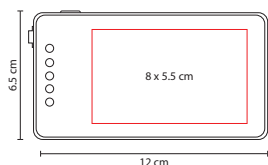

**Material:** Curpiel / Plástico  
**Medida:** 12 x 6.5 cm  
**Área de Impresión:** 8 x 5.5 cm  
**Técnica de Impresión:** Serigrafía  
**Colores:** Negro con Plata



## CRG 004

CARGADOR TRYDAN

Banco de poder para smartphone, capacidad 2600 Mah. Incluye LEDS indicadores de batería y cable USB.

TAB 001

FUNDA PARA TABLET JERSEY



A



R



S

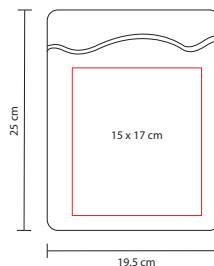

**Material:** Neopreno  
**Medida:** 19.5 x 25 cm  
**Área de Impresión:** 15 x 17 cm  
**Técnica de Impresión:** Serigrafía / Sublimación  
**Colores:** A/R/S

TAB 003

PORTA TABLET COARÍ

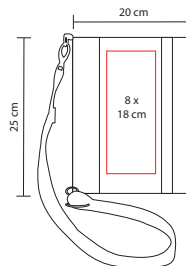

**Material:** Poliéster Exterior / Algodón Interior  
**Medida:** 20 x 25 cm  
**Área de Impresión:** 8 x 18 cm  
**Técnica de Impresión:** Serigrafía  
**Colores:** Negro con plata

Porta tablet con correa.

TAB 002

BASE PARA TABLET RIGER

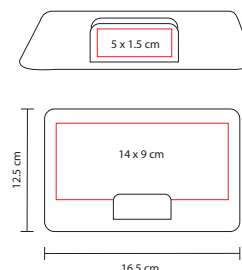

**Material:** Curpiel / Acero Inoxidable  
**Medida:** 16.5 x 12.5 cm  
**Área de Impresión:** 14 x 9 cm  
**Técnica de Impresión:** Serigrafía / Termograbado  
**Colores:** Negro



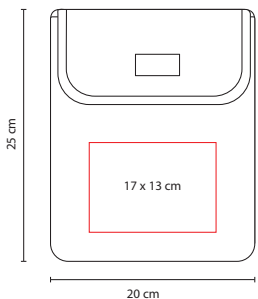

**Material:** Neopreno  
**Medida:** 20 x 25 cm  
**Área de Impresión:** 17 x 13 cm  
**Técnica de Impresión:** Serigrafía  
**Colores:** A/N/O/P/R/V

Funda para Tablet con broche velcro.

## TAB 004

FUNDA PARA TABLET  
COLETTE



P

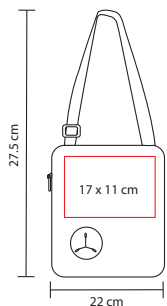

**Material:** Poliéster  
**Medida:** 22 x 27.5 cm  
**Área de Impresión:** 17 x 11 cm  
**Técnica de Impresión:** Bordado / Serigrafía  
**Colores:** Gris con naranja

Incluye bolsa trasera y aditamento especial para audífonos.

## SIN 125

PORTA TABLET CELTIC



Z 010

BOCINA LLAVERO DOVER

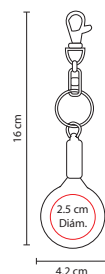

**Material:** Plástico  
**Medida:** 4.2 x 16 cm  
**Área de Impresión:** 2.5 cm Diámetro  
**Técnica de Impresión:** Goteado en Resina  
**Colores:** Blanco

Entrada auxiliar. No requiere baterías.

Z 100

BOCINA URBAN

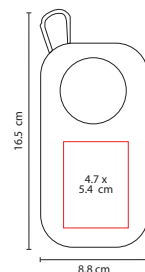

**Material:** Plástico  
**Medida:** 8.8 x 16.5 cm  
**Área de Impresión:** 4.7 x 5.4 cm  
**Técnica de Impresión:** Serigrafía  
**Colores:** Negro

Bocina para MP3 y MP4. Incluye cable auxiliar. Requiere baterías (3 pilas AAA), no incluidas.

Z 270

BOCINA CHALLENGER

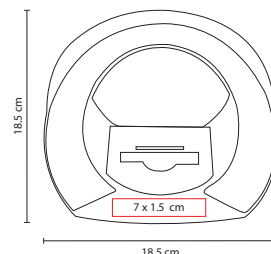

**Material:** Plástico  
**Medida:** 18.5 x 18.5 cm  
**Área de Impresión:** 7 x 1.5 cm  
**Técnica de Impresión:** Serigrafía  
**Colores:** B/N

Incluye adaptador de corriente, entrada de baterías (4 pilas AA, no incluidas), radio FM frecuencia 88MHZ-108MHZ. Entrada 30 pin y cable auxiliar para MP3 y MP4.



Z 420

BOCINA SOLO PLUS

xoopar®



**Material:** Acrílico  
**Medida:** 5 x 6 cm  
**Área de Impresión:** 3 x 1.7 cm  
**Técnica de Impresión:** Láser / Serigrafía  
**Colores:** Blanco

Bocina de acrílico con luz. Incluye cable auxiliar y entrada USB. Compatibilidad con MP3, MP4, PC, laptop y smartphone. Incluye funda de terciopelo y caja individual. Batería de litio recargable.

Z 230

BOCINA YAREN

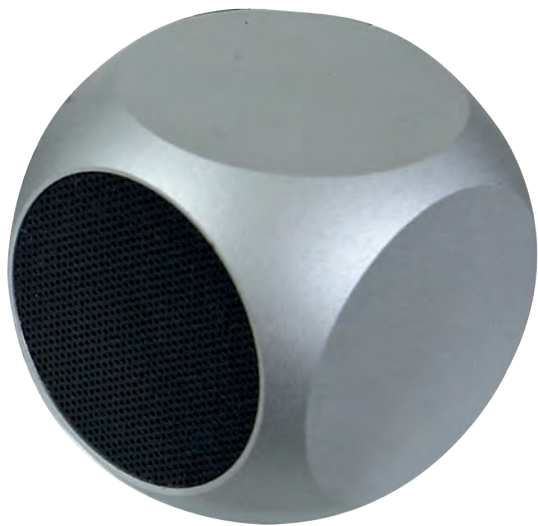

**Material:** Metal  
**Medida:** 3.8 x 3.8 cm  
**Área de Impresión:** 2 cm Diámetro  
**Técnica de Impresión:** Láser / Serigrafía  
**Colores:** Plata

Incluye cable auxiliar, cable USB, compatibilidad con laptop, smartphone y MP3. Incluye funda de terciopelo y caja individual.



## Z 110

### BOCINA INALÁMBRICA BERRY

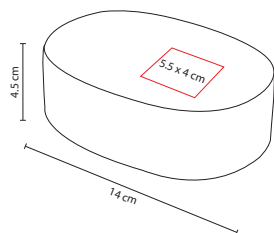

**Material:** Plástico  
**Medida:** 14 x 4,5 cm  
**Área de Impresión:** 5,5 x 4 cm  
**Técnica de Impresión:** Serigrafía / Tampografía  
**Colores:** Gris Oxford



Bocina inalámbrica, sistema NFA (Near Field Audio). Incluye cable USB y cable auxiliar. Batería de litio recargable.



## Z 200

### BOCINA TRENTO

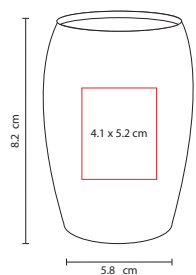

**Material:** Plástico  
**Medida:** 5,8 x 8,2 cm  
**Área de Impresión:** 4,1 x 5,2 cm  
**Técnica de Impresión:** Serigrafía  
**Colores:** Blanco



Incluye cable auxiliar, cable USB, instructivo y caja individual. Formato MP3 y WMA. Cuenta con lector de tarjeta formato SD. Batería recargable.

**xoopar®**

## Z 290

### BOCINA HORN

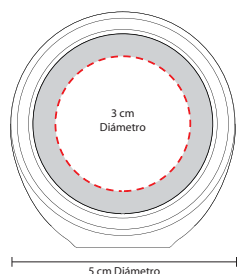

**Material:** Metal / Plástico  
**Medida:** 5 cm Diámetro  
**Área de Impresión:** 3 cm Diámetro  
**Técnica de Impresión:** Láser / Serigrafía  
**Colores:** Blanco



Bocinas con luz. Incluye cable auxiliar. Entrada USB con regulador de encendido, funda de terciopelo y caja individual.

Z 650

BOCINA HUB DEIRA

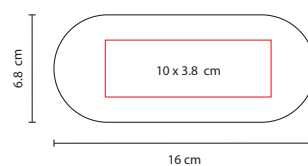

**Material:** Plástico  
**Medida:** 16 x 6.8 cm  
**Área de Impresión:** 10 x 3.8 cm  
**Técnica de Impresión:** Serigrafía  
**Colores:** Blanco

HUB para 3 puertos versión 2.0, carga smartphone y dispositivos de audio. Incluye cable auxiliar y cable USB.

Z 400

BOCINA JÓNICA

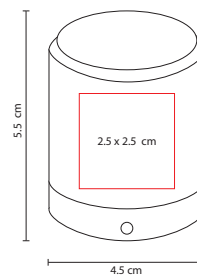

**Material:** Aluminio / Plástico  
**Medida:** 4.5 x 5.5 cm  
**Área de Impresión:** 2.5 x 2.5 cm  
**Técnica de Impresión:** Pantógrafo / Tampografía  
**Colores:** Plata con Negro

Incluye bolsa de terciopelo, cable auxiliar a auxiliar, cable USB. No requiere baterías, se carga al conectarse a la computadora.

## MP3 010

MP3 SARAJEVO

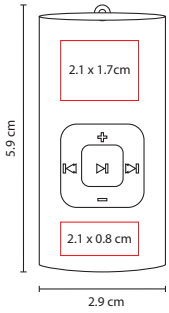

**Material:** Plástico  
**Medida:** 2.9 x 5.9 cm  
**Área de Impresión:** 2.1 x 1.7 cm  
**Técnica de Impresión:** Serigrafía  
**Colores:** Plata  
**Capacidad:** 2 GB

Incluye audífonos, cable con conexión entrada USB y estuche.

## MP3 020

REPRODUCTOR MP3  
COLOR SOUND

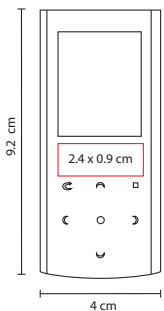

**Material:** Plástico  
**Medida:** 4 x 9.2 cm  
**Área de Impresión:** 2.4 x 0.9 cm  
**Técnica de Impresión:** Serigrafía  
**Colores:** Negro con Plata  
**Capacidad:** 2 GB

Pantalla digital. Controles touch. Incluye cable USB, audífonos, software de instalación y estuche

AUD 004

AUDÍFONOS MELODY

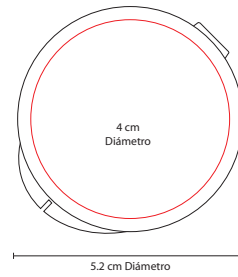

**Material:** Plástico  
**Medida:** 5.2 cm Diámetro  
**Área de Impresión:** 4 cm Diámetro  
**Técnica de Impresión:** Serigrafía  
**Colores:** A/R

Incluye estuche redondo para audífonos.



A



R



AUD 002

DIVISOR DE  
AUDÍFONOS TORIL

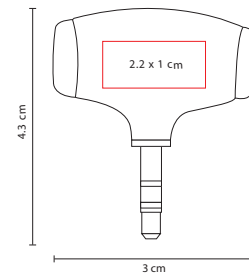

**Material:** Plástico  
**Medida:** 3 x 4.3 cm  
**Área de Impresión:** 2.2 x 1 cm  
**Técnica de Impresión:** Serigrafía  
**Colores:** Blanco

Dispositivo con 2 entradas auxiliares para compartir el mismo audio.



CEL 008

BOCINA JAZZ

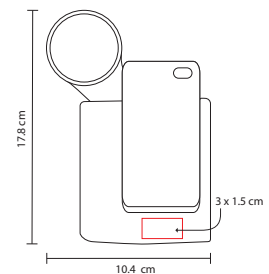

**Material:** Plástico  
**Medida:** 10.4 x 17.8 cm  
**Área de Impresión:** 3 x 1.5 cm  
**Técnica de Impresión:** Serigrafía  
**Colores:** B/N

Amplificador de sonido exclusivo para smartphone. Pregunta a tu ejecutivo por la medida compatible.



B



N







## AUD 003

AUDÍFONOS ENJOY

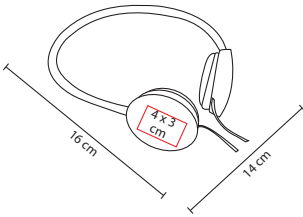

**Material:** Plástico  
**Medida:** 14 x 16 cm  
**Área de Impresión:** 4 x 3 cm  
**Técnica de Impresión:** Serigrafía / Tampografía  
**Colores:** Blanco con Plata

Audífonos acojinados con cable entrada auxiliar.



## AUD 001

AUDÍFONOS MEGA BEAT

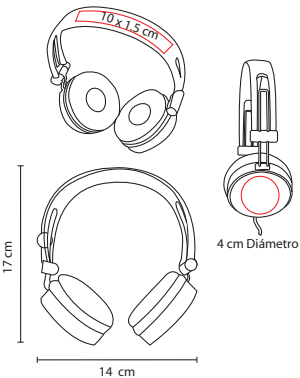

**Material:** Metal / Plástico  
**Medida:** 14 x 17 cm  
**Área de Impresión:** 4 cm Diámetro  
**Técnica de Impresión:** Serigrafía  
**Colores:** Blanco

Audífonos acojinados con cable entrada auxiliar. Incluye funda individual de satén negra.

### USB 004

USB ZURICH

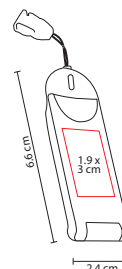
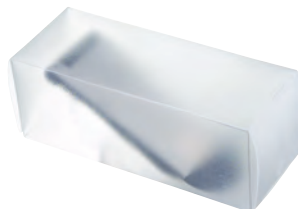

**Material:** Metal / PVC  
**Medida:** 2,4 x 6,6 cm  
**Área de Impresión:** 1,9 x 3 cm  
**Técnica de Impresión:** Pantógrafo / Serigrafía  
**Colores:** Plata con Negro  
**Capacidad:** 2 GB

USB con cordón de 46cm. Incluye caja individual.

### USB 002

USB PICASSO



R



A

Y

S



**Material:** Plástico  
**Medida:** 7,2 x 3,2 cm  
**Área de Impresión:** 5,5 x 1,5 cm  
**Técnica de Impresión:** Serigrafía  
**Colores:** A/R/S/Y  
**Capacidad:** 2 GB

USB con cordón de 46cm. Incluye caja individual.

### USB 012

USB OMI



A



B

R

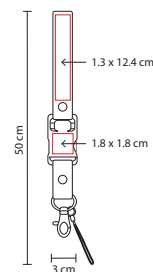
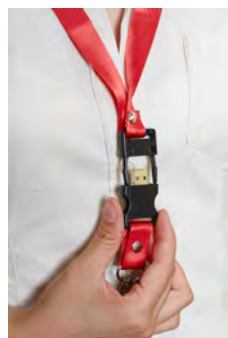

**Material:** Plástico / Tela  
**Medida:** 3 x 50 cm  
**Área de Impresión:** 1,8 x 1,8 cm  
**Técnica de Impresión:** Serigrafía  
**Colores:** A/B/R  
**Capacidad:** 2 GB

Incluye colgante para celular y caja individual.



USB

## USB 100

USB REGENCY

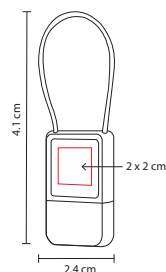
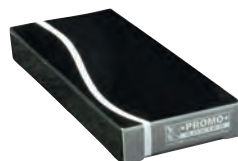

**Material:** Metal  
**Medida:** 2.4 x 4.1 cm  
**Área de Impresión:** 2 x 2 cm  
**Técnica de Impresión:** Goteado en Resina / Grabado Espejo  
**Colores:** Níquel  
**Capacidad:** 2 GB

Incluye caja individual.

## USB 007

USB STING

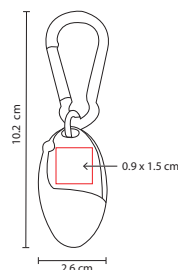

**Material:** Metal  
**Medida:** 2.6 x 10.2 cm  
**Área de Impresión:** 0.9 x 1.5 cm  
**Técnica de Impresión:** Láser / Pantógrafo  
**Colores:** Plata con Negro  
**Capacidad:** 2 GB

Incluye estuche y carabina.

## USB 014

USB KOBE

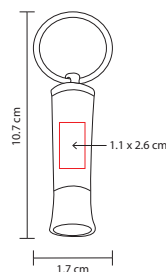

**Material:** Metal / Plástico  
**Medida:** 1.7 x 10.7 cm  
**Área de Impresión:** 1.1 x 2.6 cm  
**Técnica de Impresión:** Serigrafía  
**Colores:** Blanco  
**Capacidad:** 2 GB

LLavero USB. Enciende LED al conectar. Incluye caja individual metálica.

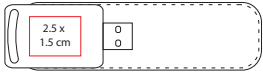
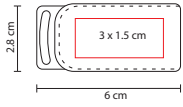

## USB 020

USB MILETO

**Material:** Curpiel / Metal  
**Medida:** 6 x 2,8 cm  
**Área de Impresión:** 3 x 1,5 cm  
**Técnica de Impresión:** Láser / Pantógrafo / Serigrafía / Termograbado  
**Colores:** Negro  
**Capacidad:** 8 GB

Incluye caja individual.

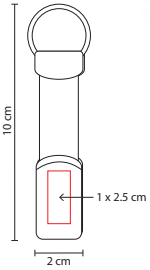

## USB 021

USB LLAVERO MARION

**Material:** Hule / Metal  
**Medida:** 2 x 10 cm  
**Área de Impresión:** 1 x 2,5 cm  
**Técnica de Impresión:** Láser / Serigrafía  
**Colores:** Negro  
**Capacidad:** 4 GB

Incluye caja individual.

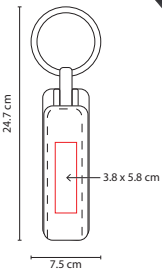

## USB 009

USB BYTE

**Material:** Curpiel / Metal  
**Medida:** 7,5 x 24,7 cm  
**Área de Impresión:** 3,8 x 5,8 cm  
**Técnica de Impresión:** Láser / Pantógrafo / Serigrafía / Termograbado  
**Colores:** Negro  
**Capacidad:** 4 GB

Incluye caja individual.



**USB 006**

USB BLACK CRUISE

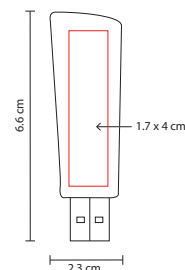

**Material:** Plástico  
**Medida:** 2.3 x 6.6 cm  
**Área de Impresión:** 1.7 x 4 cm  
**Técnica de Impresión:** Serigrafía  
**Colores:** Plata con Negro  
**Capacidad:** 2 GB

USB con clip. Incluye caja individual.

**USB 110**

USB SAPORO

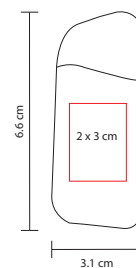

**Material:** Plástico  
**Medida:** 3.1 x 6.6 cm  
**Área de Impresión:** 2 x 3 cm  
**Técnica de Impresión:** Serigrafía  
**Colores:** A/R/T  
**Capacidad:** 2 GB

Se enciende LED de color al conectar. Incluye caja individual.

A

R

T

**USB 008**

USB ASTRYD

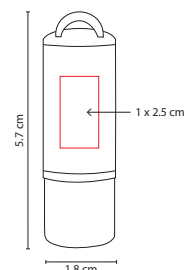

**Material:** Plástico  
**Medida:** 1.8 x 5.7 cm  
**Área de Impresión:** 1 x 2.5 cm  
**Técnica de Impresión:** Serigrafía  
**Colores:** N/S  
**Capacidad:** 2 GB

Incluye caja individual.

N2

S2

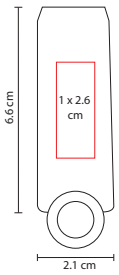

**Material:** Plástico  
**Medida:** 2.1 x 6.6 cm  
**Área de Impresión:** 1 x 2.6 cm  
**Técnica de Impresión:** Serigrafía  
**Colores:** A/O/R/V  
**Capacidad:** 4 GB

Tapa translúcida. Incluye caja individual.

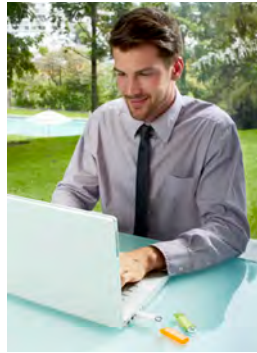

## USB 024

USB ELIE



V A R



O

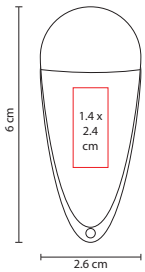

**Material:** Plástico  
**Medida:** 2.6 x 6 cm  
**Área de Impresión:** 1.4 x 2.4 cm  
**Técnica de Impresión:** Serigrafía /  
 Tampografía  
**Colores:** B/N  
**Capacidad:** 4 GB

Incluye caja individual.



## USB 023

USB KANDOS



B



N

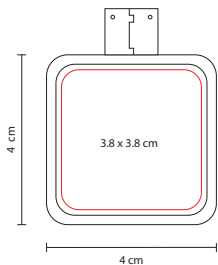

**Material:** Plástico  
**Medida:** 4 x 4 cm  
**Área de Impresión:** 3.8 x 3.8 cm  
**Técnica de Impresión:** Goteado en Resina /  
 Serigrafía  
**Colores:** Blanco  
**Capacidad:** 4 GB

USB giratoria. Incluye caja individual.

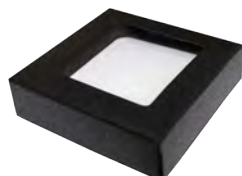

## USB 016

USB BETA



### USB 013

#### USB ARGOS



S



A



R

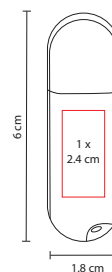

**Material:** Plástico  
**Medida:** 1.8 x 6 cm  
**Área de Impresión:** 1 x 2.4 cm  
**Técnica de Impresión:** Serigrafía  
**Colores:** A/R/S  
**Capacidad:** 4 GB

Tapa transparente. Incluye caja individual.

### USB 120

#### USB STORAGE



N



B



S

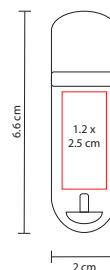
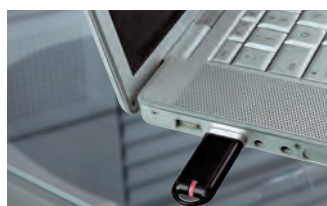

**Material:** Plástico  
**Medida:** 2 x 6.6 cm  
**Área de Impresión:** 1.2 x 2.5 cm  
**Técnica de Impresión:** Serigrafía  
**Colores:** B/N/S  
**Capacidad:** 8 GB

Se enciende LED de color al conectar. Incluye caja individual.

### USB 011

#### USB POLARIS



R



B



A

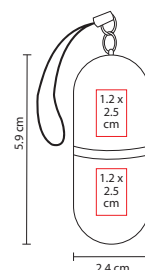

**Material:** Plástico  
**Medida:** 2.4 x 5.9 cm  
**Área de Impresión:** 1.2 x 2.5 cm  
**Técnica de Impresión:** Serigrafía  
**Colores:** A/B/R  
**Capacidad:** 4 GB

USB con colgante para celular. Incluye caja individual.



## USB 015

USB FLOPPY

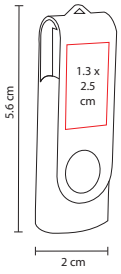

N



R



A

**Material:** Metal / Rubber

**Medida:** 2 x 5,6 cm

**Área de Impresión:** 1,3 x 2,5 cm

**Técnica de Impresión:** Láser / Pantógrafo / Serigrafía

**Colores:** A/N/R

**Capacidad:** 4 GB

USB giratoria. Incluye caja individual.

## USB 017

USB PIXEL

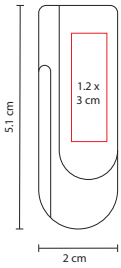

R



A



V



O

**Material:** Aluminio / Plástico

**Medida:** 2 x 5,1 cm

**Área de Impresión:** 1,2 x 3 cm

**Técnica de Impresión:** Láser / Serigrafía

**Colores:** A/O/R/V

**Capacidad:** 4 GB

Incluye caja individual.

xoopar®

## USB 018

USB AQUA TAIL

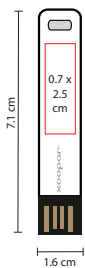

A



V



O



**Material:** Acrílico

**Medida:** 1,6 x 7,1 cm

**Área de Impresión:** 0,7 x 2,5 cm

**Técnica de Impresión:** Láser / Serigrafía

**Colores:** A/O/V

**Capacidad:** 2 GB

USB de acrílico con luz. Incluye estuche individual.

MK 010

RELOJ ARTEK

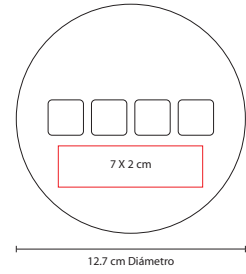

**Material:** Metal / Plástico  
**Medida:** 12.7 cm Diámetro  
**Área de Impresión:** 7 x 2 cm  
**Técnica de Impresión:** Láser / Pantógrafo  
**Colores:** Plata

Funciones: Reloj, alarma, calendario y termómetro. Incluye batería.

M 80407

RELOJ VIENA

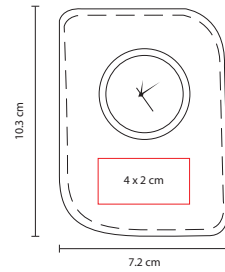

**Material:** Curpiel / Metal  
**Medida:** 7.2 x 10.3 cm  
**Área de Impresión:** 4 x 2 cm  
**Técnica de Impresión:** Láser / Serigrafía  
**Colores:** Negro

Reloj con estuche. Incluye batería.

M 80307

RELOJ IRLANDA

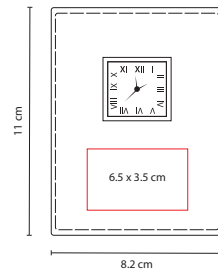

**Material:** Curpiel / Metal  
**Medida:** 8.2 x 11 cm  
**Área de Impresión:** 6.5 x 3.5 cm  
**Técnica de Impresión:** Láser / Serigrafía  
**Colores:** Café

Reloj con estuche. Incluye batería.



MK 400

RELOJ LONDON

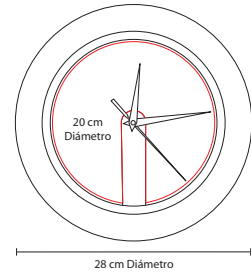

**Material:** Plástico  
**Medida:** 28 cm Diámetro  
**Área de Impresión:** 20 cm Diámetro  
**Técnica de Impresión:** Serigrafía  
**Colores:** Plata

Amplia área de impresión. Venta de kit listo para armar e imprimir. No incluye baterías.

MK 600

RELOJ MUNICH

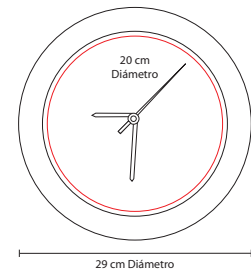

**Material:** Plástico  
**Medida:** 29 cm Diámetro  
**Área de Impresión:** 20 cm Diámetro  
**Técnica de Impresión:** Serigrafía  
**Colores:** Translúcido

Amplia área de impresión. Venta de kit listo para armar e imprimir. No incluye baterías.

MK 2000

RELOJ TORNADO

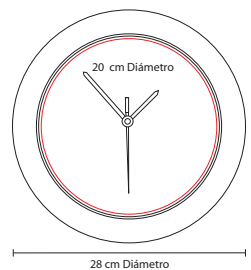

**Material:** Plástico  
**Medida:** 28 cm Diámetro  
**Área de Impresión:** 20 cm Diámetro  
**Técnica de Impresión:** Serigrafía  
**Colores:** A/B/N/R

Amplia área de impresión. Venta de kit listo para armar e imprimir. No incluye baterías.



## GLF 01

RELOJ Y  
PORTAPLUMAS GOLF

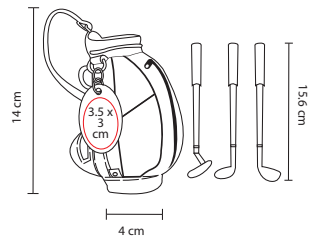

**Material:** Curpiel / Metal  
**Medida:** 4 x 14 cm  
**Área de Impresión:** 3,5 x 3 cm  
**Técnica de Impresión:** Pantógrafo / Serigrafía  
**Colores:** Blanco con Negro

Incluye bolígrafos en forma de palos de golf, tinta negra, roja y azul, placa metálica para impresión. Incluye baterías.



6:00

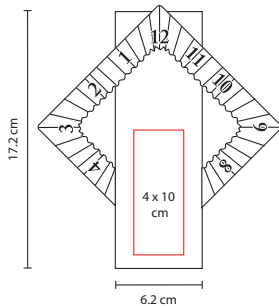

## MK 090

RELOJ TORRE BELEM

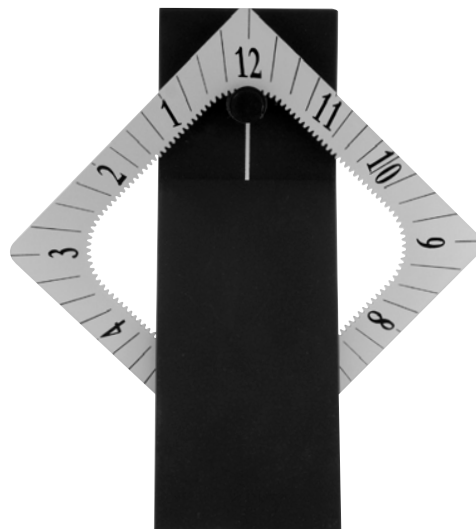

12:00



6:00

**Material:** Plástico  
**Medida:** 6.2 x 17.2 cm  
**Área de Impresión:** 4 x 10 cm  
**Técnica de Impresión:** Serigrafía  
**Colores:** Negro con Plata

Incluye doble carátula, números romanos y arábigos. Batería (1 pila AA) no incluida.

MK 3000

RELOJ TOUCH LIGHT

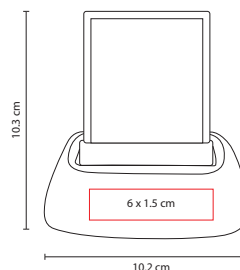

**Materia:** Plástico  
**Medida:** 10.2 x 10.3 cm  
**Área de Impresión:** 6 x 1.5 cm  
**Técnica de Impresión:** Serigrafía / Tampografía  
**Colores:** Blanco

Funciones: Alarma, calendario, cronómetro y termómetro. Al presionarlo cambia de color y función. Baterías (3 pilas AAA) no incluidas.

MK 700

RELOJ LAMP CLOCK

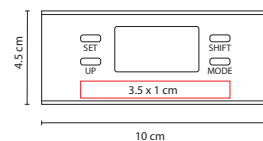

**Materia:** Plástico  
**Medida:** 10 x 4.5 cm  
**Área de Impresión:** 3.5 x 1 cm  
**Técnica de Impresión:** Serigrafía  
**Colores:** Plata

Reloj triangular de LCD con cronómetro, despertador y lámpara. No incluye baterías.

MK 100

RELOJ PIRAMIDE NIZA



6:00



11:15



11:15

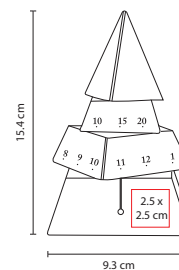

**Materia:** Plástico  
**Medida:** 9.3 x 15.4 cm  
**Área de Impresión:** 2.5 x 2.5 cm  
**Técnica de Impresión:** Serigrafía  
**Colores:** Plata

Reloj con hora y minutos giratorios. Batería (1 pila AA) no incluida.

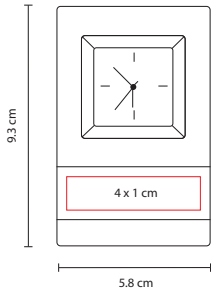
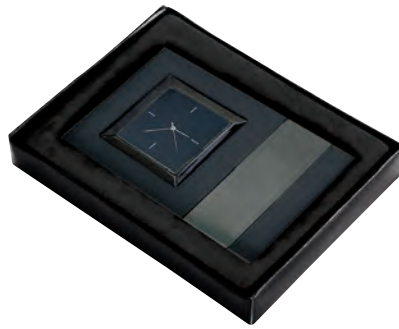

**Material:** Metal  
**Medida:** 5.8 x 9.3 cm  
**Área de Impresión:** 4 x 1 cm  
**Técnica de Impresión:** Láser  
**Colores:** Negro

Reloj con estuche. Incluye baterías.

## MK 080

RELOJ EGE0

## MK 250

RELOJ VON NEWMAN

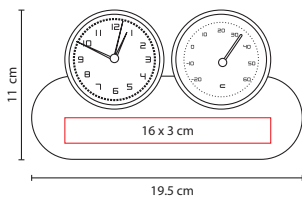

**Material:** Aluminio / Plástico Imitación Madera  
**Medida:** 19.5 x 11 cm  
**Área de Impresión:** 16 x 3 cm  
**Técnica de Impresión:** Serigrafía  
**Colores:** Madera

Funciones: Reloj, alarma y termómetro. Incluye batería (1 pila AA).

### CT 110

MINI CALCULADORA COLGABLE

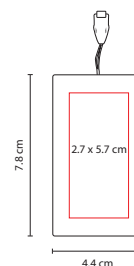

**Material:** Plástico  
**Medida:** 4.4 x 7.8 cm  
**Área de Impresión:** 2.7 x 5.7 cm  
**Técnica de Impresión:** Serigrafía  
**Colores:** Blanco

Calculadora de 8 dígitos. Incluye cordón y batería.

### CT 150

CALCULADORA COLGABLE ENCORE



A



R



N

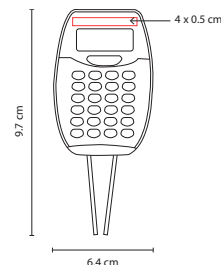
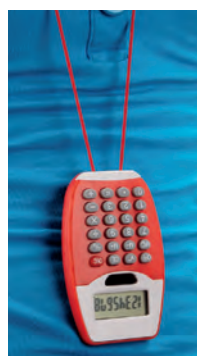

**Material:** Plástico  
**Medida:** 6.4 x 9.7 cm  
**Área de Impresión:** 4 x 0.5 cm  
**Técnica de Impresión:** Tampografía  
**Colores:** A/N/R

Calculadora de 8 dígitos. Incluye cordón de 48 cm. Batería solar.

### CT 304

CALCULADORA EXPO

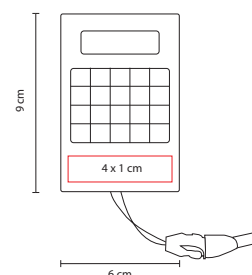

**Material:** Plástico  
**Medida:** 6 x 9 cm  
**Área de Impresión:** 4 x 1 cm  
**Técnica de Impresión:** Serigrafía  
**Colores:** Plata

Calculadora de 8 dígitos. Incluye porta tarjetas, cordón y batería.







**CT 601**  
CALCULADORA CLIP

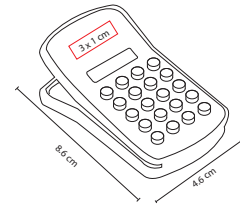

**Material:** Plástico  
**Medida:** 4.6 x 8.6 cm  
**Área de Impresión:** 3 x 1 cm  
**Técnica de Impresión:** Serigrafía / Tampografía  
**Colores:** Blanco Translúcido

Calculadora con clip. 8 Dígitos. Incluye batería.

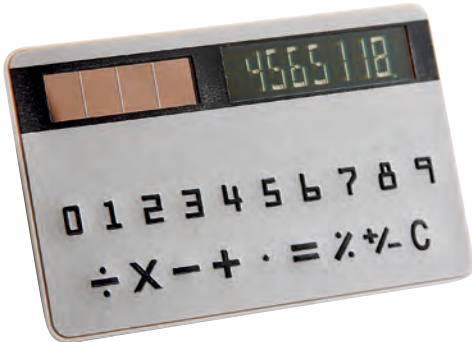

**CT 619**  
MINI CALCULADORA CREDIT CARD

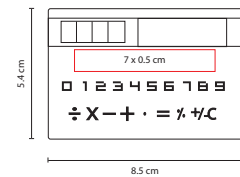

**Material:** Plástico  
**Medida:** 8.5 x 5.4 cm  
**Área de Impresión:** 7 x 0.5 cm  
**Técnica de Impresión:** Serigrafía  
**Colores:** Gris

Calculadora 8 dígitos. Batería solar.



**CT 1630**  
CALCULADORA WALLET

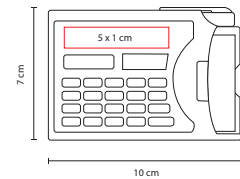

**Material:** Plástico  
**Medida:** 10 x 7 cm  
**Área de Impresión:** 5 x 1 cm  
**Técnica de Impresión:** Serigrafía  
**Colores:** Plata con Negro

Calculadora de 8 dígitos. Incluye tarjetero y bolígrafo. Batería solar.



**CT 500**  
CALCULADORA INVISIBLE

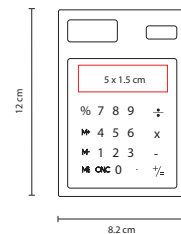

**Material:** Plástico  
**Medida:** 8.2 x 12 cm  
**Área de Impresión:** 5 x 1.5 cm  
**Técnica de Impresión:** Serigrafía  
**Colores:** A/N/R/V

Calculadora 8 dígitos. Tablero transparente. Batería solar.

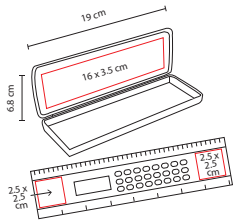

**Material:** Plástico  
**Medida:** 19 x 6.8 cm  
**Área de Impresión:** 16 x 3.5 cm Estuche / 2.5 x 2.5 cm Regla  
**Técnica de Impresión:** Serigrafía  
**Colores:** Blanco con Gris

Estuche con regla y calculadora de 8 dígitos. Incluye batería. Bolígrafos no incluidos.

## CT 610

CALCULADORA REGLA  
 IZEL

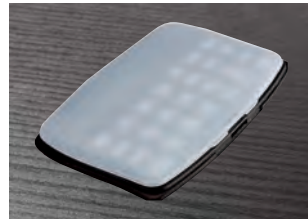
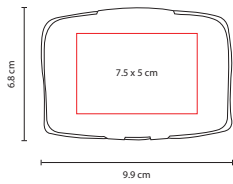
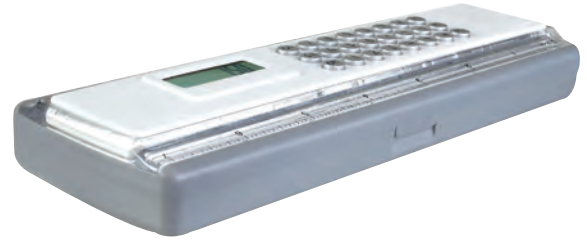

**Material:** Plástico  
**Medida:** 9.9 x 6.8 cm  
**Área de Impresión:** 7.5 x 5 cm  
**Técnica de Impresión:** Serigrafía  
**Colores:** Negro con Blanco

Calculadora con tapa. 10 Dígitos. Incluye batería.

## CT 005

CALCULADORA BLACK  
 & WHITE

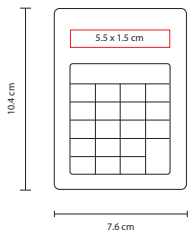

N

A



R

**Material:** Plástico  
**Medida:** 7.6 x 10.4 cm  
**Área de Impresión:** 5.5 x 1.5 cm  
**Técnica de Impresión:** Serigrafía  
**Colores:** A/N/R

Calculadora 8 dígitos. Pantalla deslizable. Incluye batería.

## CT 350

CALCULADORA  
 LAGRANGE

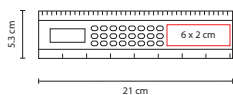

R



B

**Material:** Plástico  
**Medida:** 21 x 5.3 cm  
**Área de Impresión:** 6 x 2 cm  
**Técnica de Impresión:** Serigrafía  
**Colores:** A/B/R

Calculadora con regla de 20 cm. 8 Dígitos. Incluye batería.

## CT 604

CALCULADORA REGLA



A

KA 82593-11

SET DE ESCRITORIO  
MAJESTY

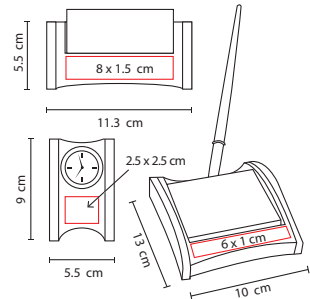

**Material:** Metal / Terminados Imitación Madera  
**Técnica de Impresión:** Serigrafía  
**Colores:** Tinto

Incluye porta notas (100 hojas) con bolígrafo, reloj, tarjetero y caja de regalo.

70700

SET DE ESCRITORIO  
KING

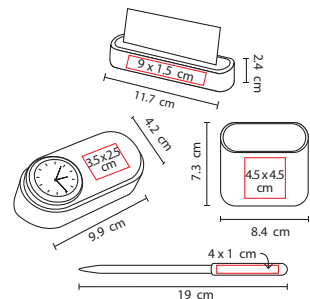

**Material:** Curpiel / Metal  
**Técnica de Impresión:** Láser / Serigrafía  
**Colores:** Plata con Negro

Incluye porta plumas, abrecartas, reloj, tarjetero y caja de regalo. Bolígrafos no incluidos.



OFICINA

92976

SET DE ESCRITORIO JACKSON

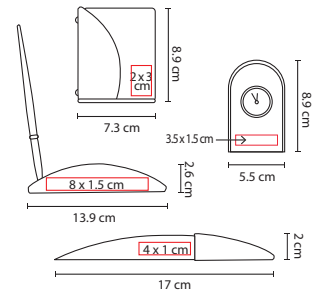

**Material:** Curpiel / Metal Esmaltado  
**Técnica de Impresión:** Láser / Serigrafía  
**Colores:** Negro

Incluye tarjetero con bolígrafo, porta plumas, abrecartas, reloj y caja de regalo.

60800

SET DE ESCRITORIO MONARCA

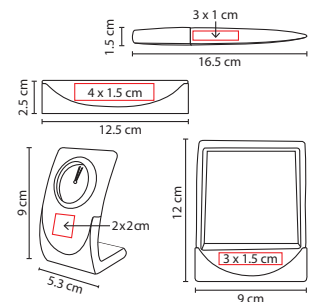
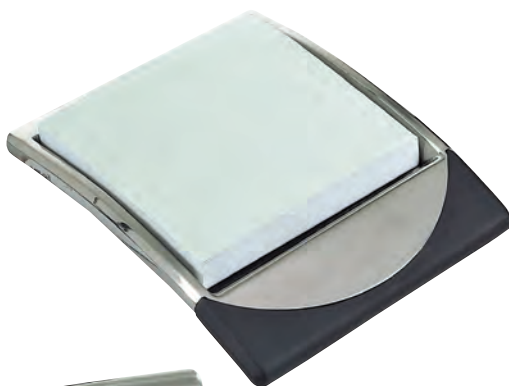

**Material:** Hule / Metal  
**Técnica de Impresión:** Láser / Serigrafía  
**Colores:** Negro con Plata

Incluye reloj, porta notas (100 hojas), abrecartas, tarjetero y caja de regalo.

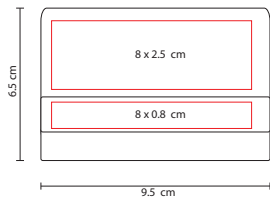

**Material:** Curpiel / Metal  
**Medida:** 9.5 x 6.5 cm  
**Área de Impresión:** 8 x 2.5 cm Curpiel /  
 8 x 0.8 cm Metal  
**Técnica de Impresión:** Láser / Serigrafía /  
 Termograbado  
**Colores:** Café

Tarjetero horizontal. Doble compartimento.



M 83450

TARJETERO HAUT

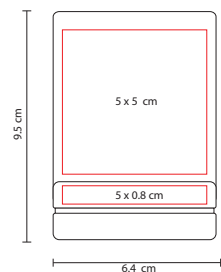

**Material:** Curpiel / Metal  
**Medida:** 6.4 x 9.5 cm  
**Área de Impresión:** 5 x 5 cm Curpiel /  
 5 x 0.8 cm Metal  
**Técnica de Impresión:** Láser / Serigrafía /  
 Termograbado  
**Colores:** Negro

Tarjetero vertical. Doble compartimento.



M 83400

TARJETERO KOZE

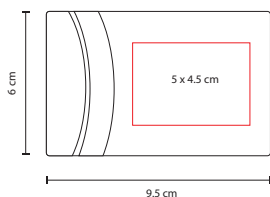

**Material:** Aluminio / Imitación Madera  
**Medida:** 9.5 x 6 cm  
**Área de Impresión:** 5 x 4.5 cm  
**Técnica de Impresión:** Pantógrafo / Serigrafía  
**Colores:** Plata

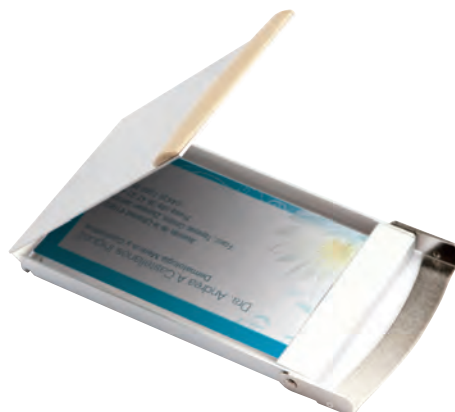

M 83945-11

TARJETERO DE  
 ALUMINIO TIMBER



M 83964

TARJETERO DE ALUMINIO VEKONY

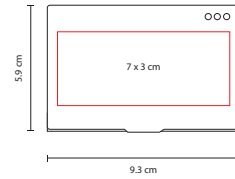

**Material:** Aluminio  
**Medida:** 9.3 x 5.9 cm  
**Área de Impresión:** 7 x 3 cm  
**Técnica de Impresión:** Pantógrafo / Serigrafía  
**Colores:** Plata

M 86114-5

TARJETERO DE ALUMINIO PRAZA

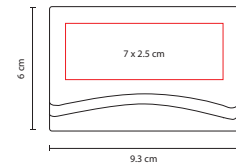

**Material:** Aluminio  
**Medida:** 9.3 x 6 cm  
**Área de Impresión:** 7 x 2.5 cm  
**Técnica de Impresión:** Pantógrafo / Serigrafía  
**Colores:** Plata

M 83200

TARJETERO ASPEN

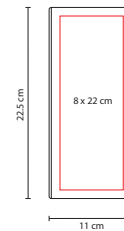

**Material:** Plástico  
**Medida:** 11 x 22.5 cm  
**Área de Impresión:** 8 x 22 cm  
**Técnica de Impresión:** Serigrafía  
**Colores:** Negro

Para 96 tarjetas.

PRO 519

MINI KIT DE ESCRITORIO

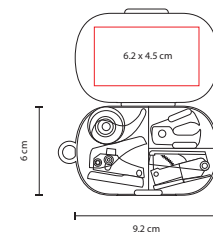

**Material:** Metal / Plástico  
**Medida:** 9.2 x 6 cm  
**Área de Impresión:** 6.2 x 4.5 cm  
**Técnica de Impresión:** Serigrafía  
**Colores:** Transparente

Contiene: Engrapadora, perforadora, despachador de cinta y quita grapas.



62300

SET ANTARTIC

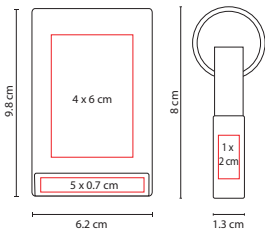

**Material:** Curpiel / Metal  
**Técnica de Impresión:** Láser / Serigrafía / Termograbado  
**Colores:** Blanco

Incluye llavero, tarjetero y estuche.

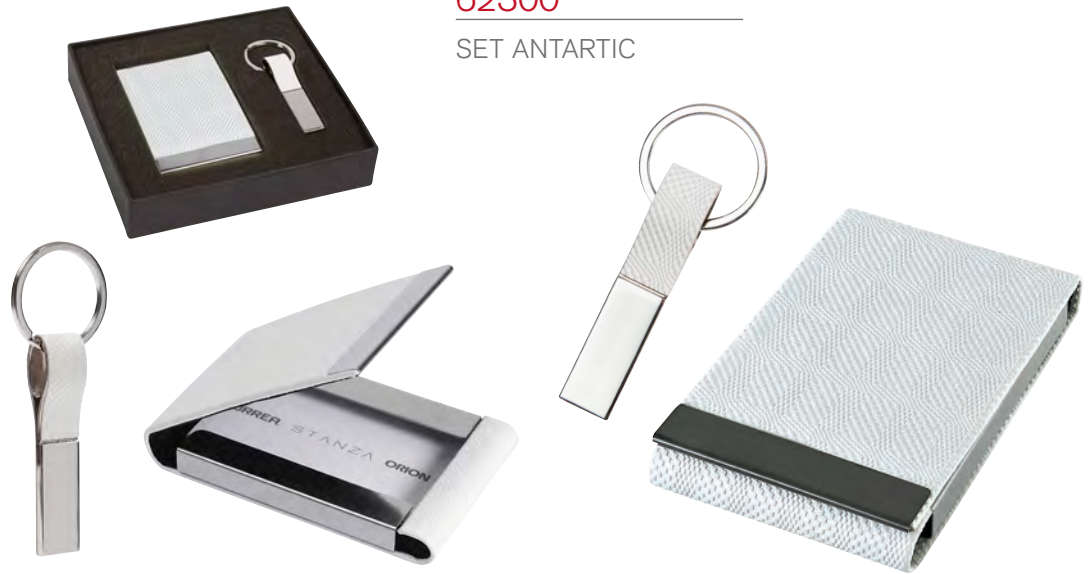

60100

SET DUKE

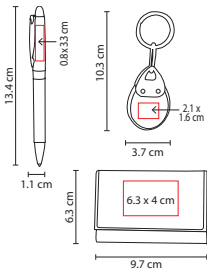

**Material:** Curpiel / Metal  
**Técnica de Impresión:** Láser / Serigrafía / Termograbado  
**Colores:** Chocolate  
**Tinta:** Negra

Incluye llavero, tarjetero, bolígrafo y estuche.



61200

SET PRINCE

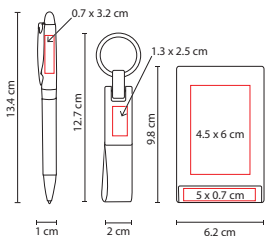

**Material:** Curpiel / Metal  
**Técnica de Impresión:** Láser / Serigrafía / Termograbado  
**Colores:** Negro  
**Tinta:** Negra

Incluye llavero, tarjetero, bolígrafo y estuche.



## KTC 011

REVISTERO GOSSIP



**Material:** Curpiel  
**Medida:** 36 x 34.5 cm  
**Área de Impresión:** 12 x 12 cm  
**Técnica de Impresión:** Láser / Serigrafía  
**Colores:** C/R

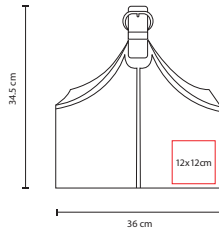

## CT 090

CALCULADORA CON PORTA NOTAS



**Material:** Plástico  
**Medida:** 13 x 10.5 cm  
**Área de Impresión:** 3 x 3 cm  
**Técnica de Impresión:** Serigrafía  
**Colores:** Negro

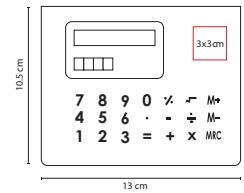

Calculadora 8 dígitos. Incluye notas adhesivas y calendario 2014-2015. Batería solar.

## HL 6520

PORTA NOTAS BOX NOTES



**Material:** Plástico  
**Medida:** 9 x 9.4 cm  
**Área de Impresión:** 5 x 5 cm  
**Técnica de Impresión:** Serigrafía  
**Colores:** Negro

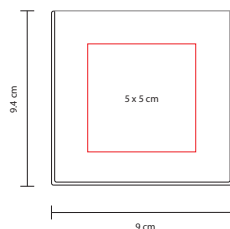

Incluye 200 hojas de notas y calendario 2014-2015.

## HL 6655

ESTUCHE CON PORTA NOTAS - CALENDARIO



**Material:** Plástico  
**Medida:** 14.8 x 8.7 cm  
**Área de Impresión:** 11 x 6 cm  
**Técnica de Impresión:** Serigrafía  
**Colores:** Negro

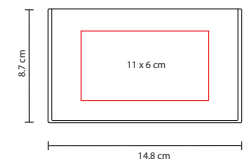

Incluye notas adhesivas y calendario 2014-2015.

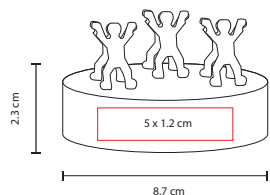

**Material:** Plástico  
**Medida:** 8.7 x 2.3 cm  
**Área de Impresión:** 5 x 1.2 cm  
**Técnica de Impresión:** Serigrafía  
**Colores:** Blanco

Incluye 8 clips.



## PRO 055

PORTA CLIPS IMANTADO  
ANTI-STRESS

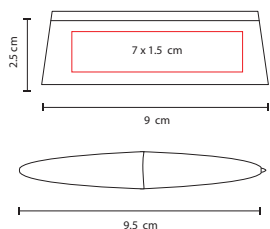

**Material:** Metal  
**Medida:** 9.5 cm Bolígrafo /  
9 x 2.5 cm Porta Clip  
**Área de Impresión:** 7 x 1.5 cm Porta Clip  
**Técnica de Impresión:** Láser  
**Colores:** Negro  
**Tinta:** Negra

Incluye porta clip imantado y bolígrafo color negro. No incluye clips.



## PRO 300

PORTA CLIPS MAGNET



**Material:** Madera  
**Medida:** 12.5 x 4 x 17 cm  
**Área de Impresión:** 8 x 10 cm  
**Técnica de Impresión:** Láser  
**Colores:** Madera

Reconocimiento artesanal fabricado en madera de recuperación. Hecho a mano. Piezas únicas con diseños y medidas similares que puede presentar variaciones entre sí.



## RCO 001

RECONOCIMIENTO DE  
MADERA

VESUBIO  
RECONOCIMIENTOS



PRO 030

PORTA GAFETE GAURI

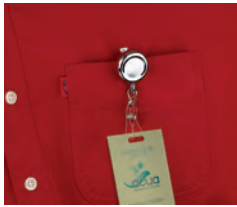

**Material:** Metal  
**Medida:** 3.2 x 8 cm  
**Área de Impresión:** 2.2 cm Diámetro  
**Técnica de Impresión:** Goteado en Resina  
**Colores:** Plata

Cordón de 70 cm. Incluye clip porta tarjetas.

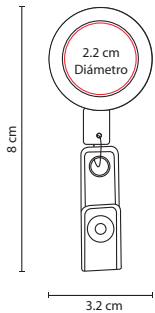

PRO 027

PORTA GAFETE RETRÁCTIL



R



N

A

B



**Material:** Plástico  
**Medida:** 3.3 x 8.4 cm  
**Área de Impresión:** 2.2 cm Diámetro  
**Técnica de Impresión:** Goteado en Resina  
**Colores:** A/B/N/R

Cordón de 85 cm. Incluye clip porta tarjetas.

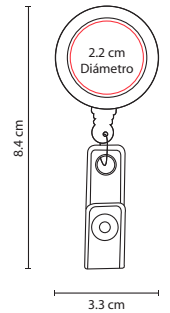

PRO 012

PORTA GAFETE ALBI



A



B

N

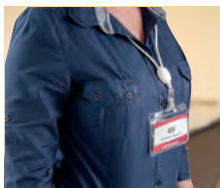

**Material:** Plástico  
**Medida:** 3.2 x 50 cm  
**Área de Impresión:** 2.6 cm Diámetro  
**Técnica de Impresión:** Serigrafía  
**Colores:** A/B/N/R

Incluye clip porta tarjetas.



R

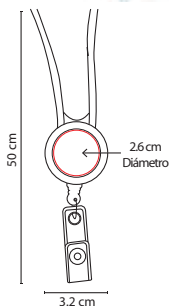

PRO 052

PORTA MENSAJES MEMORY

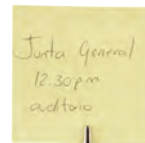

B

A

R



N

**Material:** Plástico  
**Medida:** 4.7 x 11.5 cm  
**Área de Impresión:** 3 x 1 cm  
**Técnica de Impresión:** Serigrafía / Tampografía  
**Colores:** A/B/N/R

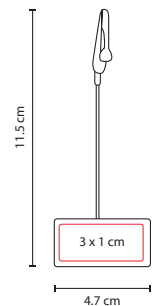



## AGB 014

AGENDA DE BOLSILLO  
Z E G N O®



V



A



T



N



C

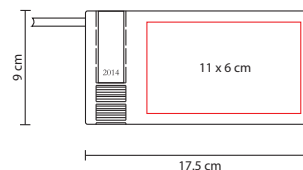

**Material:** Curpiel  
**Medida:** 17.5 x 9 cm  
**Área de Impresión:** 11 x 6 cm  
**Técnica de Impresión:** Láser / Serigrafía / Termograbado  
**Colores:** A/C/N/T/V

Contiene calendario 2014, calendarios 2013-2015, planeador 2014, tablas de conversión, claves de larga distancia nacional e internacional, tabla de distancias, programador anual, agenda semanal con días festivos y directorio telefónico. Incluye caja individual.

## AGBT 014

AGENDA DE BOLSILLO  
TERRA  
Z E G N O®



M



P



A



R



V



O

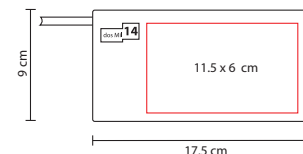
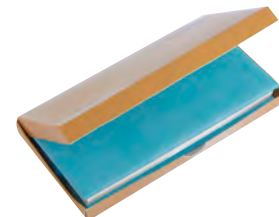

**Material:** Curpiel  
**Medida:** 17.5 x 9 cm  
**Área de Impresión:** 11.5 x 6 cm  
**Técnica de Impresión:** Láser / Serigrafía / Termograbado  
**Colores:** A/M/O/P/R/V

Contiene calendario 2014, calendarios 2013-2015, planeador 2014, tablas de conversión, claves de larga distancia nacional e internacional, tabla de distancias, agenda semanal con días festivos y directorio telefónico. Incluye caja individual.



AGT 014

AGENDA DIARIA TERRA  
Z E G N O®

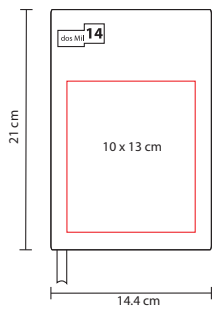

**Material:** Curpiel  
**Medida:** 14.4 x 21 cm  
**Área de Impresión:** 10 x 13 cm  
**Técnica de Impresión:** Láser /  
 Serigrafía / Termograbado  
**Colores:** A/M/O/P/R/V



O



M



A



P



V



R



Contiene calendarios 2013-2015, calendario 2014, planeador 2014, tablas de conversión, claves de larga distancia nacional e internacional, tabla de distancias, agenda diaria con días festivos, directorio telefónico y mapas. Incluye caja individual.



# AGD 014

AGENDA DIARIA  
Z E G N O®

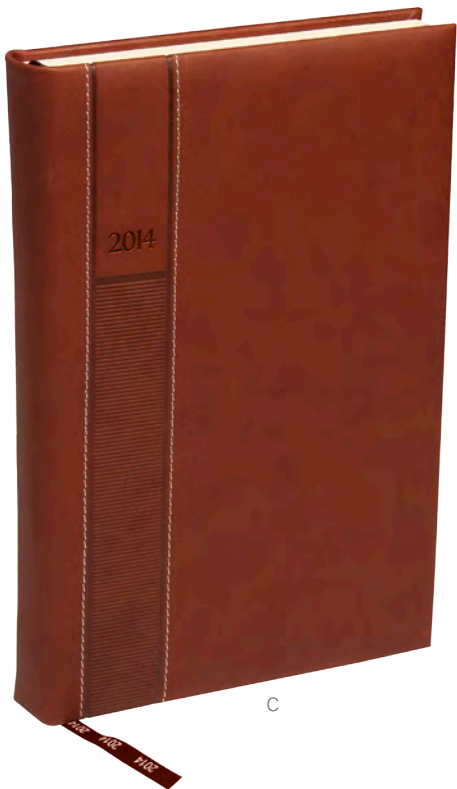

C



A

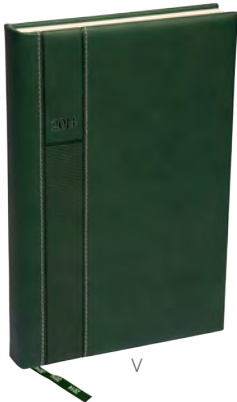

V



T



N

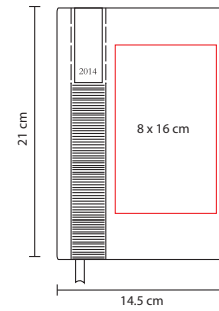

**Material:** Curpiel  
**Medida:** 14.5 x 21 cm  
**Área de Impresión:** 8 x 16 cm  
**Técnica de Impresión:** Láser / Serigrafía / Termograbado  
**Colores:** A/C/N/T/V



Contiene calendarios 2013-2015, calendario 2014, planeador 2014, programador anual, presupuesto de gastos, tablas de conversión, claves de larga distancia nacional e internacional, tabla de distancias, agenda diaria con días festivos, directorio telefónico y mapas. Incluye caja individual.





## AGE 014

AGENDA EJECUTIVA  
Z E G N O®

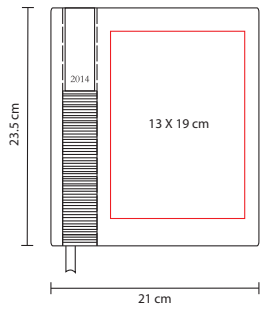

**Material:** Curpiel  
**Medida:** 21 x 23.5 cm  
**Área de Impresión:** 13 x 19 cm  
**Técnica de Impresión:** Láser / Serigrafía / Termograbado  
**Colores:** A/C/N/T/V

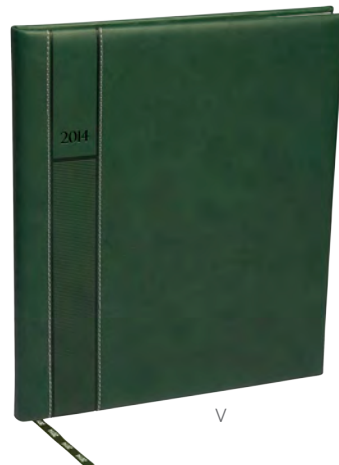
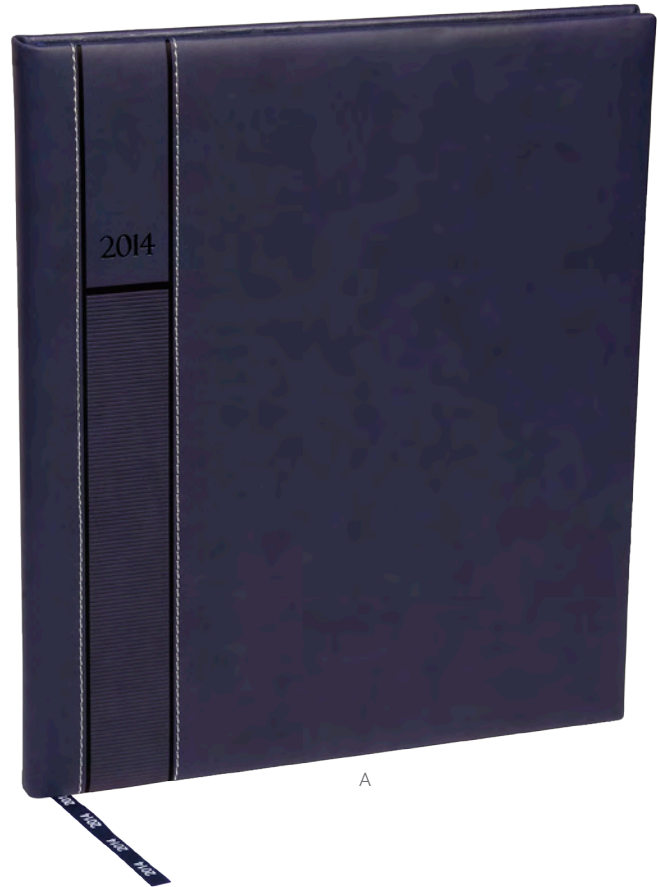

Contiene calendarios 2013-2015, calendario 2014, planeador 2014, programador anual, presupuesto de gastos, mantenimiento del automóvil, tablas de conversión, claves de larga distancia nacional e internacional, tabla de distancias, agenda semanal con días festivos, directorio telefónico y mapas. Incluye caja individual.

M 80100

CARPETA SOLARA

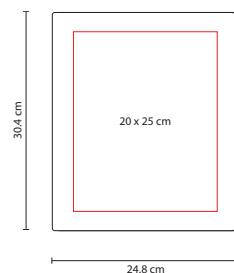

**Material:** Plástico  
**Medida:** 24.8 x 30.4 cm  
**Área de Impresión:** 20 x 25 cm  
**Técnica de Impresión:** Serigrafía  
**Colores:** Negro

Incluye block de raya de 20 hojas. Medida 29.4 x 21 cm. No incluye bolígrafo.

M 82724

CARPETA HARBEL

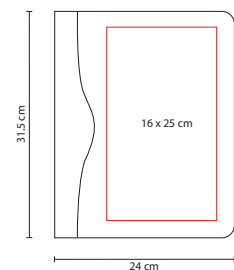

**Material:** Curpiel  
**Medida:** 24 x 31.5 cm  
**Área de Impresión:** 16 x 25 cm  
**Técnica de Impresión:** Serigrafía / Termograbado  
**Colores:** Negro

Incluye block de raya de 20 hojas. Medida 29.4 x 21 cm. No incluye bolígrafo.

M 80444

CARPETA CENTURY

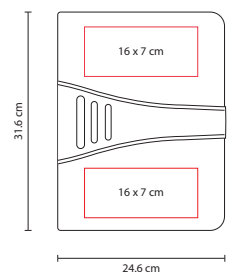

**Material:** Curpiel  
**Medida:** 24.6 x 31.6 cm  
**Área de Impresión:** 16 x 7 cm  
**Técnica de Impresión:** Serigrafía / Termograbado  
**Colores:** Negro

Incluye block de raya de 20 hojas. Medida 29.4 x 21 cm. No incluye bolígrafo.



M 80719

CARPETA MARADY  
CON CALCULADORA

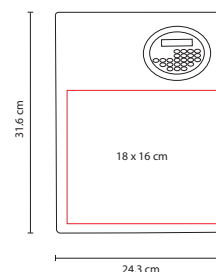

**Material:** Curpiel  
**Medida:** 24.3 x 31.6 cm  
**Área de Impresión:** 18 x 16 cm  
**Técnica de Impresión:** Serigrafía / Termograbado  
**Colores:** Negro

Incluye block de raya de 20 hojas. Medida 29.4 x 21 cm. No incluye bolígrafo.

M 83300

CARPETA MUSSI CON  
CALCULADORA

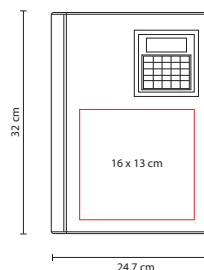

**Material:** Curpiel  
**Medida:** 24.7 x 32 cm  
**Área de Impresión:** 16 x 13 cm  
**Técnica de Impresión:** Serigrafía / Termograbado  
**Colores:** Negro con Gris

Incluye block de raya de 20 hojas. No incluye bolígrafo.

M 80555

CARPETA CENTURY  
CON CALCULADORA

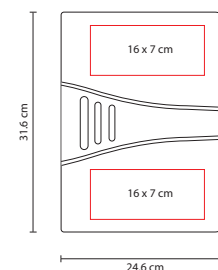

**Material:** Curpiel  
**Medida:** 24.6 x 31.6 cm  
**Área de Impresión:** 16 x 7 cm  
**Técnica de Impresión:** Serigrafía / Termograbado  
**Colores:** Negro

Incluye block de raya de 20 hojas. Medida 29.4 x 21 cm. No incluye bolígrafo.



M 81200

CARPETA ÉVORA

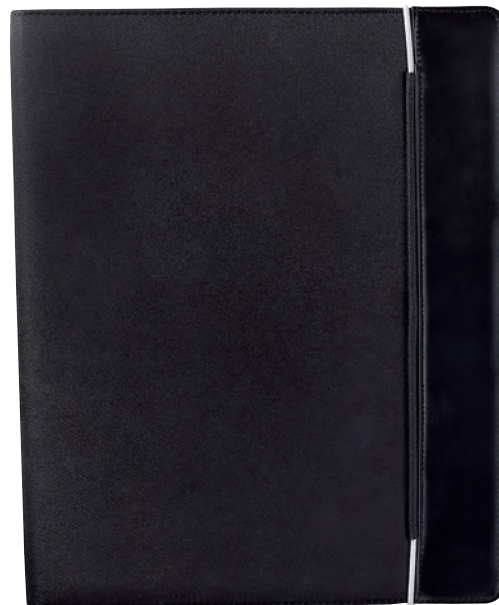
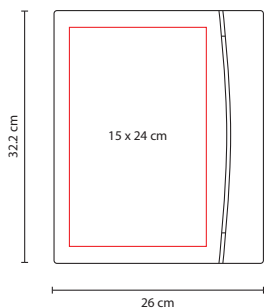

**Material:** Curpiel / Microfibra  
**Medida:** 26 x 32.2 cm  
**Área de Impresión:** 15 x 24 cm  
**Técnica de Impresión:** Serigrafía / Termograbado  
**Colores:** Negro

Carpeta con elástico. Incluye block de raya tamaño A4 con 20 hojas y elástico para bolígrafo. No incluye bolígrafo.



M 80600

CARPETA MILÁN

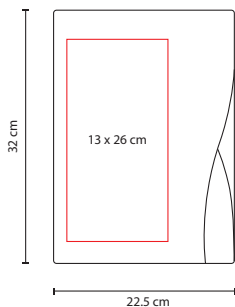

**Material:** Poliéster  
**Medida:** 22.5 x 32 cm  
**Área de Impresión:** 13 x 26 cm  
**Técnica de Impresión:** Serigrafía  
**Colores:** Negro con Filos en Plata

Incluye block de raya tamaño A4 con 20 hojas y elástico para bolígrafo. No incluye bolígrafo.

M 82100

CARPETA ORGANIZADORA FORUM



A



R

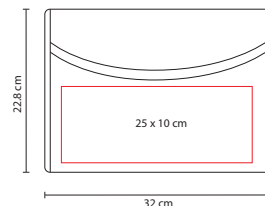

**Material:** Plástico  
**Medida:** 32 x 22.8 cm  
**Área de Impresión:** 25 x 10 cm  
**Técnica de Impresión:** Serigrafía  
**Colores:** A/R

Incluye block de raya de 15 hojas.

M 80400

CARPETA BIRKET



R



A

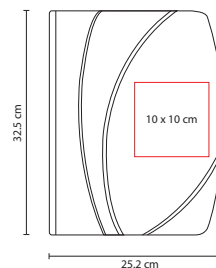

**Material:** Curpiel  
**Medida:** 25.2 x 32.5 cm  
**Área de Impresión:** 10 x 10 cm  
**Técnica de Impresión:** Láser / Serigrafía / Termograbado  
**Colores:** A/R

Incluye block de raya de 20 hojas.

M 80500

CARPETA FROMBORK



R



A

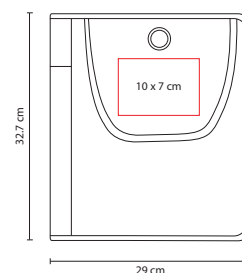

**Material:** Plástico / Poliéster  
**Medida:** 29 x 32.7 cm  
**Área de Impresión:** 10 x 7 cm  
**Técnica de Impresión:** Serigrafía  
**Colores:** A/R

Aditamento especial para audífonos. No incluye block de notas. Bolígrafos y audífonos no incluidos.

## M 80700

### CARPETA GRECIA

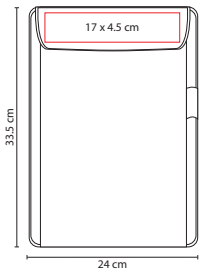

**Material:** Curpiel  
**Medida:** 24 x 33.5 cm  
**Área de Impresión:** 17 x 4.5 cm  
**Técnica de Impresión:** Serigrafía / Termograbado  
**Colores:** A/R



R



A

Carpeta de notas. Incluye block de raya tamaño A4 con 20 hojas y elástico para bolígrafo.

## M 80200

### CARPETA NATURE

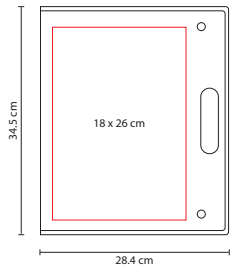

**Material:** Cartón / Papel Reciclado  
**Medida:** 28.4 x 34.5 cm  
**Área de Impresión:** 18 x 26 cm  
**Técnica de Impresión:** Serigrafía  
**Colores:** Café  
**Tinta:** Negra



Carpeta ecológica. Incluye block de raya tamaño A4 con 20 hojas. Incluye bolígrafo tinta negra y notas adheribles.

## M 81300

### CARPETA RECORD

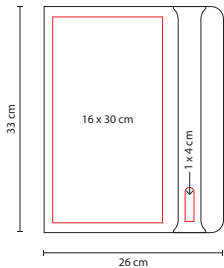

**Material:** Curpiel  
**Medida:** 26 x 33 cm  
**Área de Impresión:** 16 x 30 cm Curpiel / 1 x 4 cm en Placa Metálica  
**Técnica de Impresión:** Láser / Serigrafía / Termograbado  
**Colores:** Negro



Carpeta con cierre y placa metálica. Incluye block de raya tamaño A4 con 20 hojas. Incluye elástico para bolígrafo.

M 80800

CARPETA LISBOA



N



C

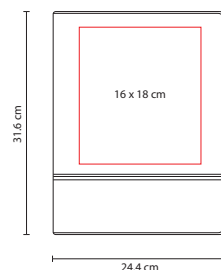

**Material:** Curpiel  
**Medida:** 24.4 x 31.6 cm  
**Área de Impresión:** 16 x 18 cm  
**Técnica de Impresión:** Serigrafía / Termograbado  
**Colores:** C/N

Incluye block de raya tamaño A4 con 20 hojas. Medida 29.4 x 21 cm. No incluye bolígrafo.

M 80900

CARPETA LOUISIANA



C



N

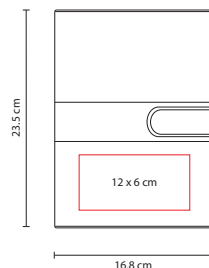

**Material:** Curpiel  
**Medida:** 16.8 x 23.5 cm  
**Área de Impresión:** 12 x 6 cm  
**Técnica de Impresión:** Serigrafía / Termograbado  
**Colores:** C/N

Incluye 88 hojas de raya tamaño A4. Medida 14 x 21 cm. No incluye bolígrafo.

SIN 014

CARPETA PORTAFOLIO

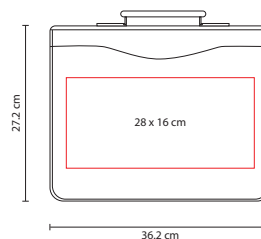

**Material:** Curpiel  
**Medida:** 36.2 x 27.2 cm  
**Área de Impresión:** 28 x 16 cm  
**Técnica de Impresión:** Láser / Serigrafía  
**Colores:** Negro

Carpeta portafolio. No incluye bolígrafo.



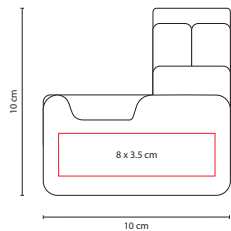

**Material:** Metal  
**Medida:** 10 x 10 cm Abierto  
**Área de Impresión:** 8 x 3.5 cm  
**Técnica de Impresión:** Láser / Serigrafía  
**Colores:** Plata

Calendario universal.



## CAL 100

CALENDARIO ONTUR

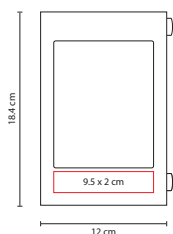

**Material:** Plástico  
**Medida:** 12 x 18.4 cm  
**Área de Impresión:** 9.5 x 2 cm  
**Técnica de Impresión:** Serigrafía  
**Colores:** Negro

Calendario 2014-2015.



## CAL 010

CALENDARIO MOVE IT

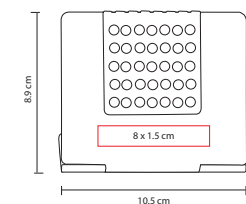

**Material:** Aluminio  
**Medida:** 10.5 x 8.9 cm  
**Área de Impresión:** 8 x 1.5 cm  
**Técnica de Impresión:** Láser / Pantógrafo  
**Colores:** Plata

Calendario universal.

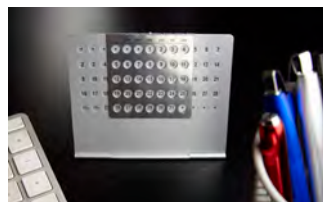

## CAL 005

CALENDARIO MONTECARLO

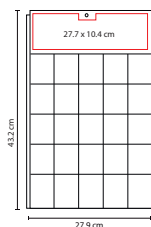

**Material:** Cartoncillo / Papel Bond  
**Medida:** 27.9 x 43.2 cm  
**Área de Impresión:** 27.7 x 10.4 cm  
**Técnica de Impresión:** Serigrafía  
**Colores:** Gris con Blanco

Calendario vertical 2014. Incluye días festivos, recordatorio de pagos y notas.



## CAL 2014

CALENDARIO ORGANIZADOR



**HL 3500**MINI LIBRETA EXPO  
CON CORDÓN

Y



N



O



R



V



A

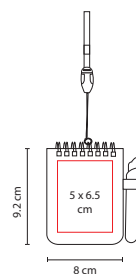
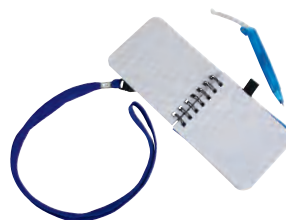

**Material:** Espiral Metálico / Plástico  
**Medida:** 8 x 9.2 cm  
**Área de Impresión:** 5 x 6.5 cm  
**Técnica de Impresión:** Serigrafía  
**Colores:** A/O/N/R/V/Y

60 Hojas de raya. Incluye bolígrafo tinta negra y cordón.

**HL 150**LIBRETA CON ESPEJO  
Y PORTA TARJETAS

R



A



B



O



V

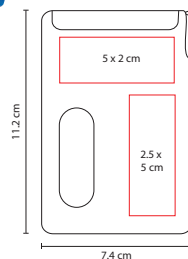

**Material:** Plástico  
**Medida:** 7.4 x 11.2 cm  
**Área de Impresión:** 5 x 2 cm  
**Técnica de Impresión:** Serigrafía  
**Colores:** A/B/O/R/V

Incluye bolígrafo tinta negra, espejo, libreta y porta tarjetas.

**HL 2009**

LIBRETA BALI



A



B



Y



O



R



V

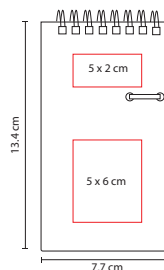

**Material:** Espiral Metálico / Plástico  
**Medida:** 7.7 x 13.4 cm  
**Área de Impresión:** 5 x 6 cm  
**Técnica de Impresión:** Serigrafía  
**Colores:** A/B/O/R/V/Y

80 Hojas de raya. Incluye bolígrafo tinta negra.

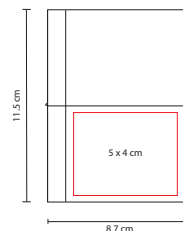

**CT 004**LIBRETA  
CALCULADORA DUO

**Material:** Cartón / Plástico  
**Medida:** 8.7 x 11.5 cm  
**Área de Impresión:** 5 x 4 cm  
**Técnica de Impresión:** Serigrafía  
**Colores:** Blanco con Negro

Incluye calculadora de 8 dígitos, libreta de notas, bolígrafo tinta negra y baterías.

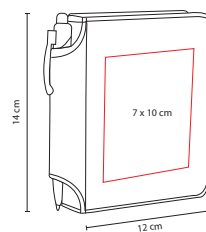
**HL 8000**LIBRETA  
CALCULADORA  
PHUKET

**Material:** Curpiel / Espiral Metálico  
**Medida:** 12 x 14 cm  
**Área de Impresión:** 7 x 10 cm  
**Técnica de Impresión:** Serigrafía  
**Colores:** Plata con Negro

Incluye calculadora solar de 8 dígitos, 60 hojas de raya y bolígrafo tinta negra.

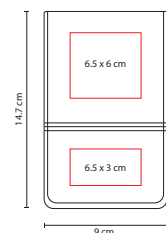
**HL 7400**LIBRETA DE BOLSILLO  
CON CALCULADORA

**Material:** Curpiel  
**Medida:** 9 x 14.7 cm  
**Área de Impresión:** 6.5 x 6 cm  
**Técnica de Impresión:** Láser / Serigrafía  
**Colores:** A/N/R/S

Incluye calculadora solar de 8 dígitos y 30 hojas de notas. No incluye bolígrafo.

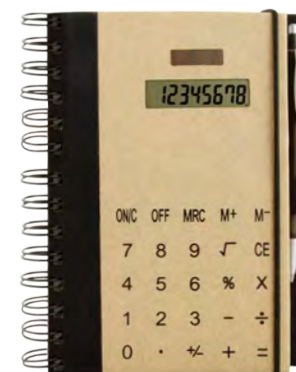
**CT 400**LIBRETA  
CALCULADORA  
ECOWORLD

**Material:** Cartón / Espiral Metálico /  
Papel Reciclado  
**Medida:** 14.3 x 17.8 cm  
**Área de Impresión:** 6.5 x 3 cm  
**Técnica de Impresión:** Serigrafía  
**Colores:** Café con Negro

Incluye calculadora solar 8 dígitos, 100 hojas de raya y bolígrafo tinta negra.

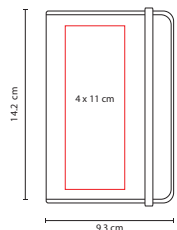

## HL 1600

LIBRETA CARDEX

**Material:** Curpiel  
**Medida:** 9,3 x 14,2 cm  
**Área de Impresión:** 4 x 11 cm  
**Técnica de Impresión:** Serigrafía / Termograbado  
**Colores:** A/C/N/R



C



N



A



R

60 Hojas de raya. Incluye separador de hojas.

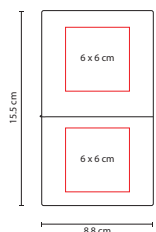

## HL 1650

LIBRETA VALANTI

**Material:** Curpiel  
**Medida:** 8,8 x 15,5 cm  
**Área de Impresión:** 6 x 6 cm  
**Técnica de Impresión:** Serigrafía / Termograbado  
**Colores:** A/C/N/R



A



N



R



C

70 Hojas de raya. Incluye separador de hojas.

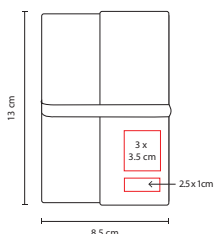

## HL 1500

LIBRETA SCRIF

**Material:** Curpiel  
**Medida:** 8,5 x 13 cm  
**Área de Impresión:** 3 x 3,5 cm Curpiel / 2,5 x 1 cm Placa Metálica  
**Técnica de Impresión:** Láser / Serigrafía  
**Colores:** C/N



C



N



240 Hojas de raya. Incluye separador de hojas y placa para grabado.

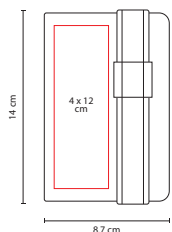

## HL 1550

LIBRETA ECOLIER

**Material:** Cartón  
**Medida:** 8,7 x 14 cm  
**Área de Impresión:** 4 x 12 cm  
**Técnica de Impresión:** Serigrafía  
**Colores:** A/R/V



A

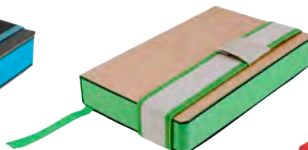

V



R



240 Hojas de raya. Incluye separador de hojas.

## HL 2010

LIBRETA ECOLÓGICA  
GREEN PLANET



R



N



A

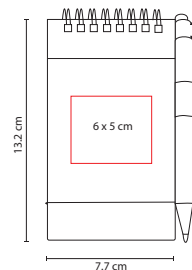

**Material:** Cartón / Espiral Metálico /  
Papel Reciclado

**Medida:** 7.7 x 13.2 cm

**Área de Impresión:** 6 x 5 cm

**Técnica de Impresión:** Serigrafía

**Colores:** A/N/R

**Tinta:** Negra

50 Hojas de raya. Incluye bolígrafo ecológico tinta negra de cartón reciclado.

## HL 1100

LIBRETA ECOLÓGICA  
JOLIET

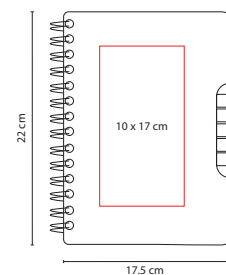
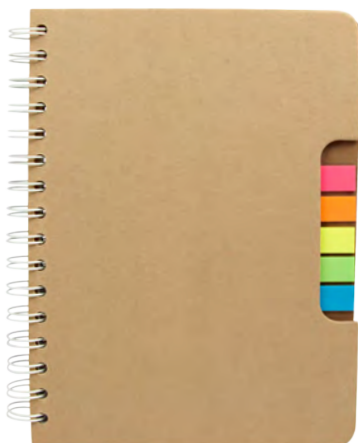

**Material:** Cartón / Espiral Metálico

**Medida:** 17.5 x 22 cm

**Área de Impresión:** 10 x 17 cm

**Técnica de Impresión:** Serigrafía

**Colores:** Café

**Tinta:** Negra

100 Hojas de raya. Incluye notas adheribles en 5 colores y bolígrafo ecológico tinta negra. Espiral metálico doble.

## HL 2012

LIBRETA ECO PAPER



A



N



R

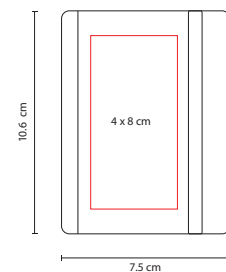

**Material:** Cartón / Papel Reciclado

**Medida:** 7.5 x 10.6 cm

**Área de Impresión:** 4 x 8 cm

**Técnica de Impresión:** Serigrafía

**Colores:** A/N/R

60 Hojas de raya.

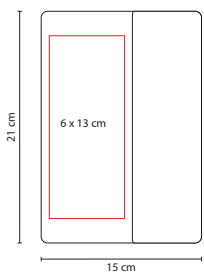

## HL 2100

LIBRETA BOK

**Material:** Curpiel  
**Medida:** 15 x 21 cm  
**Área de Impresión:** 6 x 13 cm  
**Técnica de Impresión:** Láser / Serigrafía / Termograbado  
**Colores:** C/O/V



V



C



O

80 Hojas de raya. Libreta con broche magnético y separador de hojas.

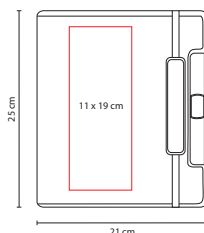
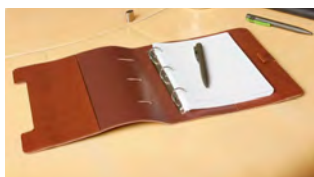

## HL 1505

LIBRETA DANBY

ZEGNO®  
ESCRITURA

**Material:** Curpiel  
**Medida:** 21 x 25 cm  
**Área de Impresión:** 11 x 19 cm  
**Técnica de Impresión:** Láser / Serigrafía / Termograbado  
**Colores:** A/C/N



C



N



A

100 Hojas de raya. Incluye separador elástico y porta bolígrafo. Arillo de 1 pulgada. Bolígrafo no incluido.

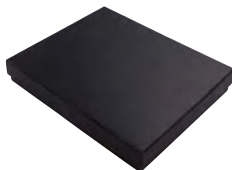
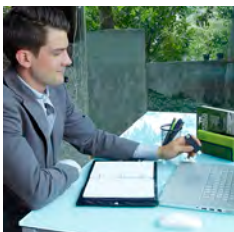

## HL 1800

LIBRETA FARA

ZEGNO®  
ESCRITURA

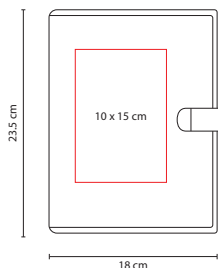

**Material:** Curpiel / Metal  
**Medida:** 18 x 23.5 cm  
**Área de Impresión:** 10 x 15 cm  
**Técnica de Impresión:** Láser / Serigrafía / Termograbado  
**Colores:** Negro  
**Capacidad:** 4 GB



100 Hojas de raya tamaño esquila. Incluye bolígrafo metálico tinta negra y broche USB desprendible de 4 GB. Compartimentos para tarjetas y documentos. Arillo de 1 pulgada. Incluye caja de regalo.



### HL 5600

LIBRETA KENTIA

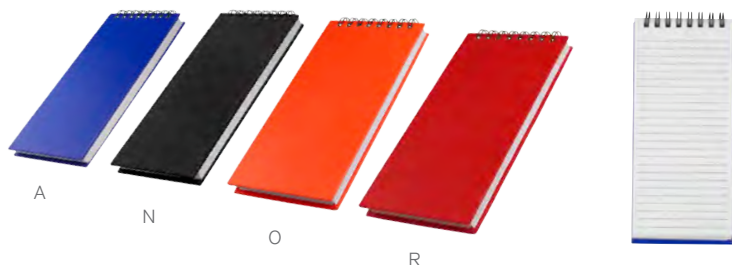

V

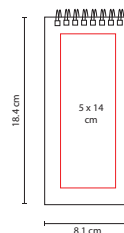

**Material:** Cartón / Espiral Metálico  
**Medida:** 8.1 x 18.4 cm  
**Área de Impresión:** 5 x 14 cm  
**Técnica de Impresión:** Serigrafía  
**Colores:** A/N/O/R/V

80 Hojas de raya.



### HL 1700

LIBRETA TADIA

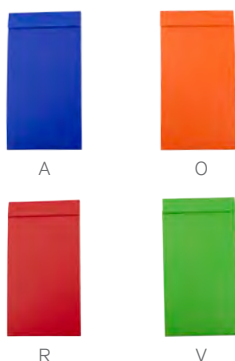

Y

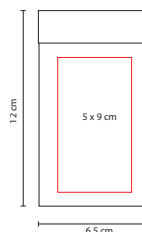
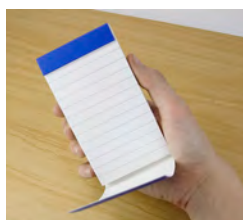

**Material:** Cartón / Papel  
**Medida:** 6.5 x 12 cm  
**Área de Impresión:** 5 x 9 cm  
**Técnica de Impresión:** Serigrafía  
**Colores:** A/O/R/V/Y

30 Hojas de raya desprendibles.



### HL 900

LIBRETA ALDEBARÁN



O

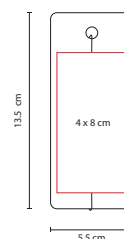

**Material:** Cartón / Papel Reciclado  
**Medida:** 5.5 x 13.5 cm  
**Área de Impresión:** 4 x 8 cm  
**Técnica de Impresión:** Serigrafía  
**Colores:** A/N/O/R/V/Y

60 Hojas de rayas con elástico.



### HL 2900

CUADERNO PROFESIONAL



A

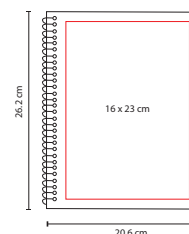

**Material:** Cartón / Espiral Metálico  
**Medida:** 20.6 x 26.2 cm  
**Área de Impresión:** 16 x 23 cm  
**Técnica de Impresión:** Serigrafía  
**Colores:** A/N/O/R/V/Y

Cuaderno profesional tamaño carta.  
70 Hojas de raya.





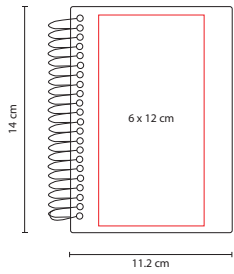
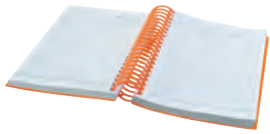

**Material:** Cartón / Espiral Plástico  
**Medida:** 11.2 x 14 cm  
**Área de Impresión:** 6 x 12 cm  
**Técnica de Impresión:** Serigrafía  
**Colores:** A/N/O/R/V

90 Hojas de raya.



A



V



N



R



O

## HL 1300

LIBRETA WENDEL

## HL 1200

LIBRETA MOND

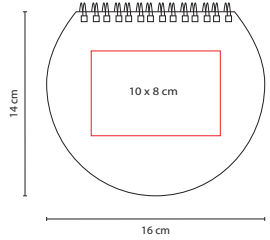

**Material:** Cartón / Espiral Metálico  
**Medida:** 16 x 14 cm  
**Área de Impresión:** 10 x 8 cm  
**Técnica de Impresión:** Serigrafía  
**Colores:** A/O/R/V/Y

60 Hojas de raya. Espiral doble metálico de color.

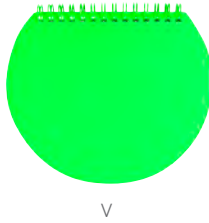

V

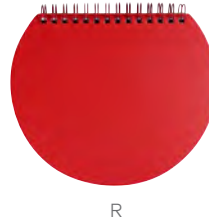

R

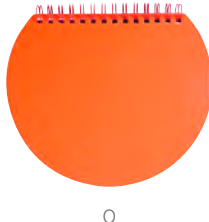

O

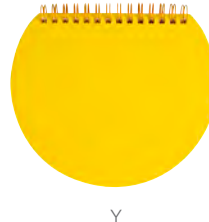

Y



A

## HL 500

LIBRETA HADAR

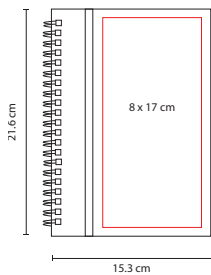

**Material:** Curpiel / Espiral Metálico  
**Medida:** 15.3 x 21.6 cm  
**Área de Impresión:** 8 x 17 cm  
**Técnica de Impresión:** Serigrafía / Termograbado  
**Colores:** A/N/R

65 Hojas de raya.



N



A



R

## HL 2720

BLOCK DE NOTAS  
CON BOLÍGRAFO

A



B



R

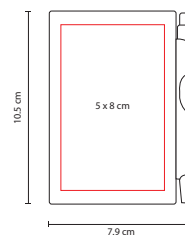

**Material:** Plástico  
**Medida:** 7.9 x 10.5 cm  
**Área de Impresión:** 5 x 8 cm  
**Técnica de Impresión:** Serigrafía  
**Colores:** A/B/R

60 Hojas. Incluye bolígrafo tinta negra.

## HL 5000

LIBRETA FRESH



N



A



O



V



R

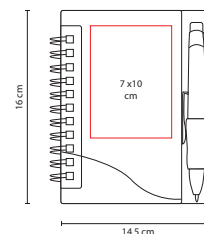

**Material:** Espiral Metálico / Plástico  
**Medida:** 14.5 x 16 cm  
**Área de Impresión:** 7 x 10 cm  
**Técnica de Impresión:** Serigrafía  
**Colores:** A/N/O/R/V

100 Hojas de raya. Incluye bolígrafo tinta negra.

## HL 6000

LIBRETA FUN-WORK



V

Comparativo de tamaño  
HL 5000 y HL 6000

O



A



N



R

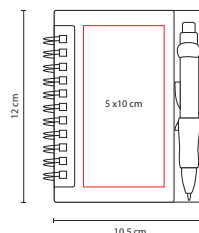

**Material:** Espiral Metálico / Plástico  
**Medida:** 10.5 x 12 cm  
**Área de Impresión:** 5 x 10 cm  
**Técnica de Impresión:** Serigrafía  
**Colores:** A/N/O/R/V

60 Hojas de raya. Incluye bolígrafo tinta negra.

## HL 2000

LIBRETA BARCELONA



O



V



A



R

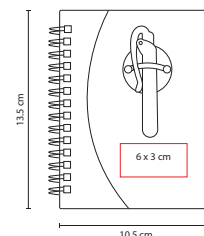

**Material:** Espiral Metálico / Plástico  
**Medida:** 10.5 x 13.5 cm  
**Área de Impresión:** 6 x 3 cm  
**Técnica de Impresión:** Serigrafía  
**Colores:** A/O/R/V

80 Hojas de raya. Incluye bolígrafo tinta negra.

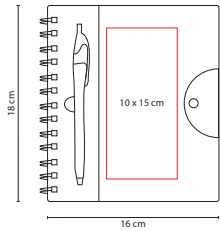

**Material:** Espiral Metálico / Plástico  
**Medida:** 16 x 18 cm  
**Área de Impresión:** 10 x 15 cm  
**Técnica de Impresión:** Serigrafía  
**Colores:** A/N/R



N

## HL 1400

### LIBRETA BREKA



A



R

100 Hojas de raya. Incluye bolígrafo tinta negra. Espiral doble metálico.

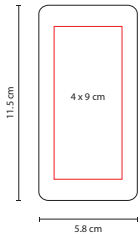

**Material:** Plástico  
**Medida:** 5.8 x 11.5 cm  
**Área de Impresión:** 4 x 9 cm  
**Técnica de Impresión:** Serigrafía  
**Colores:** Blanco

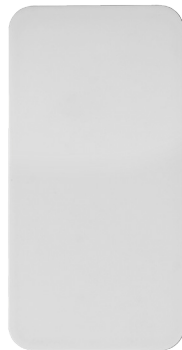

## HL 8400

### BLOCK DE NOTAS CONTÉ



Block de notas de 50 hojas en blanco. Incluye bolígrafo tinta negra.

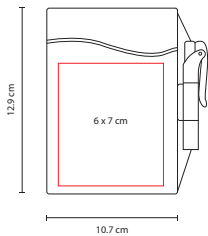

**Material:** Plástico  
**Medida:** 10.7 x 12.9 cm  
**Área de Impresión:** 6 x 7 cm  
**Técnica de Impresión:** Serigrafía  
**Colores:** A/N/R



A



N

## HL 2011

### LIBRETA LEVIN



R

70 Hojas de raya. Incluye bolígrafo tinta negra.

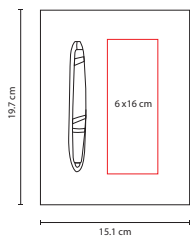

**Material:** Cartón  
**Medida:** 15.1 x 19.7 cm  
**Área de Impresión:** 6 x 16 cm  
**Técnica de Impresión:** Serigrafía  
**Colores:** Negro



## HL 4000

### LIBRETA VÉRTIGO



140 Hojas de raya. Incluye bolígrafo tinta negra.

## TAZ 003

## TAZA VERONA



A



V

R



Y

N

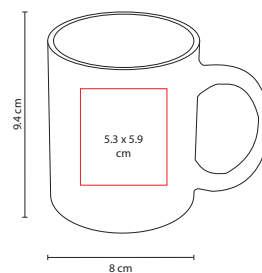

**Material:** Cerámica  
**Medida:** 8 x 9.4 cm  
**Área de Impresión:** 5.3 x 5.9 cm  
**Técnica de Impresión:** Grabado en Arena / Serigrafía / Termocalca  
**Colores:** A/N/R/V/Y  
**Capacidad:** 11 Oz

Venta caja cerrada de 36 piezas.

## TAZ 004

## TAZA SPINNER

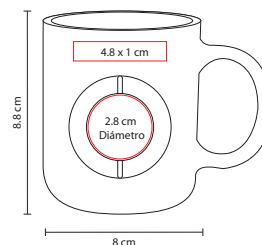

**Material:** Cerámica / Plástico  
**Medida:** 8 x 8.8 cm  
**Área de Impresión:** 2.8 cm Diámetro  
**Técnica de Impresión:** Goteado en Resina / Grabado en Arena / Serigrafía / Termocalca  
**Colores:** Blanca  
**Capacidad:** 10 Oz

Con pieza circular girable. No usar en microondas, ni lavavajillas. Venta individual.

## TAZ 001

## TAZA ESPIRIT



O



R

N

B



AR

V

A

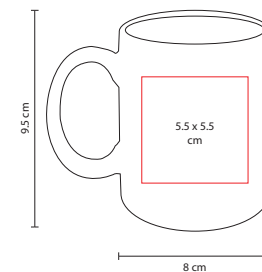

**Material:** Cerámica  
**Medida:** 8 x 9.5 cm  
**Área de Impresión:** 5.5 x 5.5 cm  
**Técnica de Impresión:** Grabado en Arena / Serigrafía / Termocalca  
**Colores:** A/AR/B/N/O/R/V  
**Capacidad:** 11 Oz

Venta caja cerrada de 36 piezas.



TMPS 200

TAZA TÉRMICA LOOP



V



N



A



Y

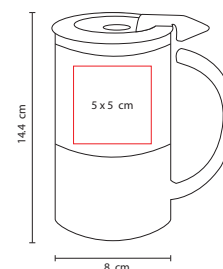

**Material:** Plástico / Acero Inoxidable  
**Medida:** 8 x 14.4 cm  
**Área de Impresión:** 5 x 5 cm  
**Técnica de Impresión:** Serigrafía / Tampografía  
**Colores:** A/N/V/Y  
**Capacidad:** 355 ml

Doble pared. Asa de plástico. Incluye válvula de seguridad giratoria.

TMPS 201

TAZA TÉRMICA WAKE CUP



O



R



A



V



N



Y

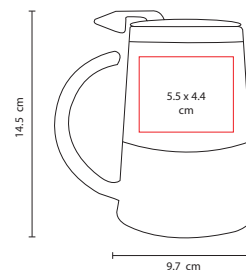

**Material:** Plástico / Acero Inoxidable  
**Medida:** 9.7 x 14.5 cm  
**Área de Impresión:** 5.5 x 4.4 cm  
**Técnica de Impresión:** Serigrafía / Tampografía  
**Colores:** A/N/O/R/V/Y  
**Capacidad:** 355 ml

Doble pared. Asa de plástico. Incluye válvula de seguridad giratoria.

TMPS 26

TAZA TÉRMICA BURGOS



T



A



Y



V



R



N

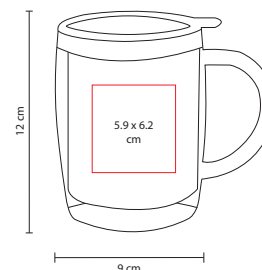

**Material:** Plástico / Acero Inoxidable  
**Medida:** 9 x 12 cm  
**Área de Impresión:** 5.9 x 6.2 cm  
**Técnica de Impresión:** Serigrafía / Tampografía  
**Colores:** A/N/R/T/V/Y  
**Capacidad:** 350 ml

Doble pared. Incluye válvula de seguridad giratoria con tapa de presión.

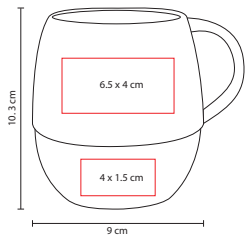

**Material:** Porcelana / Acero Inoxidable  
**Medida:** 9 x 10.3 cm  
**Área de Impresión:** 6.5 x 4 cm Porcelana / 4 x 1.5 cm Metal  
**Técnica de Impresión:** Láser / Pantógrafo / Tampografía  
**Colores:** A/R/S  
**Capacidad:** 12 Oz

Incluye caja de regalo. No usar en microondas ni lavavajillas. Venta individual.



S

A

TAZ 012

TAZA TAURÉ



R

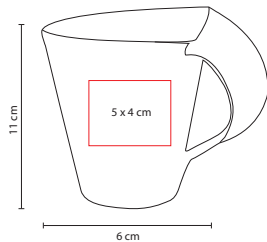

**Material:** Porcelana  
**Medida:** 6 x 11 cm  
**Área de Impresión:** 5 x 4 cm  
**Técnica de Impresión:** Grabado en Arena / Serigrafía / Tampografía / Termocalca  
**Colores:** A/N/O/R/V/Y  
**Capacidad:** 10 Oz

Venta individual.



O



R



Y



A



V



N

TAZ 014

TAZA BOGATI



TAZ 011

TAZA IRON

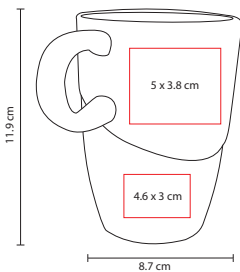

**Material:** Cerámica / Acero Inoxidable  
**Medida:** 8.7 x 11.9 cm  
**Área de Impresión:** 5 x 3.8 cm Cerámica / 4.6 x 3 cm Metal  
**Técnica de Impresión:** Láser / Pantógrafo / Tampografía  
**Colores:** A/B/N/R  
**Capacidad:** 16 Oz

No usar en microondas ni lavavajillas. Venta individual.

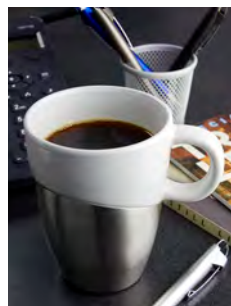

A



R



B



N



TAZ 002

TAZA DOLCE



V



Y

R



N

A

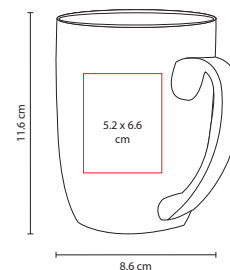

**Material:** Cerámica  
**Medida:** 8.6 x 11.6 cm  
**Área de Impresión:** 5.2 x 6.6 cm  
**Técnica de Impresión:** Grabado en Arena / Serigrafía / Termocalca  
**Colores:** A/N/R/V/Y  
**Capacidad:** 15 Oz

Venta caja cerrada de 36 piezas.

TAZ 005

TAZA MOFFY



A



R



N

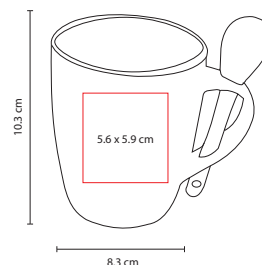

**Material:** Cerámica  
**Medida:** 8.3 x 10.3 cm  
**Área de Impresión:** 5.6 x 5.9 cm  
**Técnica de Impresión:** Grabado en Arena / Serigrafía / Termocalca  
**Colores:** A/N/R  
**Capacidad:** 11 Oz

Incluye cuchara. Venta caja cerrada de 36 piezas.

TAZ 010

TAZA MARSELLA



N



A



R

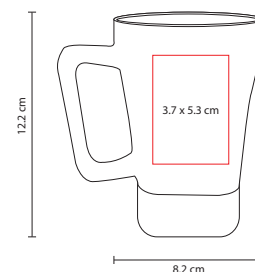

**Material:** Cerámica / Silicón  
**Medida:** 8.2 x 12.2 cm  
**Área de Impresión:** 3.7 x 5.3 cm  
**Técnica de Impresión:** Grabado en Arena / Serigrafía / Termocalca  
**Colores:** A/N/R  
**Capacidad:** 11 Oz

Cuenta con base de silicón. Venta individual.



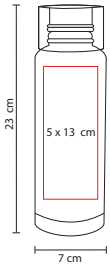

## TAZ 013

VASO IBERIA



**Material:** Cerámica / Silicón  
**Medida:** 7 x 23 cm  
**Área de Impresión:** 5 x 13 cm  
**Técnica de Impresión:** Grabado en Arena / Serigrafía / Tampografía / Termocalca  
**Colores:** A/M/O/R/V  
**Capacidad:** 20 Oz



Vaso de pared sencilla, cuenta con base y boquilla de silicón. Venta individual.

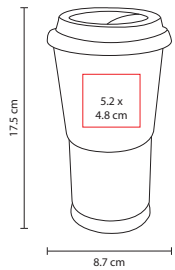

## TAZ 007

VASO VENETTA



**Material:** Cerámica / Silicón  
**Medida:** 8.7 x 17.5 cm  
**Área de Impresión:** 5.2 x 4.8 cm  
**Técnica de Impresión:** Serigrafía / Tampografía  
**Colores:** A/N/O/R/V/Y  
**Capacidad:** 410 ml



Vaso de pared sencilla con recubrimiento y tapa de silicón. No usar en microondas y lavavajillas. Venta individual.

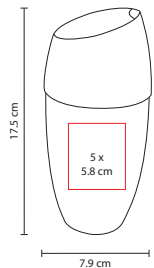

## TAZ 009

VASO FLORENCIA



**Material:** Cerámica / Silicón  
**Medida:** 7.9 x 17.5 cm  
**Área de Impresión:** 5 x 5.8 cm  
**Técnica de Impresión:** Grabado en Arena / Serigrafía / Termocalca  
**Colores:** A/N/R  
**Capacidad:** 10 Oz

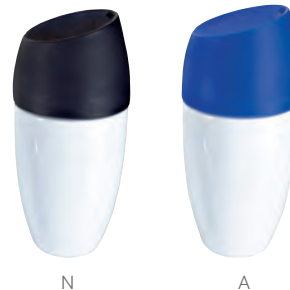

Doble pared. Con tapa de silicón. Venta individual.



A

TT 050

ÁNFORA FREEZE



R

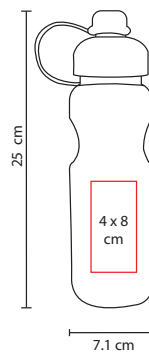

**Material:** Plástico  
**Medida:** 7.1 x 25 cm  
**Área de Impresión:** 4 x 8 cm  
**Técnica de Impresión:** Serigrafía / Tampografía  
**Colores:** A/R  
**Capacidad:** 600 ml

Con barra para enfriar agua, gel no tóxico.



R

ANF 005

ÁNFORA MABIRA



B



A

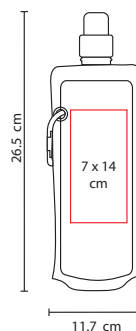

**Material:** Plástico  
**Medida:** 11.7 x 26.5 cm  
**Área de Impresión:** 7 x 14 cm  
**Técnica de Impresión:** Serigrafía  
**Colores:** A/B/R  
**Capacidad:** 500 ml

Enrollable. Incluye gancho.



01

SOC 180

ÁNFORA DEPORTIVA



02



03



04



05



06



07

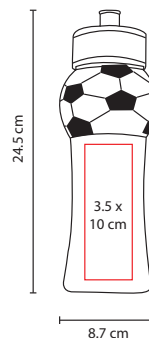

**Material:** PET  
**Medida:** 8.7 x 24.5 cm  
**Área de Impresión:** 3.5 x 10 cm  
**Técnica de Impresión:** Serigrafía / Tampografía  
**Colores:** Blanco  
**Capacidad:** 700 ml

Peso 44 grs. sin tapa. Con válvula de seguridad.



ANF 004

ÁNFORA SHADOW

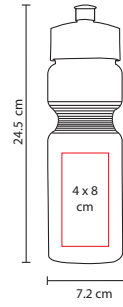

**Material:** PET  
**Medida:** 7,2 x 24,5 cm  
**Área de Impresión:** 4 x 8 cm  
**Técnica de Impresión:** Serigrafía /  
Tampografía  
**Colores:** A/B/H/R/V/Y/  
AS/BS/OS/RS/SS/VS/YS  
**Capacidad:** 700 ml

Peso 44 grs. sin tapa. Con válvula de seguridad.



AS



BS



YS



VS



OS



RS



SS



V



H



B



R



Y



A

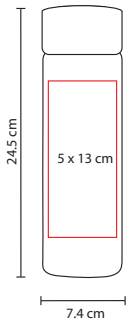

**Material:** PET  
**Medida:** 7.4 x 24.5 cm  
**Área de Impresión:** 5 x 13 cm  
**Técnica de Impresión:** Serigrafía / Tampografía  
**Colores:** A/H/O/R/V/Y  
**Capacidad:** 850 ml

Tapa con sistema de rosca.



ANF 007  
 ÁNFORA SPRING

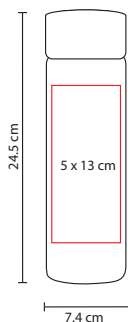

**Material:** PET  
**Medida:** 7.4 x 24.5 cm  
**Área de Impresión:** 5 x 13 cm  
**Técnica de Impresión:** Serigrafía / Tampografía  
**Colores:** A/B/H/N/O/R/V/Y  
**Capacidad:** 850 ml

Tapa con sistema de rosca.



ANF 006  
 ÁNFORA LAKE



ANF 003

ÁNFORA TWISTER



Y



V



H



B

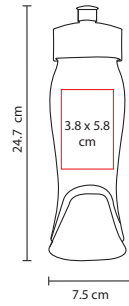

**Material:** PET  
**Medida:** 7.5 x 24.7 cm  
**Área de Impresión:** 3.8 x 5.8 cm  
**Técnica de Impresión:** Serigrafía / Tampografía  
**Colores:** A/B/H/R/V/Y / AS/BS/OS/RS/SS/VS/YS  
**Capacidad:** 700 ml

Peso 44 grs. sin tapa. Con válvula de seguridad.



R



A



SS



VS



AS



YS



BS



OS



RS

ANF 009

ÁNFORA SINKER



Comparativo ANF 009 con ANF 003

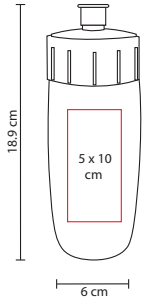

**Material:** PET  
**Medida:** 6 x 18.9 cm  
**Área de Impresión:** 5 x 10 cm  
**Técnica de Impresión:** Serigrafía /  
Tampografía  
**Colores:** A/B/H/N/O/R/V/Y  
AS/BS/OS/RS/SS/VS/YS  
**Capacidad:** 500 ml

Con válvula de seguridad.



O



YS



AS



N



BS



OS



VS



RS



SS



V



R



A



H



B



Y

ÁNFORAS



ANF 008

ÁNFORA KALI



M



V



Y



R



A



B



O

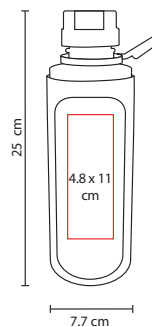

**Materia:** Plástico Tritan  
**Medida:** 7.7 x 25 cm  
**Área de Impresión:** 4.8 x 11 cm  
**Técnica de Impresión:** Serigrafía /  
 Tampografía  
**Colores:** A/B/M/O/R/V/Y  
**Capacidad:** 600 ml

Tapa de rosca, con gancho de plástico incluido.

ANF 011

ÁNFORA MAKI



R



A



V



O

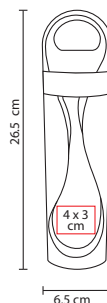

**Materia:** Plástico Tritan  
**Medida:** 6.5 x 26.5 cm  
**Área de Impresión:** 4 x 3 cm  
**Técnica de Impresión:** Serigrafía /  
 Tampografía  
**Colores:** A/O/R/V  
**Capacidad:** 500 ml

Tapa doble rosca con agarradera.



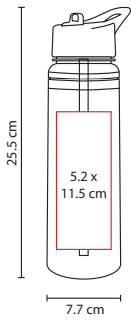

ANF 010

ÁNFORA MILO



P

**Material:** Plástico  
**Medida:** 7.7 x 25.5 cm  
**Área de Impresión:** 5.2 x 11.5 cm  
**Técnica de Impresión:** Serigrafía / Tampografía  
**Colores:** A/M/N/O/P/R/V/Y  
**Capacidad:** 610 ml

Doble Pared. Incluye válvula de seguridad y popote.



R



M



N

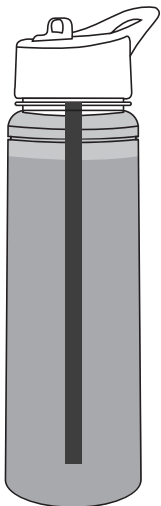

Y



O



V



A



TMF 07

TERMO CON PAPEL  
EASY-PRINT

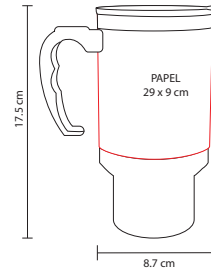

**Materia:** Acero Inoxidable  
**Medida:** 8.7 x 17.5 cm  
**Área de Impresión:** 29 x 9 cm  
**Técnica de Impresión:** Pantógrafo / Serigrafía  
**Colores:** Plata con Plástico Transparente  
**Capacidad:** 630 ml

Doble pared. Incluye papel para impresión.

TMPS 17

TERMO LIBERTY

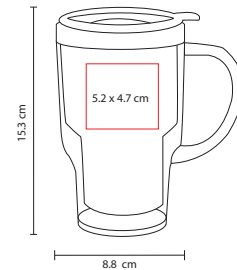

**Materia:** Acero Inoxidable / Plástico  
**Medida:** 8.8 x 15.3 cm  
**Área de Impresión:** 5.2 x 4.7 cm  
**Técnica de Impresión:** Serigrafía / Tampografía  
**Colores:** A/R/T  
**Capacidad:** 450 ml

Doble pared. Cubierta translúcida.

TMPS 18

TERMO HEAT CON  
USB

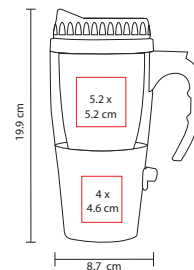

**Materia:** Acero Inoxidable / Plástico  
**Medida:** 8.7 x 19.9 cm  
**Área de Impresión:** 5.2 x 5.2 cm  
**Técnica de Impresión:** Serigrafía / Tampografía  
**Colores:** A/R/T  
**Capacidad:** 350 ml

Doble pared. Fuente corriente, adaptador para automóvil y USB, mantiene la temperatura de las bebidas, no calienta. Incluye válvula de seguridad.



TERMOS Y CILINDROS



### TMPS 300

CILINDRO CUIREL

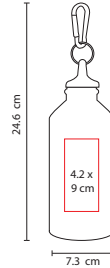

**Material:** Aluminio  
**Medida:** 7.3 x 24.6 cm  
**Área de Impresión:** 4.2 x 9 cm  
**Técnica de Impresión:** Láser / Serigrafía / Tampografía  
**Colores:** Gris Metálico  
**Capacidad:** 500 ml

Cilindro triangular. Incluye gancho.



### TMPS 400

MINI CILINDRO ALPES



Tamaños TMPS 400 y TMPS 101

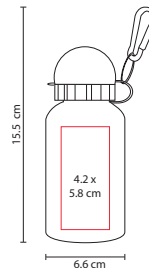

**Material:** Aluminio  
**Medida:** 6.6 x 15.5 cm  
**Área de Impresión:** 4.2 x 5.8 cm  
**Técnica de Impresión:** Láser / Serigrafía / Tampografía  
**Colores:** A/R/S  
**Capacidad:** 300 ml

Incluye gancho y válvula de seguridad.



### TMPS 101

CILINDRO INTERLAKEN

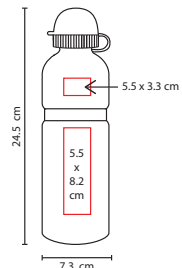

**Material:** Aluminio  
**Medida:** 7.3 x 24.5 cm  
**Área de Impresión:** 5.5 x 8.2 cm  
**Técnica de Impresión:** Láser / Serigrafía / Tampografía  
**Colores:** A/N/R/S  
**Capacidad:** 800 ml

Incluye válvula de seguridad.

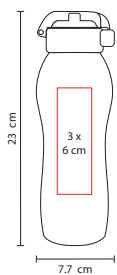

## TMPS 60

CILINDRO MOLTON



**Material:** Acero Inoxidable  
**Medida:** 7.7 x 23 cm  
**Área de Impresión:** 3 x 6 cm  
**Técnica de Impresión:** Láser / Tampografía  
**Colores:** A/N/R/S  
**Capacidad:** 650 ml

Incluye válvula de seguridad.



S A N R

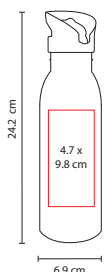

## TMPS 45

CILINDRO NAVY



**Material:** Acero Inoxidable  
**Medida:** 6.9 x 24.2 cm  
**Área de Impresión:** 4.7 x 9.8 cm  
**Técnica de Impresión:** Láser / Pantógrafo / Serigrafía / Tampografía  
**Colores:** A/N/R/S/V  
**Capacidad:** 700 ml

Incluye válvula de seguridad y popote.

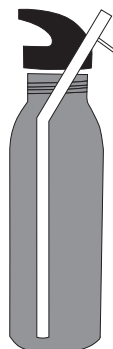

S A R N



V

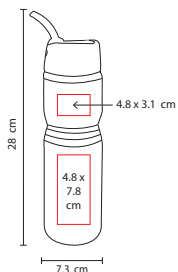

## TMPS 80

CILINDRO OWEN



**Material:** Aluminio  
**Medida:** 7.3 x 28 cm  
**Área de Impresión:** 4.8 x 7.8 cm  
**Técnica de Impresión:** Láser / Serigrafía  
**Colores:** A/N/O/R/S/V  
**Capacidad:** 860 ml

Cuenta con popote-gancho.

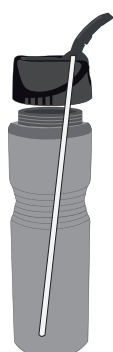

S R A N V



O



TT 02

TERMO LANE



Y



G



V



A



R

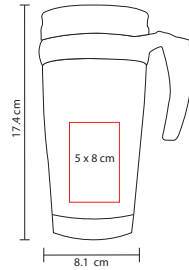

**Material:** Plástico  
**Medida:** 8,1 x 17,4 cm  
**Área de Impresión:** 5 x 8 cm  
**Técnica de Impresión:** Serigrafía /  
 Tampografía  
**Colores:** A/G/R/V/Y  
**Capacidad:** 400 ml

Doble pared. Interior térmico. Incluye válvula de seguridad.

TT 09

TERMO NOVA



A



N



V



Y



R

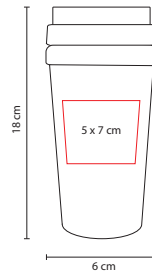

**Material:** Plástico  
**Medida:** 6 x 18 cm  
**Área de Impresión:** 5 x 7 cm  
**Técnica de Impresión:** Serigrafía /  
 Tampografía  
**Colores:** A/N/R/V/Y  
**Capacidad:** 450 ml

Incluye válvula de seguridad.

TMPS 24

VASO EMBASSY



R



B



V



A



O

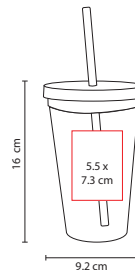
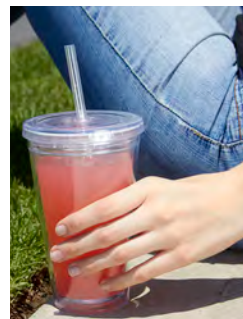

**Material:** Plástico  
**Medida:** 9,2 x 16 cm  
**Área de Impresión:** 5,5 x 7,3 cm  
**Técnica de Impresión:** Serigrafía /  
 Tampografía  
**Colores:** A/B/O/R/V  
**Capacidad:** 500 ml

Doble pared, con popote incluido.

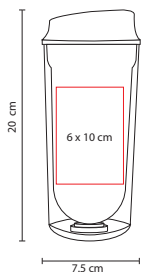

**Material:** Plástico  
**Medida:** 7.5 x 20 cm  
**Área de Impresión:** 6 x 10 cm  
**Técnica de Impresión:** Serigrafía / Tampografía  
**Colores:** A/B/M/O/R/V  
**Capacidad:** 500 ml

Doble pared. Incluye válvula de seguridad.



## TMPS 27

VASO LOGAM

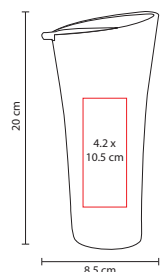

**Material:** Plástico  
**Medida:** 8.5 x 20 cm  
**Área de Impresión:** 4.2 x 10.5 cm  
**Técnica de Impresión:** Serigrafía / Tampografía  
**Colores:** A/B/N/O/R/V  
**Capacidad:** 530 ml

Doble pared. Con tapa de presión e interior en color negro.



## TMPS 11

TERMO SPACE

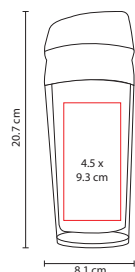

**Material:** Plástico  
**Medida:** 8.1 x 20.7 cm  
**Área de Impresión:** 4.5 x 9.3 cm  
**Técnica de Impresión:** Serigrafía / Tampografía  
**Colores:** A/N/O/R/V/Y  
**Capacidad:** 450 ml

Doble pared. Con válvula especial para abrir y cerrar.



## TMPS 13

TERMO SKY



TMPS 23

TERMO BANGKOK



R



T



N



A

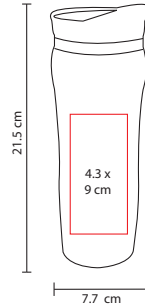

**Materia:** Acero Inoxidable / Plástico  
**Medida:** 7.7 x 21.5 cm  
**Área de Impresión:** 4.3 x 9 cm  
**Técnica de Impresión:** Serigrafía / Tampografía  
**Colores:** A/N/R/T  
**Capacidad:** 480 ml

Doble pared. Incluye válvula de seguridad.

TMPS 31

TERMO BAKU



V



O



Y



R



A

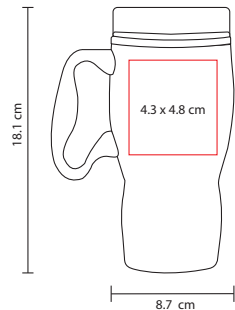

**Materia:** Acero Inoxidable / Plástico  
**Medida:** 8.7 x 18.1 cm  
**Área de Impresión:** 4.3 x 4.8 cm  
**Técnica de Impresión:** Serigrafía / Tampografía  
**Colores:** A/O/R/V/Y  
**Capacidad:** 500 ml

Doble pared. Incluye válvula de seguridad.





## TMPS 85

TERMO SEVIER



V



A

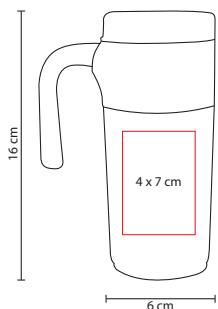

**Material:** Acero Inoxidable / Plástico  
**Medida:** 6 x 16 cm  
**Área de Impresión:** 4 x 7 cm  
**Técnica de Impresión:** Láser / Pantógrafo / Serigrafía / Tampografía  
**Colores:** A/B/N/R/V  
**Capacidad:** 325 ml



N



B



R

Doble pared. Incluye válvula de seguridad.



## TMPS 65

TERMO LANKA



B



O

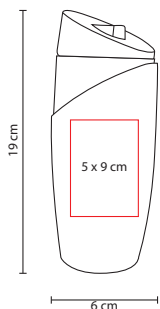

**Material:** Plástico / Acero Inoxidable  
**Medida:** 6 x 19 cm  
**Área de Impresión:** 5 x 9 cm  
**Técnica de Impresión:** Serigrafía / Tampografía  
**Colores:** A/B/O/R  
**Capacidad:** 350 ml



R



A

Doble pared. Incluye válvula de seguridad.

TMPS 16

TERMO TRAVEL MUG

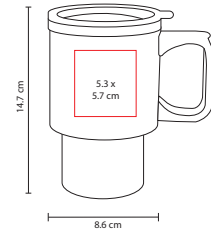

**Material:** Acero Inoxidable  
**Medida:** 8.6 x 14.7 cm  
**Área de Impresión:** 5.3 x 5.7 cm  
**Técnica de Impresión:** Pantógrafo / Serigrafía / Tampografía  
**Colores:** Plata  
**Capacidad:** 400 ml

Doble pared. Incluye válvula de seguridad.

TMPS 30

TERMO THUNDER

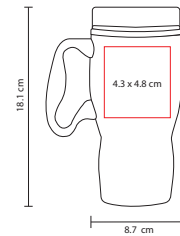

**Material:** Acero Inoxidable / Plástico  
**Medida:** 8.7 x 18.1 cm  
**Área de Impresión:** 4.3 x 4.8 cm  
**Técnica de Impresión:** Pantógrafo / Serigrafía / Tampografía  
**Colores:** Plata  
**Capacidad:** 500 ml

Doble pared. Incluye válvula de seguridad.

TMPS 19

TERMO TURBO COFFEE

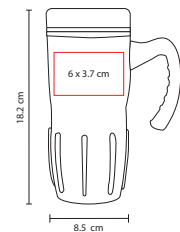

**Material:** Acero Inoxidable / Plástico  
**Medida:** 8.5 x 18.2 cm  
**Área de Impresión:** 6 x 3.7 cm  
**Técnica de Impresión:** Pantógrafo / Serigrafía / Tampografía  
**Colores:** Plata  
**Capacidad:** 500 ml

Doble pared. Con barras antideslizantes y válvula de seguridad.

TMPS 90

TERMO VINSON

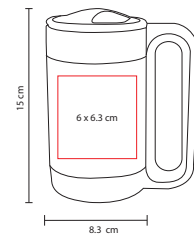

**Material:** Acero Inoxidable / Plástico  
**Medida:** 8.3 x 15 cm  
**Área de Impresión:** 6 x 6.3 cm  
**Técnica de Impresión:** Láser / Serigrafía  
**Colores:** Gris Metálico  
**Capacidad:** 500 ml

Doble pared. Asa de plástico.

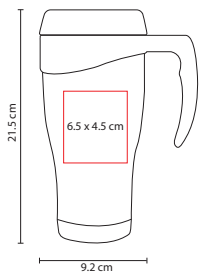

## TMPS 29

TERMO ARES



**Material:** Acero Inoxidable / Plástico  
**Medida:** 9.2 x 21.5 cm  
**Área de Impresión:** 6.5 x 4.5 cm  
**Técnica de Impresión:** Pantógrafo / Serigrafía / Tampografía  
**Colores:** Gris Oxford  
**Capacidad:** 740 ml

Doble pared. Incluye válvula de seguridad.

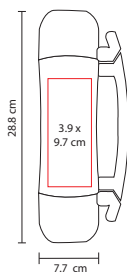

## TMPS 15

TERMO DUBLÍN



**Material:** Acero Inoxidable  
**Medida:** 7.7 x 28.8 cm  
**Área de Impresión:** 3.9 x 9.7 cm  
**Técnica de Impresión:** Pantógrafo / Serigrafía  
**Colores:** Plata  
**Capacidad:** 600 ml

Doble pared. Asa de plástico. Incluye dos tazas metálicas.

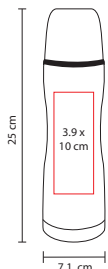

## TMF 06

TERMO SILHOUETTE



**Material:** Acero Inoxidable  
**Medida:** 7.1 x 25 cm  
**Área de Impresión:** 3.9 x 10 cm  
**Técnica de Impresión:** Láser / Serigrafía / Tampografía  
**Colores:** Gris Oxford Metalizado  
**Capacidad:** 500 ml

Doble pared. Incluye válvula de seguridad.

DAM 702

ESPEJO CON LUZ AVANTE

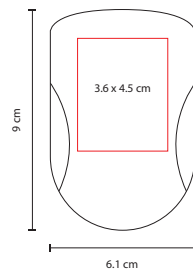

**Material:** Plástico  
**Medida:** 6.1 x 9 cm  
**Área de Impresión:** 3.6 x 4.5 cm  
**Técnica de Impresión:** Serigrafía  
**Colores:** Blanco

Luz de 1 LED. Tapa deslizable.

DAM 112

ESPEJO ECLIPSE

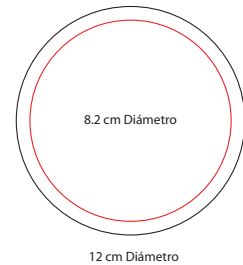

**Material:** Plástico  
**Medida:** 12 cm Diámetro  
**Área de Impresión:** 8.2 cm Diámetro  
**Técnica de Impresión:** Serigrafía  
**Colores:** Humo

Espejo normal y de aumento. No incluye labial.

DAM 701

ESPEJO PORTARRETRATO EGO

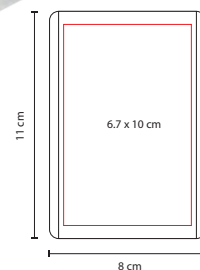

**Material:** Plástico  
**Medida:** 8 x 11 cm  
**Área de Impresión:** 6.7 x 10 cm  
**Técnica de Impresión:** Serigrafía  
**Colores:** A/O/R/V

Incluye espacio para fotografía.



DAM 560

ESPEJO FANCY



**Material:** Plástico  
**Medida:** 6 cm Diámetro  
**Área de Impresión:** 5 cm Diámetro  
**Técnica de Impresión:** Serigrafía  
**Colores:** Plata

No incluye aplicador.

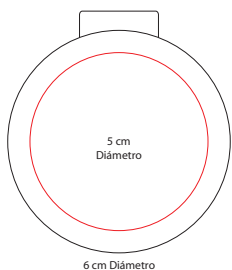

DAM 2123

ESPEJO SLASH



**Material:** Plástico  
**Medida:** 6.9 x 7.9 cm  
**Área de Impresión:** 4.5 x 5 cm  
**Técnica de Impresión:** Serigrafía  
**Colores:** Translúcido

No incluye brocha.

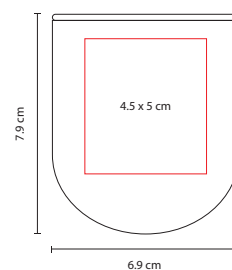

PRO 032

ESPEJO VERA



**Material:** Plástico  
**Medida:** 5.4 x 8.5 cm  
**Área de Impresión:** 3.5 x 6 cm  
**Técnica de Impresión:** Serigrafía  
**Colores:** Plata

No incluye brocha.

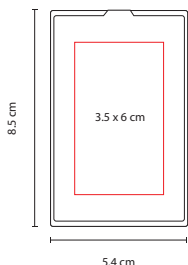

DAM 804

ESPEJO DOLLY



**Material:** Plástico  
**Medida:** 7 x 7 cm  
**Área de Impresión:** 5.5 x 5.5 cm  
**Técnica de Impresión:** Serigrafía  
**Colores:** Blanco

Incluye peine.

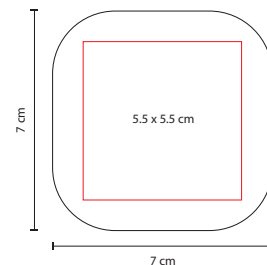

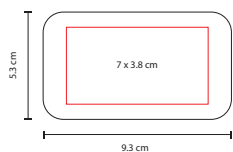

**Material:** Plástico  
**Medida:** 9.3 x 5.3 cm  
**Área de Impresión:** 7 x 3.8 cm  
**Técnica de Impresión:** Serigrafía  
**Colores:** Blanco

Incluye espejo y lima de uñas.



## DAM 440

ESPEJO ATTITUD

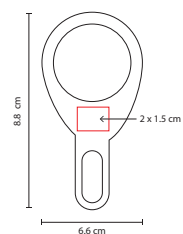

**Material:** Plástico  
**Medida:** 6.6 x 8.8 cm  
**Área de Impresión:** 2 x 1.5 cm  
**Técnica de Impresión:** Serigrafía  
**Colores:** Blanco

Cepillo con espejo. Incluye 1 lima de uñas y 1 pulidor.



## DAM 600

CEPILLO CHERRY

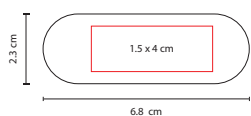

**Material:** Plástico  
**Medida:** 6.8 x 2.3 cm  
**Área de Impresión:** 1.5 x 4 cm  
**Técnica de Impresión:** Serigrafía  
**Colores:** Blanco

Incluye 2 limas de uñas y 2 pulidores.



## DAM 438

LIMA ARALIA

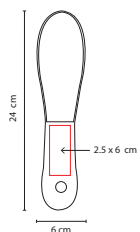

**Material:** Plástico  
**Medida:** 6 x 24 cm  
**Área de Impresión:** 2.5 x 6 cm  
**Técnica de Impresión:** Serigrafía  
**Colores:** Blanco

Lima para pies.



## DAM 436

LIMA FEET CLEAN



### DAM 570

SET DE BROCHAS  
CRYSTAL FACE

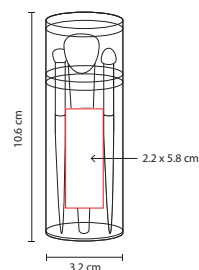

**Material:** Plástico  
**Medida:** 3.2 x 10.6 cm  
**Área de Impresión:** 2.2 x 5.8 cm  
**Técnica de Impresión:** Serigrafía  
**Colores:** Transparente

Incluye 5 accesorios.

### DAM 530

SET DE BROCHAS Y  
ESPEJO DONNA

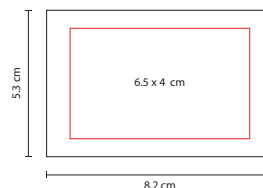

**Material:** Plástico  
**Medida:** 8.2 x 5.3 cm  
**Área de Impresión:** 6.5 x 4 cm  
**Técnica de Impresión:** Serigrafía  
**Colores:** Transparente

Incluye 5 accesorios y espejo.

### DAM 435

SET DE MANICURE  
FUNKY



V



A



Y



B



R

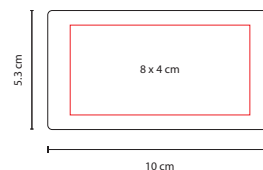

**Material:** Plástico  
**Medida:** 10 x 5.3 cm  
**Área de Impresión:** 8 x 4 cm  
**Técnica de Impresión:** Serigrafía  
**Colores:** A/B/R/V/Y

Incluye 4 accesorios.





## DAM 870

SET DE BROCHAS  
BLACK SHADOW

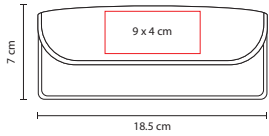

**Material:** PU / Plástico  
**Medida:** 18.5 x 7 cm  
**Área de Impresión:** 9 x 4 cm  
**Técnica de Impresión:** Serigrafía  
**Colores:** Negro

Incluye 4 accesorios.

## DAM 773

SET DE MANICURE Y  
BROCHAS YOUNG

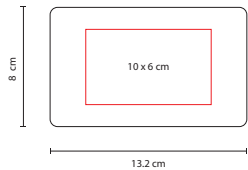

**Material:** Curpiel  
**Medida:** 13.2 x 8 cm  
**Área de Impresión:** 10 x 6 cm  
**Técnica de Impresión:** Grabado / Serigrafía  
**Colores:** Negro

Incluye 10 accesorios (5 brochas, 5 accesorios para manicure y un espejo).

## DAM 540

SET DE BROCHAS  
GLAMOUR

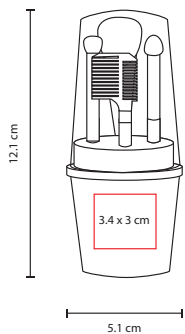

**Material:** Plástico  
**Medida:** 5.1 x 12.1 cm  
**Área de Impresión:** 3.4 x 3 cm  
**Técnica de Impresión:** Serigrafía / Tampografía  
**Colores:** Plata

Incluye 5 accesorios.

DAM 699

SET DE MANICURE  
DECO

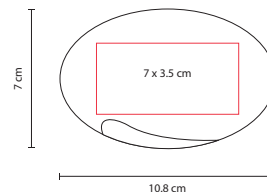

**Material:** Metal / Plástico  
**Medida:** 10.8 x 7 cm  
**Área de Impresión:** 7 x 3.5 cm  
**Técnica de Impresión:** Serigrafía / Tampografía  
**Colores:** Blanco

Incluye 4 accesorios y espejo.

DAM 860

SET DE MANICURE  
FRENCH NAIL

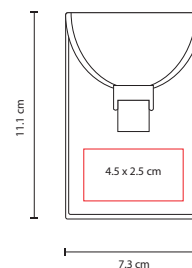

**Material:** Curpiel  
**Medida:** 7.3 x 11.1 cm  
**Área de Impresión:** 4.5 x 2.5 cm  
**Técnica de Impresión:** Serigrafía  
**Colores:** Negro

Incluye 4 accesorios y espejo.

DAM 0401

SET DE MANICURE  
BALAK

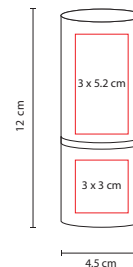

**Material:** Aluminio  
**Medida:** 4.5 x 12 cm  
**Área de Impresión:** 3 x 3 cm Base / 3 x 5.2 cm Tapa  
**Técnica de Impresión:** Serigrafía / Tampografía  
**Colores:** Plata

Incluye 4 accesorios.

## DAM 5120

ALHAJERO BONNY

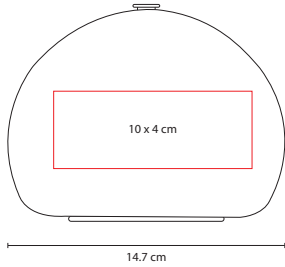

**Material:** Curpiel  
**Medida:** 14.7 x 4.7 cm  
**Área de Impresión:** 10 x 4 cm  
**Técnica de Impresión:** Serigrafía  
**Colores:** Negro

No incluye alhajas.

## DAM 5140

ALHAJERO QUEEN

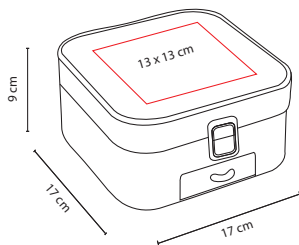

**Material:** Curpiel / Terciopelo  
**Medida:** 17 x 9 cm  
**Área de Impresión:** 13 x 13 cm  
**Técnica de Impresión:** Serigrafía  
**Colores:** Negro

Incluye espejo. No incluye alhajas.



## DAM 925

COSTURERO CON  
TIJERAS CAIMÁN



**Material:** Plástico  
**Medida:** 7 x 2,6 cm  
**Área de Impresión:** 4,7 x 1,5 cm  
**Técnica de Impresión:** Serigrafía  
**Colores:** Blanco Frosty

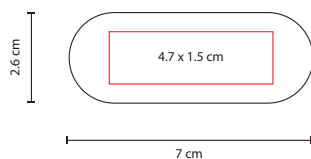

Incluye botones, hilo y un seguro.

## DAM 810

COSTURERO  
OVALADO AURA



**Material:** Plástico  
**Medida:** 7,7 x 5,4 cm  
**Área de Impresión:** 4,5 x 3,5 cm  
**Técnica de Impresión:** Serigrafía  
**Colores:** Blanco Frosty

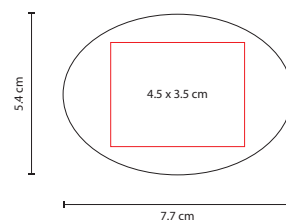

Incluye 4 accesorios.

## U 1071

COSTURERO CON  
ESPEJO BELLAMY



**Material:** Plástico  
**Medida:** 11,5 x 6,3 cm  
**Área de Impresión:** 9 x 4 cm  
**Técnica de Impresión:** Serigrafía  
**Colores:** Blanco

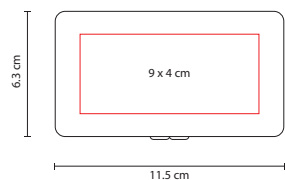

Incluye 9 accesorios.

## DAM 349

COSTURERO - PASTILLERO



**Material:** Plástico  
**Medida:** 9 x 2,2 cm  
**Área de Impresión:** 6,5 x 4,5 cm  
**Técnica de Impresión:** Serigrafía  
**Colores:** Blanco Frosty

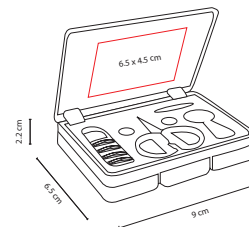

3 Compartimentos para pastillas, 1 compartimento costurero.

## DAM 502

COSMETIQUERA  
VICTORIAS



P



G



N

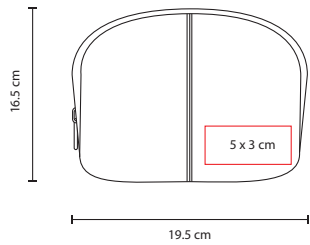

**Material:** Microfibra  
**Medida:** 19,5 x 16,5 cm  
**Área de Impresión:** 5 x 3 cm  
**Técnica de Impresión:** Bordado / Serigrafía  
**Colores:** G/N/P

## DAM 501

COSMETIQUERA  
PLATINUM



G



P



N

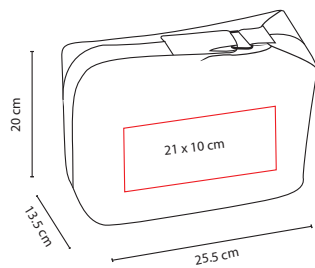

**Material:** Microfibra  
**Medida:** 25,5 x 20 cm  
**Área de Impresión:** 21 x 10 cm  
**Técnica de Impresión:** Bordado / Serigrafía  
**Colores:** G/N/P

Con 3 compartimentos internos.

DAM 437

PERFILADOR NOSE  
CLEAN

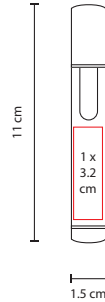

**Material:** Aluminio  
**Medida:** 1.5 x 11 cm  
**Área de Impresión:** 1 x 3.2 cm  
**Técnica de Impresión:** Pantógrafo / Serigrafía  
**Colores:** Plata

DAM 505

BATH BODY

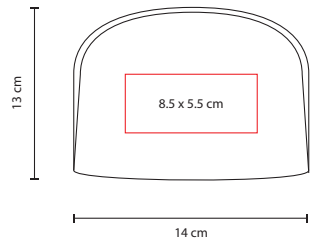

**Material:** Plástico / Madera  
**Medida:** 14 x 13 cm  
**Área de Impresión:** 8.5 x 5.5 cm  
**Técnica de Impresión:** Serigrafía  
**Colores:** Transparente

Incluye esponja, 1 estropajo y 2 cepillos.





R

### SH 1145

BOLÍGRAFO  
ATOMIZADOR  
ANTIBACTERIAL



A



B

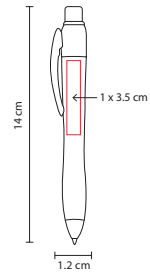

**Material:** Plástico  
**Medida:** 1.2 x 14 cm  
**Área de Impresión:** 1 x 3.5 cm  
**Técnica de Impresión:** Serigrafía  
**Colores:** A/B/R  
**Tinta:** Negra

Compartimento para gel antibacterial recargable. Incluye atomizador. Mecanismo twist.

### ANT 001

TARJETA  
ANTIBACTERIAL CON  
ATOMIZADOR

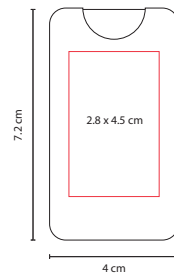

**Material:** Plástico  
**Medida:** 4 x 7.2 cm  
**Área de Impresión:** 2.8 x 4.5 cm  
**Técnica de Impresión:** Serigrafía  
**Colores:** Blanco

Aroma a limón. Incluye líquido antibacterial de 9 ml con atomizador.

### SLD 008

GEL ANTIBACTERIAL  
HELDER



A



R



B

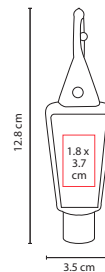

**Material:** Plástico / Silicón  
**Medida:** 3.5 x 12.8 cm  
**Área de Impresión:** 1.8 x 3.7 cm  
**Técnica de Impresión:** Serigrafía /  
Tampografía  
**Colores:** A/B/R

Portátil y recargable. Incluye sujetador de silicón.  
30 ml de gel antibacterial.



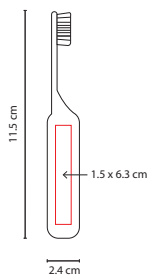

### SLD 003

CEPILLO PORTÁTIL  
MINT



**Material:** Plástico  
**Medida:** 2.4 x 11.5 cm  
**Área de Impresión:** 1.5 x 6.3 cm  
**Técnica de Impresión:** Serigrafía  
**Colores:** Transparente

Cepillo portátil. Estuche en la base del cepillo.



### MNT 001

MENTAS FRESH

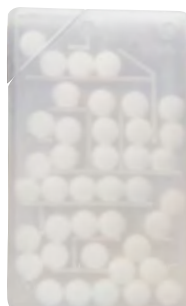
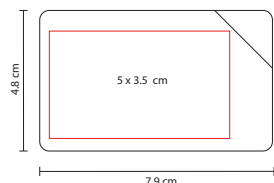

**Material:** Plástico  
**Medida:** 7.9 x 4.8 cm  
**Área de Impresión:** 5 x 3.5 cm  
**Técnica de Impresión:** Serigrafía  
**Colores:** A/B/R  
**Capacidad:** 6.5 grs.

Contiene 6.5 grs. en pastillas de menta. Estuche con laberinto interior.

A

B

R

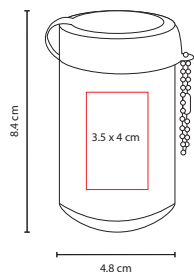

### SLD 002

TOALLITAS SALVA



A



B



R



V

**Material:** Plástico  
**Medida:** 4.8 x 8.4 cm  
**Área de Impresión:** 3.5 x 4 cm  
**Técnica de Impresión:** Tampografía  
**Colores:** A/B/R/V

Contiene 30 toallitas húmedas. Incluye cadena metálica.

KIT 911

KIT ANTIBACTERIAL

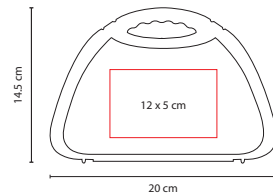

**Material:** Plástico  
**Medida:** 20 x 14.5 cm  
**Área de Impresión:** 12 x 5 cm  
**Técnica de Impresión:** Serigrafía  
**Colores:** Blanco Frosty

Incluye gel antibacterial de 60 ml., 1 cubrebocas, 2 gasas, 3 curitas, 20 cotonetes y 1 mertodol rojo de 40 ml.  
 Incluye estuche de plástico.

SLD 006

CINTA MASA CORPORAL SLIM

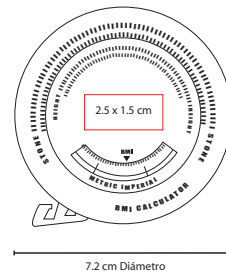
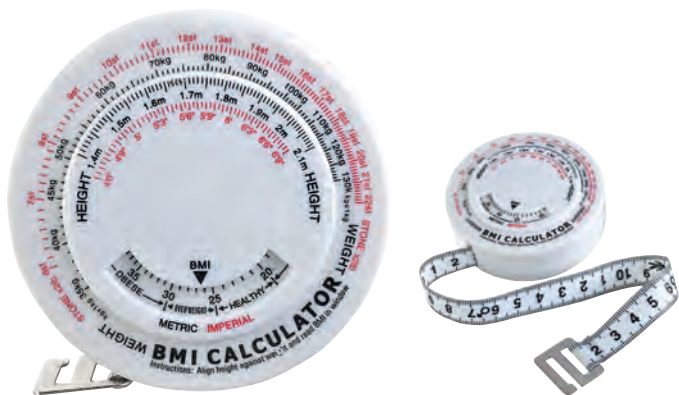

**Material:** Plástico  
**Medida:** 7.2 cm Diámetro  
**Área de Impresión:** 2.5 x 1.5 cm  
**Técnica de Impresión:** Serigrafía  
**Colores:** Blanco

Cinta medidora de masa corporal. 150 cm de longitud.

SLD 007

BÁSCULA DIGITAL ESVELTY

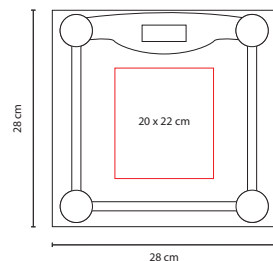

**Material:** Cristal  
**Medida:** 28 x 28 cm  
**Área de Impresión:** 20 x 22 cm  
**Técnica de Impresión:** Serigrafía  
**Colores:** Gris

Incluye 2 baterías AA. Capacidad máxima 180 kg.



PT 200

PASTILLERO AMBAÍ

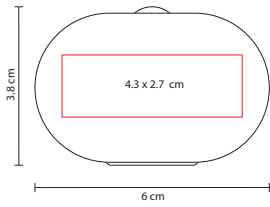

**Material:** Plástico  
**Medida:** 6 x 3.8 cm  
**Área de Impresión:** 4.3 x 2.7 cm  
**Técnica de Impresión:** Serigrafía  
**Colores:** Blanco Frosty

3 Compartimentos.



PT 0942

PASTILLERO FROSTY

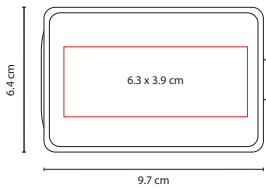

**Material:** Plástico  
**Medida:** 9.7 x 6.4 cm  
**Área de Impresión:** 6.3 x 3.9 cm  
**Técnica de Impresión:** Serigrafía  
**Colores:** Blanco Frosty

10 Compartimentos.

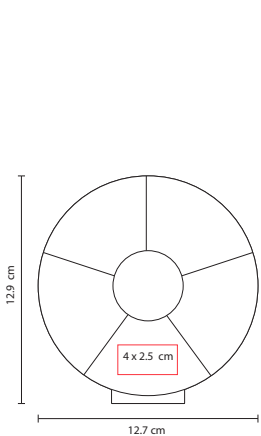

PT 300

PASTILLERO DENNIS

**Material:** Plástico  
**Medida:** 12.7 x 12.9 cm  
**Área de Impresión:** 4 x 2.5 cm  
**Técnica de Impresión:** Serigrafía  
**Colores:** A/B/R

5 Compartimentos.



R



B

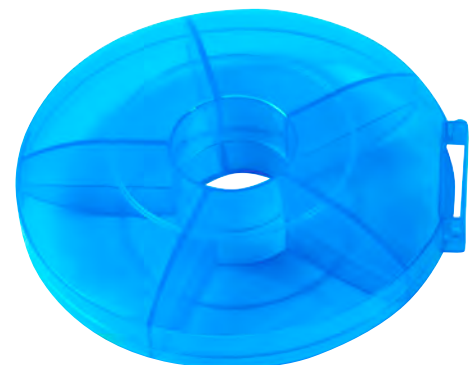

A



**PT 3012**  
PASTILLERO LLAVERO  
DAKAR

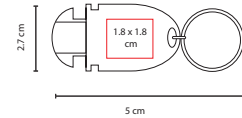

**Material:** Plástico  
**Medida:** 5 x 2.7 cm  
**Área de Impresión:** 1.8 x 1.8 cm  
**Técnica de Impresión:** Serigrafía  
**Colores:** Blanco

1 Compartimento.



A



R



B

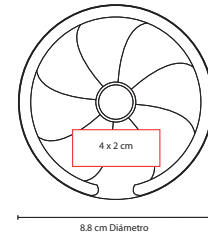

**Material:** Plástico  
**Medida:** 8.8 cm Diámetro  
**Área de Impresión:** 4 x 2 cm  
**Técnica de Impresión:** Tampografía  
**Colores:** A/B/R

7 Compartimentos. Sistema giratorio.



**PT 2167**  
PASTILLERO SAO

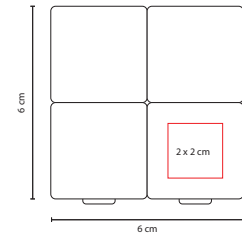

**Material:** Plástico  
**Medida:** 6 x 6 cm  
**Área de Impresión:** 2 x 2 cm  
**Técnica de Impresión:** Serigrafía  
**Colores:** Blanco Frosty

4 Compartimentos.



**PT 588**  
VASO PASTILLERO

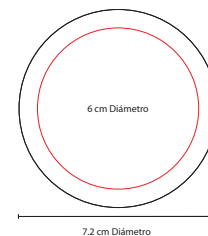
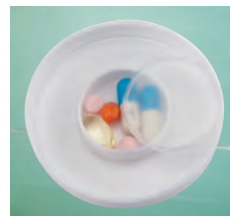

**Material:** Plástico  
**Medida:** 7.2 cm Diámetro  
**Área de Impresión:** 6 cm Diámetro  
**Técnica de Impresión:** Serigrafía  
**Colores:** Blanco con Transparente

Pastillero con tapa y vaso retráctil.

## PT 2166

### PASTILLERO DELTA

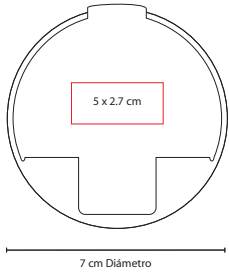

**Material:** Plástico  
**Medida:** 7 cm Diámetro  
**Área de Impresión:** 5 x 2.7 cm  
**Técnica de Impresión:** Serigrafía  
**Colores:** A/B/R

4 Compartimentos.



## PT 100

### PASTILLERO GAMMA

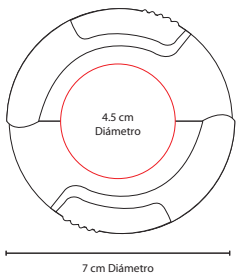

**Material:** Plástico  
**Medida:** 7 cm Diámetro  
**Área de Impresión:** 4.5 cm Diámetro  
**Técnica de Impresión:** Serigrafía  
**Colores:** A/N/R

2 Compartimentos.



## PT 2362

### PASTILLERO MENZEL

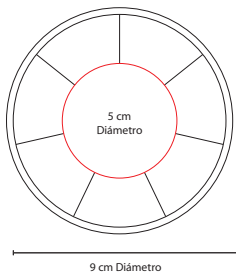

**Material:** Plástico  
**Medida:** 9 cm Diámetro  
**Área de Impresión:** 5 cm Diámetro  
**Técnica de Impresión:** Serigrafía /  
Tampografía  
**Colores:** Blanco Frosty

7 Compartimentos para cada día de la semana.





PT 2164

PASTILLERO  
JANS CON CORTA  
PASTILLAS

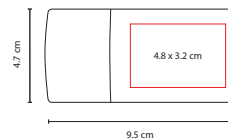

**Material:** Plástico  
**Medida:** 9.5 x 4.7 cm  
**Área de Impresión:** 4.8 x 3.2 cm  
**Técnica de Impresión:** Serigrafía  
**Colores:** Blanco

Corta pastillas y 2 compartimentos separables.



PT 2100

PASTILLERO CON  
CORTA PASTILLAS  
CRYSTAL

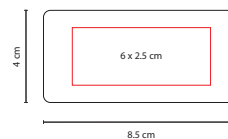

**Material:** Plástico  
**Medida:** 8.5 x 4 cm  
**Área de Impresión:** 6 x 2.5 cm  
**Técnica de Impresión:** Serigrafía  
**Colores:** Blanco con Transparente

Con corta pastillas.



SOC 011-09

CORAZÓN  
ANTI-STRESS

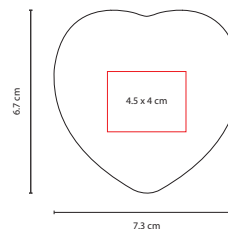

**Material:** PU  
**Medida:** 7.3 x 6.7 cm  
**Área de Impresión:** 4.5 x 4 cm  
**Técnica de Impresión:** Tampografía  
**Colores:** Rojo

SOC 011-07

CARITA FELIZ  
ANTI-STRESS

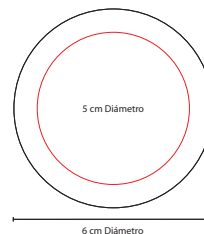
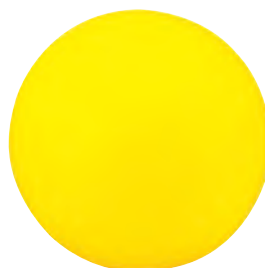

**Material:** PU  
**Medida:** 6 cm Diámetro  
**Área de Impresión:** 5 cm Diámetro  
**Técnica de Impresión:** Tampografía  
**Colores:** Amarillo



BALÍN RELAJADOR



MASAJEADOR



ANTI-STRESS

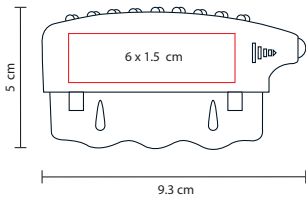

**Material:** Plástico  
**Medida:** 9.3 x 5 cm  
**Área de Impresión:** 6 x 1.5 cm  
**Técnica de Impresión:** Serigrafía  
**Colores:** A/B/R

Anti-stress, masajeador y balón relajador.



A



R

## PRO 600

MASAJEADOR GALIO



B

## SOC 013

PELOTA LISA  
 ANTI-STRESS



Y

O

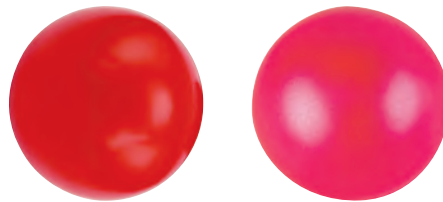

R

RM

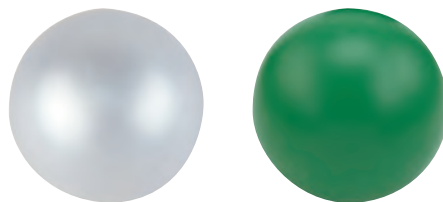

S

V

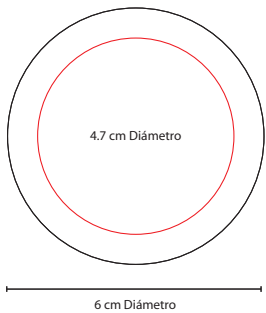

**Material:** PU  
**Medida:** 6 cm Diámetro  
**Área de Impresión:** 4.7 cm Diámetro  
**Técnica de Impresión:** Tampografía  
**Colores:** A/O/R/RM/S/V/Y



A

SOC 023

CASA ANTI-STRESS

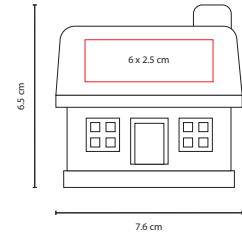

**Material:** PU  
**Medida:** 7.6 x 6.5 cm  
**Área de Impresión:** 6 x 2.5 cm  
**Técnica de Impresión:** Serigrafía  
**Colores:** Blanco con Gris y Rojo

SOC 024

TRAILER ANTI-STRESS

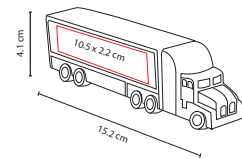

**Material:** PU  
**Medida:** 15.2 x 4.1 cm  
**Área de Impresión:** 10.5 x 2.2 cm  
**Técnica de Impresión:** Serigrafía  
**Colores:** Blanco con Gris

SOC 027

PUERQUITO ANTI-STRESS

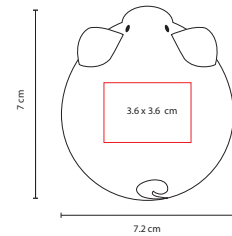

**Material:** PU  
**Medida:** 7.2 x 7 cm  
**Área de Impresión:** 3.6 x 3.6 cm  
**Técnica de Impresión:** Tampografía  
**Colores:** Rosa

SOC 026

VAQUITA ANTI-STRESS

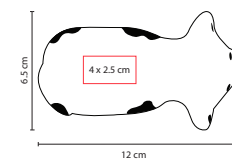

**Material:** PU  
**Medida:** 12 x 6.5 cm  
**Área de Impresión:** 4 x 2.5 cm  
**Técnica de Impresión:** Tampografía  
**Colores:** Blanco con Negro





## SOC 028

ANTI-STRESS WIT

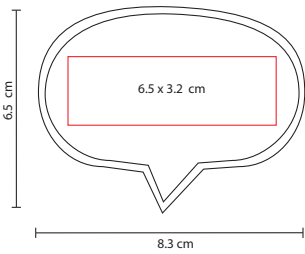

**Material:** PU  
**Medida:** 8.3 x 6.5 cm  
**Área de Impresión:** 6.5 x 3.2 cm  
**Técnica de Impresión:** Serigrafía  
**Colores:** Blanco con Negro

Anti-stress en forma de globo de idea.

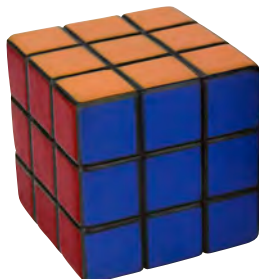
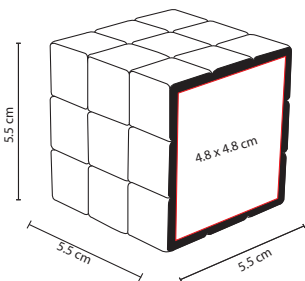

## SOC 029

CUBO ANTI-STRESS

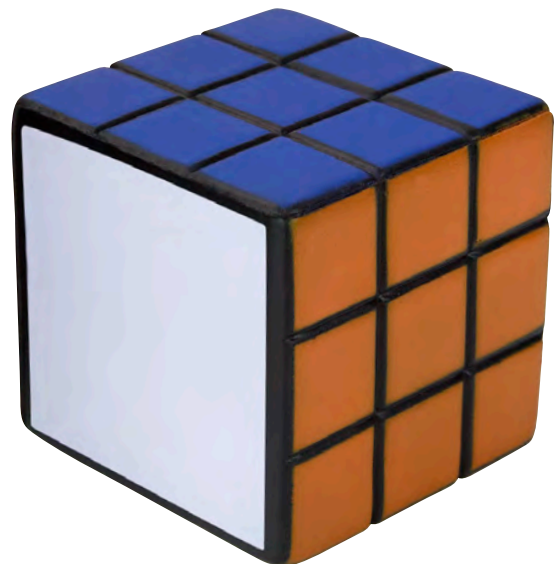

**Material:** PU  
**Medida:** 5.5 x 5.5 cm  
**Área de Impresión:** 4.8 x 4.8 cm  
**Técnica de Impresión:** Serigrafía  
**Colores:** Blanco y 5 Colores

5 Caras de color y una cara blanca para impresión.

## SOC 013 W

MUNDO ANTI-STRESS

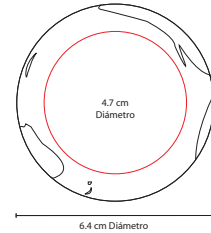

**Material:** PU  
**Medida:** 6.4 cm Diámetro  
**Área de Impresión:** 4.7 cm Diámetro  
**Técnica de Impresión:** Tampografía  
**Colores:** Azul con Verde

## SOC 011-06

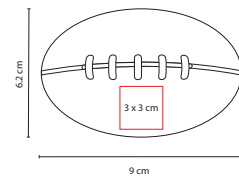
PELOTA ANTI-STRESS  
FUTBOL AMERICANO

**Material:** PU  
**Medida:** 9 x 6.2 cm  
**Área de Impresión:** 3 x 3 cm  
**Técnica de Impresión:** Tampografía  
**Colores:** Café

## SOC 011-03

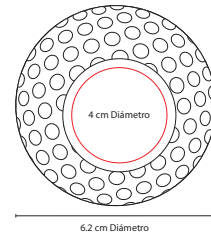
PELOTA ANTI-STRESS  
GOLF

**Material:** PU  
**Medida:** 6.2 cm Diámetro  
**Área de Impresión:** 4 cm Diámetro  
**Técnica de Impresión:** Tampografía  
**Colores:** Blanco

## SOC 011-04

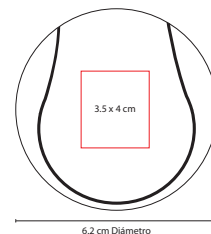
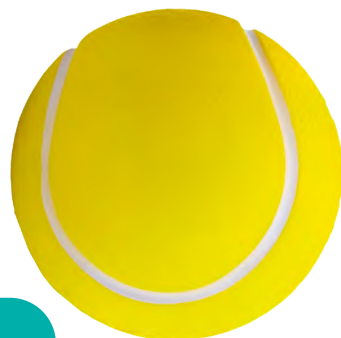
PELOTA ANTI-STRESS  
TENNIS

**Material:** PU  
**Medida:** 6.2 cm Diámetro  
**Área de Impresión:** 3.5 x 4 cm  
**Técnica de Impresión:** Tampografía  
**Colores:** Amarillo con Blanco

## SOC 011-01

PELOTA ANTI-STRESS  
FUTBOL

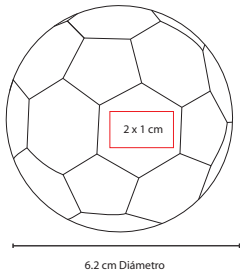

**Material:** PU  
**Medida:** 6.2 cm Diámetro  
**Área de Impresión:** 2 x 1 cm  
**Técnica de Impresión:** Tampografía  
**Colores:** Blanco con Negro



## SOC 011-02

PELOTA ANTI-STRESS  
BASKETBALL

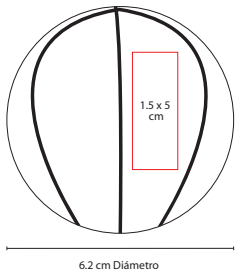

**Material:** PU  
**Medida:** 6.2 cm Diámetro  
**Área de Impresión:** 1.5 x 5 cm  
**Técnica de Impresión:** Tampografía  
**Colores:** Naranja con Negro



## SOC 011-05

PELOTA ANTI-STRESS  
BASEBALL

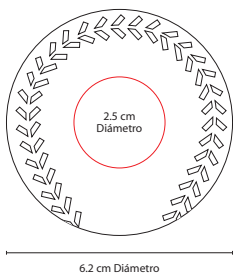

**Material:** PU  
**Medida:** 6.2 cm Diámetro  
**Área de Impresión:** 2.5 cm Diámetro  
**Técnica de Impresión:** Tampografía  
**Colores:** Blanco con Rojo



INF 015

PELOTA DE PLAYA



B



N

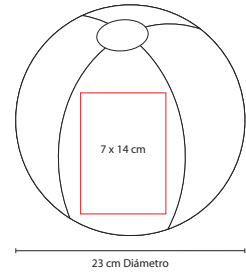

**Material:** Plástico  
**Medida:** 23 cm Diámetro  
**Área de Impresión:** 7 x 14 cm  
**Técnica de Impresión:** Serigrafía  
**Colores:** B/N

SOC 022

SPONGE SOCCER BALL



N



A



R

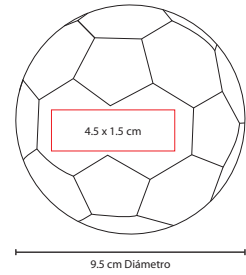

**Material:** Fibra de Poliéster / PVC  
**Medida:** 9.5 cm Diámetro  
**Área de Impresión:** 4.5 x 1.5 cm  
**Técnica de Impresión:** Serigrafía  
**Colores:** A/N/R

INF 080

FRISBEE PLEGABLE



V

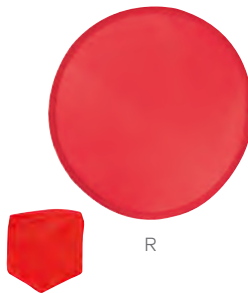

R



Y



A



O



**Material:** Nylon  
**Medida:** 25 cm Diámetro  
**Área de Impresión:** 22 cm Diámetro  
**Técnica de Impresión:** Serigrafía  
**Colores:** A/O/R/V/Y

Incluye funda.



GM 010

CUBO RUBBICK

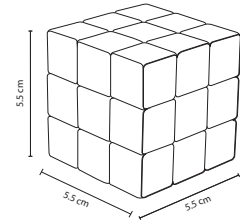

**Material:** Plástico  
**Medida:** 5.5 x 5.5 cm  
**Área de Impresión:** 5.5 x 5.5 cm  
**Técnica de Impresión:** Impresión Digital / Serigrafía  
**Colores:** Blanco

Incluye caja individual.

GM 020

MINI TRAILER HIGHWAY

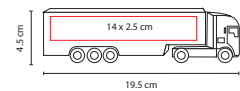
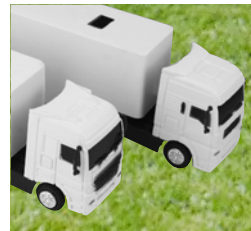

**Material:** Plástico  
**Medida:** 19.5 x 4.5 cm  
**Área de Impresión:** 14 x 2.5 cm  
**Técnica de Impresión:** Serigrafía  
**Colores:** Blanco

2 Modelos distintos surtidos al azar.

FREE 005

FRISBEE CONTOUR

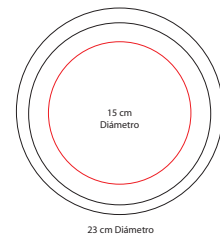

**Material:** Plástico  
**Medida:** 23 cm Diámetro  
**Área de Impresión:** 15 cm Diámetro  
**Técnica de Impresión:** Serigrafía  
**Colores:** A/B/R/V/Y

Y

A

B

R

V

GM 080

RAQUETAS TAMBOR

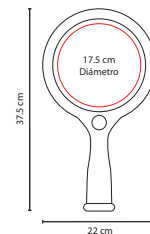

**Material:** Plástico  
**Medida:** 22 x 37.5 cm  
**Área de Impresión:** 17.5 cm Diámetro  
**Técnica de Impresión:** Serigrafía  
**Colores:** Blanco

Incluye pelota.



## GM 040

OSO TEDDY BEAR

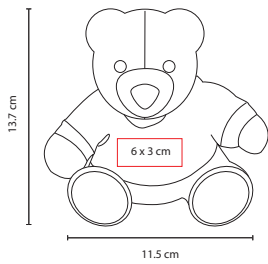

**Material:** Peluche  
**Medida:** 11,5 x 13,7 cm  
**Área de Impresión:** 6 x 3 cm  
**Técnica de Impresión:** Serigrafía  
**Colores:** A/N/R

Incluye sudadera para fácil impresión o bordado.



## GM 003

JUEGO BOUNCING BALL

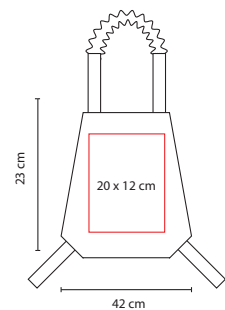

**Material:** Poliéster  
**Medida:** 42 x 23 cm  
**Área de Impresión:** 20 x 12 cm  
**Técnica de Impresión:** Serigrafía /  
 Tampografía en Pelota  
**Colores:** A/B/R

Incluye 2 piezas en bolsa individual con jareta y dos pelotas de hule natural.



GM 030

PIZARRÓN MÁGICO

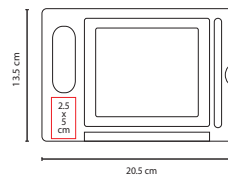

**Material:** Plástico  
**Medida:** 20.5 x 13.5 cm  
**Área de Impresión:** 2.5 x 5 cm  
**Técnica de Impresión:** Serigrafía  
**Colores:** Blanco con Plata

GM 050

AVIÓN ARMABLE

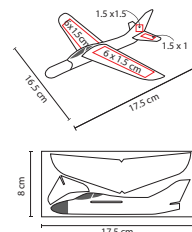

**Material:** Poliestireno  
**Medida:** 17.5 x 16.5 cm Armado  
**Área de Impresión:** 17.5 x 8 cm  
**Técnica de Impresión:** Serigrafía  
**Colores:** Blanco

Avión armable blanco con ventanas grises y punta de plástico.

INF 060

YOYO CLÁSICO



R



A



B



Y



V

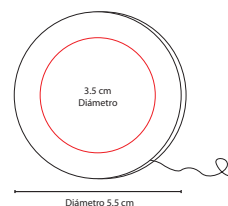

**Material:** Plástico  
**Medida:** 5.5 cm Diámetro  
**Área de Impresión:** 3.5 cm Diámetro  
**Técnica de Impresión:** Serigrafía  
**Colores:** Blanco Sólido / A/R/V/Y Translúcidos

Yoyo tradicional de plástico.

INF 010

YOYO LIGHT



A



R



B

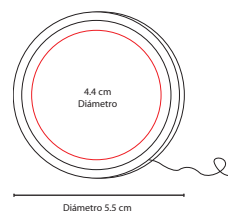
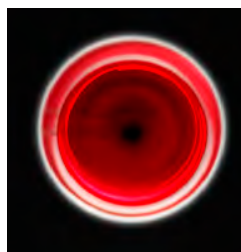

**Material:** Plástico  
**Medida:** 5.5 cm Diámetro  
**Área de Impresión:** 4.4 cm Diámetro  
**Técnica de Impresión:** Serigrafía  
**Colores:** A/B/R

Yoyo con luz. Incluye baterías.



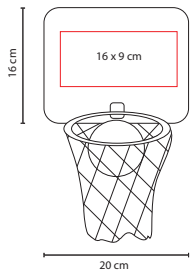

### GM 001

MINI CANASTA DE BASKET



**Material:** Plástico  
**Medida:** 20 x 16 cm  
**Área de Impresión:** 16 x 9 cm  
**Técnica de Impresión:** Serigrafía  
**Colores:** Blanco

Incluye pelota de basquetbol y red. Adhesivos fijadores en la parte posterior.



### INF 550

ESTUCHE COLOR SHOES

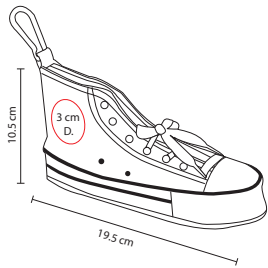

**Material:** Poliéster  
**Medida:** 19.5 x 10.5 cm  
**Área de Impresión:** 3 cm Diámetro  
**Técnica de Impresión:** Serigrafía  
**Colores:** A/P/R/Y

Incluye carabina.



R



Y



A



P



### GM 005

PAPALOTE DIAMOND

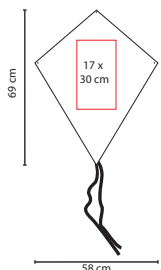

**Material:** Nylon  
**Medida:** 58 x 69 cm  
**Área de Impresión:** 17 x 30 cm  
**Técnica de Impresión:** Serigrafía  
**Colores:** A/R/V/Y

Incluye hilaza de 30 metros.

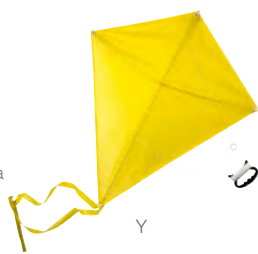

Y

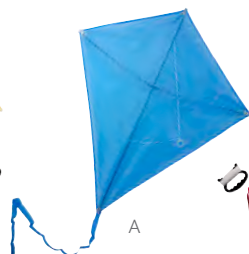

A

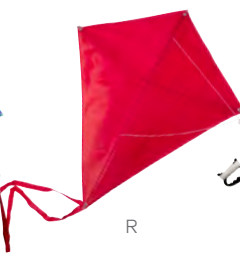

R



V



R

INF 300

CILINDRO CRAYÓN



A



V



Y

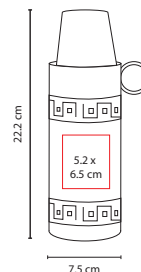

**Material:** Plástico  
**Medida:** 7.5 x 22.2 cm  
**Área de Impresión:** 5.2 x 6.5 cm  
**Técnica de Impresión:** Serigrafía /  
 Tampografía  
**Colores:** A/R/V/Y

500 ml. Incluye taza en la tapa.



V

KTC 010

LUNCH-MIX



R



O



A

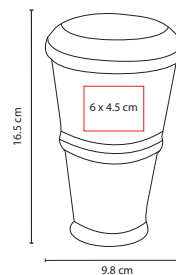

**Material:** Plástico  
**Medida:** 9.8 x 16.5 cm  
**Área de Impresión:** 6 x 4.5 cm  
**Técnica de Impresión:** Serigrafía /  
 Tampografía  
**Colores:** A/O/R/V

Compartimiento superior para alimentos sólidos. Compartimiento inferior para líquidos. Incluye cuchara.



INF 030

ALCANCIÓN CASITA

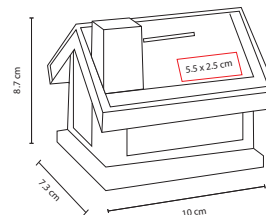

**Material:** Plástico  
**Medida:** 10 x 8.7 cm  
**Área de Impresión:** 5.5 x 2.5  
**Técnica de Impresión:** Serigrafía  
**Colores:** Blanco Frosty

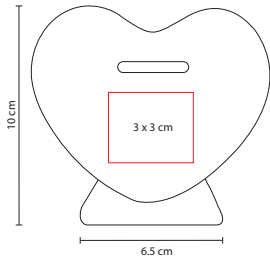

**Material:** Plástico  
**Medida:** 6.5 x 10 cm  
**Área de Impresión:** 3 x 3 cm  
**Técnica de Impresión:** Serigrafía /  
 Tampografía  
**Colores:** Rojo Translúcido



### INF 035

ALCANCÍA DE  
 CORAZÓN

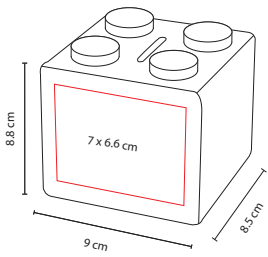

**Material:** Plástico  
**Medida:** 9 x 8.8 cm  
**Área de Impresión:** 7 x 6.6 cm  
**Técnica de Impresión:** Serigrafía  
**Colores:** A/B/R

### INF 100

ALCANCÍA CUBOS



R



B



A

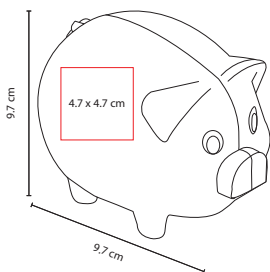

**Material:** Plástico  
**Medida:** 9.7 x 9.7 cm  
**Área de Impresión:** 4.7 x 4.7 cm  
**Técnica de Impresión:** Serigrafía /  
 Tampografía  
**Colores:** A/R/V/Y

### INF 040

ALCANCÍA PUERQUITO



A



R



Y



V

**INF 210**

BOLSA PORTA  
LÁPICES SARGAS

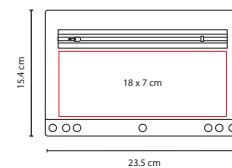

**Materia:** Vinil  
**Medida:** 23.5 x 15.4 cm  
**Área de Impresión:** 18 x 7 cm  
**Técnica de Impresión:** Serigrafía  
**Colores:** Blanco Frosty

No incluye colores.

**INF 012**

ESTUCHE DE  
GEOMETRÍA

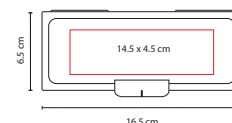
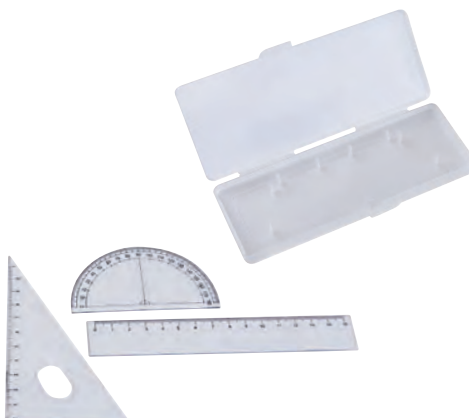
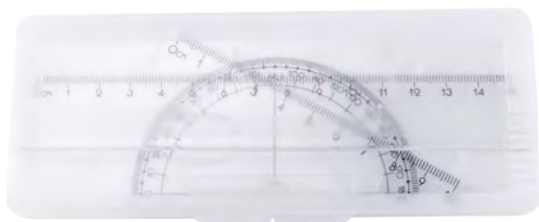

**Materia:** Plástico  
**Medida:** 16.5 x 6.5 cm  
**Área de Impresión:** 14.5 x 4.5 cm  
**Técnica de Impresión:** Serigrafía  
**Colores:** Blanco Frosty

Incluye regla, transportador y escuadra.

**KIT INF 100**

KIT ESCOLAR  
DRAWING

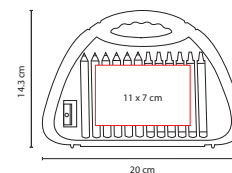

**Materia:** Plástico  
**Medida:** 20 x 14.3 cm  
**Área de Impresión:** 11 x 7 cm  
**Técnica de Impresión:** Serigrafía  
**Colores:** Translúcido

Incluye sacapuntas, 6 crayolas y 6 colores.

**INF 600**

ESTUCHE ESCOLAR  
MÁSTER



AC



AR



O



T



H



P



V



M



R



Y

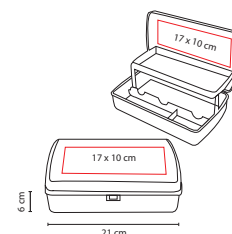

**Materia:** Plástico  
**Medida:** 21 x 6 cm  
**Área de Impresión:** 17 x 10 cm  
**Técnica de Impresión:** Serigrafía  
**Colores:** AC/AR/H/M/O/P/R/T/V/Y

Estuche con 4 divisiones. No incluye accesorios.

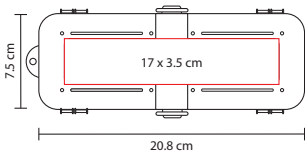

**Material:** Plástico  
**Medida:** 20.8 x 7.5 cm  
**Área de Impresión:** 17 x 3.5 cm  
**Técnica de Impresión:** Serigrafía  
**Colores:** A/O/R/V

Estuche porta lápices doble. Compartimentos de 4 y 2 separaciones. No incluye accesorios.

## INF 120

ESTUCHE NAPOLI

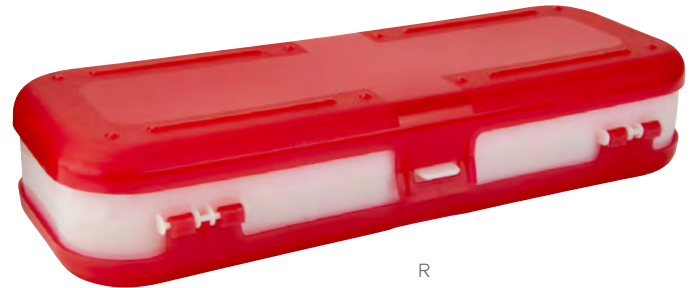

R



V

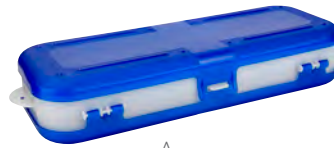

A



O

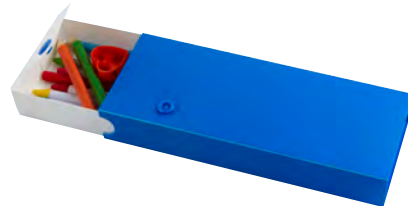

## INF 610

ESTUCHE MADY

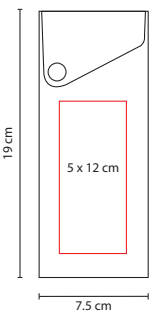

**Material:** Plástico  
**Medida:** 7.5 x 19 cm  
**Área de Impresión:** 5 x 12 cm  
**Técnica de Impresión:** Serigrafía  
**Colores:** A/O/R/V

Portalápices deslizable con botón. No incluye accesorios.



O



A



R



V



**PRE 003**

SET DE REGLA CON ACCESORIOS

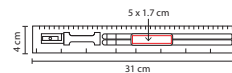

**Material:** Plástico  
**Medida:** 31 x 4 cm  
**Área de Impresión:** 5 x 1.7 cm  
**Técnica de Impresión:** Serigrafía  
**Colores:** Blanco

Incluye 2 lápices, 1 borrador, 1 sacapuntas y regla de 30 cm.



**DPO 007**

REGLA TRASLÚCIDA

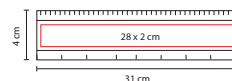

**Material:** Plástico  
**Medida:** 31 x 4 cm  
**Área de Impresión:** 28 x 2 cm  
**Técnica de Impresión:** Serigrafía  
**Colores:** A/B/R/V/Y

Regla de 30 cm.



**DPO 010-1**

BORRADOR

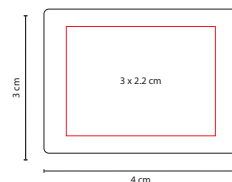

**Material:** Goma  
**Medida:** 4 x 3 cm  
**Área de Impresión:** 3 x 2.2 cm  
**Técnica de Impresión:** Serigrafía  
**Colores:** Blanco

Borrador tradicional.



**DPO 008**

LÁPIZ DE MADERA

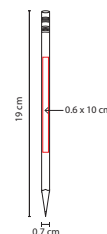

**Material:** Madera  
**Medida:** 0.7 x 19 cm  
**Área de Impresión:** 0.6 x 10 cm  
**Técnica de Impresión:** Serigrafía  
**Colores:** A/B/N/R/V/Y

Lápiz punta 2B, No. 2.

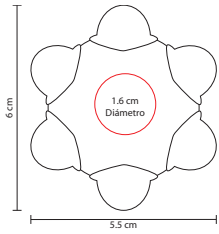

**Material:** Plástico  
**Medida:** 5.5 x 6 cm  
**Área de Impresión:** 1.6 cm Diámetro  
**Técnica de Impresión:** Goteado en Resina  
**Colores:** Blanco



Incluye crayolas en 6 colores: Azul, verde, rojo, rosa, amarillo y naranja.

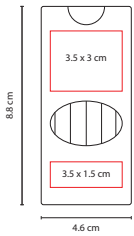

**Material:** Caja de Cartón  
**Medida:** 4.6 x 8.8 cm  
**Área de Impresión:** 3.5 x 3 cm  
**Técnica de Impresión:** Serigrafía  
**Colores:** Blanco



Caja de cartón con 6 colores cortos.

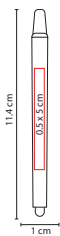

**Material:** Plástico  
**Medida:** 1 x 11.4 cm  
**Área de Impresión:** 0.5 x 5 cm  
**Técnica de Impresión:** Serigrafía  
**Colores:** A/N/O/R/V/Y



Mecanismo twist.

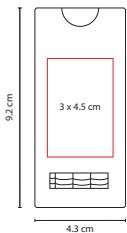

**Material:** Caja de Cartón  
**Medida:** 4.3 x 9.2 cm  
**Área de Impresión:** 3 x 4.5 cm  
**Técnica de Impresión:** Serigrafía  
**Colores:** Blanco



Caja de cartón con 5 crayolas de varios colores.

## DPO 025

CRAYOLA KANDI



## DPO 011-1

COLORES CORTOS



## SH 3000

CRAYOLA ARCOÍRIS



## DPO 014

CAJA DE CRAYOLAS



PRT 040

PORTARRETRATO  
RUBIC

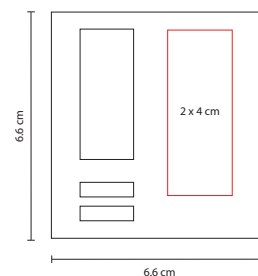
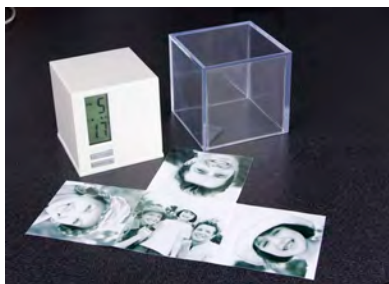

**Material:** Plástico  
**Medida:** 6.6 x 6.6 cm  
**Área de Impresión:** 2 x 4 cm  
**Técnica de Impresión:** Serigrafía  
**Colores:** Translúcido

Portarretrato con reloj, calendario y alarma. Tamaño de la foto 5.5 x 6 cm. Incluye baterías.

PRT 500

PORTARRETRATO  
HOPE

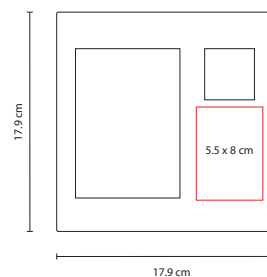

**Material:** Plástico  
**Medida:** 17.9 x 17.9 cm  
**Área de Impresión:** 5.5 x 8 cm  
**Técnica de Impresión:** Serigrafía  
**Colores:** Plata

Portarretrato con calendario y reloj. Tamaño de la foto 9 x 13 cm en 2 posiciones: horizontal y vertical. No incluye baterías.

PRT 400

PORTARRETRATO  
RELOJ MEDIA LUNA

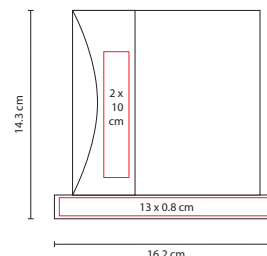

**Material:** Plástico  
**Medida:** 16.2 x 14.3 cm  
**Área de Impresión:** 2 x 10 cm  
**Técnica de Impresión:** Serigrafía  
**Colores:** Plata

Tamaño de la foto 9 x 13 cm. Incluye baterías.





**PRT 090**

PORTARRETRATO  
SAHURA

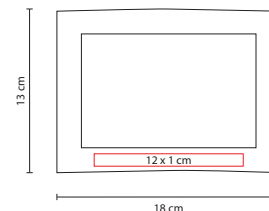

**Material:** Aluminio no Galvanizado  
**Medida:** 18 x 13 cm  
**Área de Impresión:** 12 x 1 cm  
**Técnica de Impresión:** Pantógrafo / Serigrafía  
**Colores:** Plata

2 Posiciones: horizontal y vertical. Tamaño de la foto 10 x 15 cm.

**PRT 080**

PORTARRETRATO MINI  
CAPRI

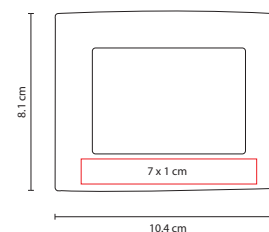

**Material:** Aluminio no Galvanizado  
**Medida:** 10.4 x 8.1 cm  
**Área de Impresión:** 7 x 1 cm  
**Técnica de Impresión:** Pantógrafo / Serigrafía  
**Colores:** Plata

2 Posiciones: horizontal y vertical. Tamaño de la foto 6 x 8 cm.

**PRT 001**

PORTARRETRATO  
LIVING

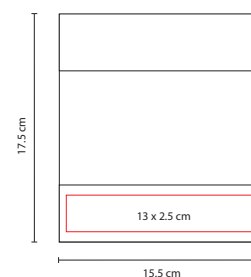

**Material:** Aluminio no Galvanizado  
**Medida:** 15.5 x 17.5 cm  
**Área de Impresión:** 13 x 2.5 cm  
**Técnica de Impresión:** Pantógrafo / Serigrafía  
**Colores:** Plata

2 Posiciones: horizontal y vertical. Tamaño de la foto 10 x 15 cm.

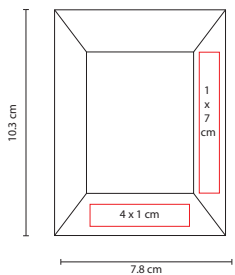

**Material:** Madera  
**Medida:** 7.8 x 10.3 cm  
**Área de Impresión:** 4 x 1 cm  
**Técnica de Impresión:** Láser / Serigrafía  
**Colores:** Madera

2 Posiciones: horizontal y vertical. Tamaño de la foto 5 x 5 cm.



## PRT 600

MINI PORTARRETRATO  
 FEEL WOOD

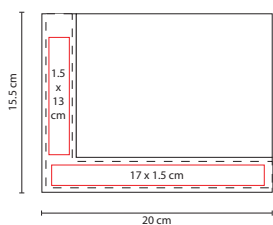

**Material:** Curpiel  
**Medida:** 20 x 15.5 cm  
**Área de Impresión:** 17 x 1.5 cm  
**Técnica de Impresión:** Láser / Serigrafía  
**Colores:** Café

2 Posiciones: horizontal y vertical. Tamaño de la foto 13 x 18 cm.



## PRT 200

PORTARRETRATO  
 FEELINGS

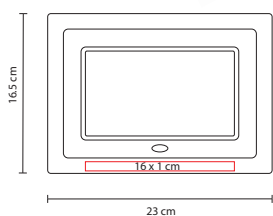

**Material:** Acrílico / Plástico  
**Medida:** 23 x 16.5 cm  
**Área de Impresión:** 16 x 1 cm  
**Técnica de Impresión:** Serigrafía  
**Colores:** Plata

Conexión USB, reloj, calendario, alarma, películas, música MP3 y MP4, control remoto. No incluye USB.



## PRT 100

PORTARRETRATO  
 DIGITAL 7"



**PRT 060**

PORTARRETRATO  
SUITE 1

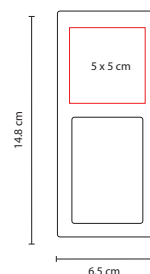

**Material:** Aluminio no Galvanizado  
**Medida:** 6,5 x 14,8 cm  
**Área de Impresión:** 5 x 5 cm  
**Técnica de Impresión:** Pantógrafo / Serigrafía  
**Colores:** Plata

2 Posiciones: horizontal y vertical. Tamaño de la foto 5 x 7.5 cm.

**PRT 105**

PORTARRETRATO  
CURVO SLIDE



VT



AT



RT

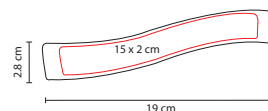

**Material:** Plástico  
**Medida:** 19 x 2,8 cm  
**Área de Impresión:** 15 x 2 cm  
**Técnica de Impresión:** Tampografía  
**Colores:** AT/RT/VT

Tamaño de la foto 10 x 15 cm.

**PRT 350**

PORTARRETRATO  
EMOTION

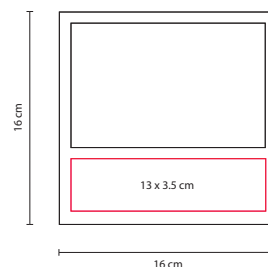

**Material:** Aluminio no Galvanizado  
**Medida:** 16 x 16 cm  
**Área de Impresión:** 13 x 3,5 cm  
**Técnica de Impresión:** Láser / Serigrafía  
**Colores:** Plata

2 Posiciones: horizontal y vertical. Tamaño de la foto 6 x 4 cm.



KTC 006

SET BILBAO

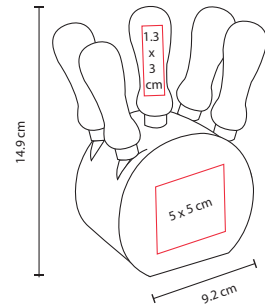

**Material:** Madera  
**Medida:** 9.2 x 14.9 cm  
**Área de Impresión:** 5 x 5 cm Base /  
1.3 x 3 cm Mango  
**Técnica de Impresión:** Láser / Serigrafía  
**Colores:** Madera

Incluye 5 accesorios de cocina.

PWT 050

SET VALENCIA

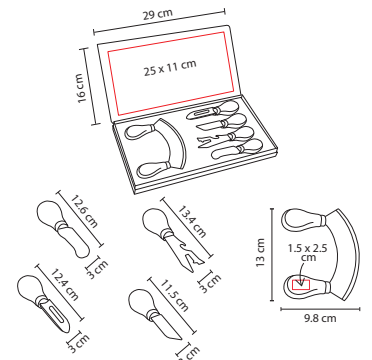

**Material:** Madera / Metal  
**Medida:** 29 x 16 cm  
**Área de Impresión:** 25 x 11 cm Estuche /  
1.5 x 2.5 cm Mango  
**Técnica de Impresión:** Láser / Serigrafía  
**Colores:** Madera

Incluye 5 accesorios de cocina y estuche.

## PWT 030

### SET ASTURIAS

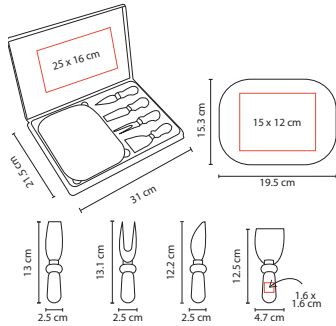

**Material:** Madera / Metal  
**Medida:** 31 x 21.5 cm  
**Área de Impresión:** 25 x 16 cm Estuche /  
15 x 12 cm Tabla  
**Técnica de Impresión:** Láser / Serigrafía  
**Colores:** Madera

Incluye 4 accesorios de cocina, tabla de madera y estuche.

## PW 0025

### TABLA ANDALUCÍA

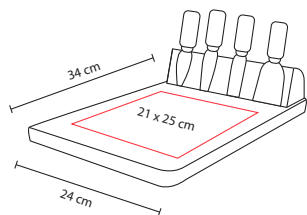

**Material:** Madera / Metal  
**Medida:** 24 x 34 cm  
**Área de Impresión:** 21 x 25 cm  
**Técnica de Impresión:** Láser / Serigrafía  
**Colores:** Madera

Incluye 4 cuchillos para cortar quesos. Tabla con imán.

PWT 060

JUEGO DE CUCHILLOS LONDON

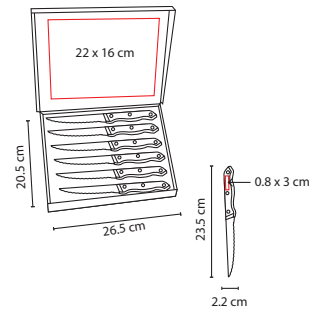

**Material:** Metal / Plástico  
**Medida:** 26.5 x 20.5 cm Estuche / 2.2 x 23.5 cm Cuchillo  
**Área de Impresión:** 22 x 16 cm Estuche / 0.8 x 3 cm Mango  
**Técnica de Impresión:** Serigrafía  
**Colores:** Negro

Incluye 6 cuchillos y estuche.

PWT 080

JUEGO DE CUBIERTOS TURNER

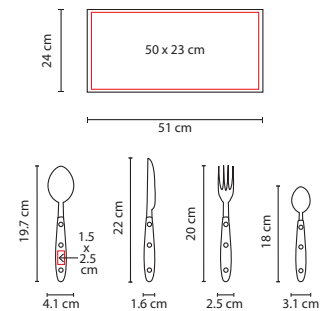

**Material:** Metal / Plástico  
**Medida:** 51 x 24 cm Estuche  
**Área de Impresión:** 50 x 23 cm  
**Técnica de Impresión:** Láser / Serigrafía  
**Colores:** Negro

Incluye 24 piezas para seis personas y estuche de madera.





## KTC 100

SET DE CUCHILLOS  
CORVI

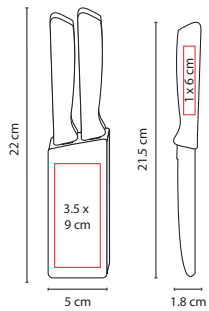

**Material:** Acero / Madera / Plástico  
**Medida:** 5 x 22 cm  
**Área de Impresión:** 3.5 x 9 cm Base /  
 1 x 6 cm Mango  
**Técnica de Impresión:** Láser / Serigrafía  
**Colores:** Base Color Madera / Cuchillos  
 Color Negro.

Incluye 6 cuchillos y base de madera.



## KTC 014

BOTANERO ALHENA

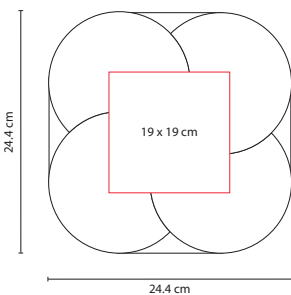

**Material:** Plástico  
**Medida:** 24.4 x 24.4 cm  
**Área de Impresión:** 19 x 19 cm  
**Técnica de Impresión:** Serigrafía  
**Colores:** Blanco

Charola con 4 botaneros y tapa.



**KTC 004**  
GUANTE PARA COCINA

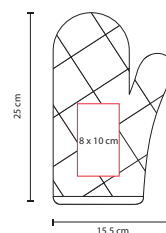

**Material:** Algodón  
**Medida:** 15.5 x 25 cm  
**Área de Impresión:** 8 x 10 cm  
**Técnica de Impresión:** Bordado / Serigrafía  
**Colores:** Blanco



**KTC 005**  
AGARRADERA CHOP

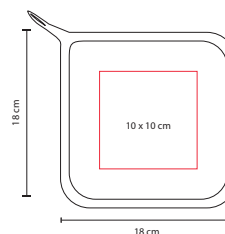

**Material:** Algodón  
**Medida:** 18 x 18 cm  
**Área de Impresión:** 10 x 10 cm  
**Técnica de Impresión:** Bordado / Serigrafía  
**Colores:** Blanco

Sujetador de utensilios calientes.



**KTC 003**  
MANDIL PARA COCINA

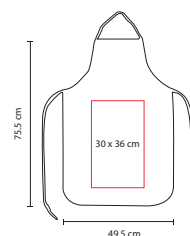

**Material:** Algodón  
**Medida:** 49.5 x 75.5 cm  
**Área de Impresión:** 30 x 36 cm  
**Técnica de Impresión:** Bordado / Serigrafía  
**Colores:** Blanco



**KTC 009**  
CUBIERTOS PICNIC

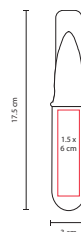
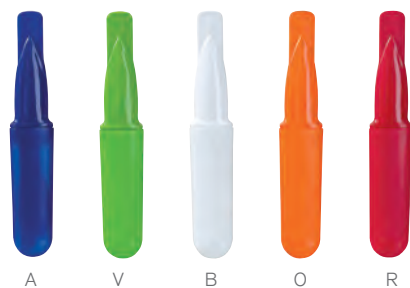

**Material:** Plástico  
**Medida:** 3 x 17.5 cm  
**Área de Impresión:** 1.5 x 6 cm  
**Técnica de Impresión:** Serigrafía  
**Colores:** A/B/O/R/V

Incluye tenedor, cuchara y cuchillo.

KTC 008

LONCHERA BENTO



**Material:** Plástico  
**Medida:** 22 x 5,5 cm  
**Área de Impresión:** 5 x 2 cm  
**Técnica de Impresión:** Serigrafía  
**Colores:** A/B/O/R/V

Incluye cuchara, tenedor y cuchillo. 3 Compartimentos.

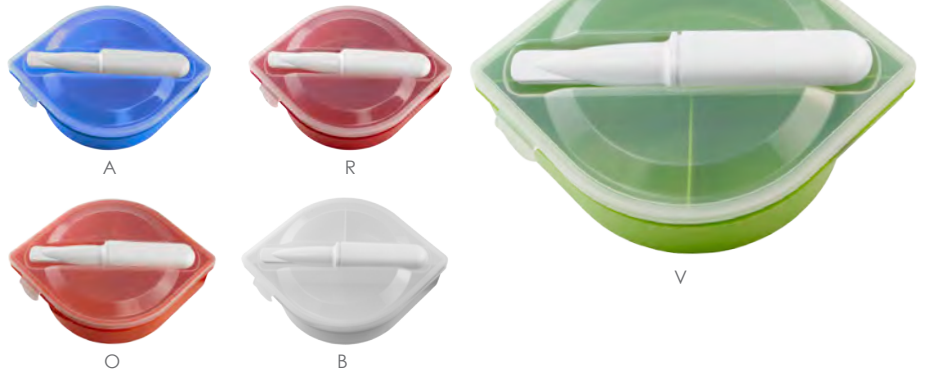

KTC 007

PORTAVIANDAS BEYLA



**Material:** Plástico  
**Medida:** 20 x 16 cm  
**Área de Impresión:** 12 x 3 cm  
**Técnica de Impresión:** Serigrafía  
**Colores:** A/R

Incluye tenedor, cuchara y cuatro recipientes.



KTC 015

PORTAVIANDAS SENYA



**Material:** Plástico / Acero Inoxidable  
**Medida:** 17 x 13,5 cm  
**Área de Impresión:** 6 x 3 cm  
**Técnica de Impresión:** Serigrafía / Tampografía  
**Colores:** Blanco

Incluye dos recipientes para alimentos. Compartimento superior para líquidos e inferior para sólidos. Con agarradera doble, válvula de silicón y broches sujetadores.



BBQ 003

SET BBQ SNAZZY

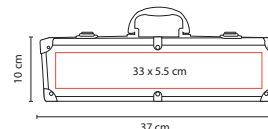

**Material:** Acero Inoxidable / Aluminio  
**Medida:** 37 x 10 cm  
**Área de Impresión:** 33 x 5,5 cm  
**Técnica de Impresión:** Láser / Serigrafía  
**Colores:** Plata

Incluye pinzas, espátula, tenedor para BBQ y estuche metálico.

BBQ 006

SET BBQ GRILL

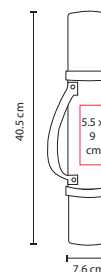

**Material:** Acero Inoxidable / Metal / Plástico  
**Medida:** 7,6 x 40,5 cm  
**Área de Impresión:** 5,5 x 9 cm  
**Técnica de Impresión:** Láser / Serigrafía / Tampografía  
**Colores:** Plata con Negro

Incluye una pinza, un tenedor y una espátula.

BBQ 001

HIELERA BBQ

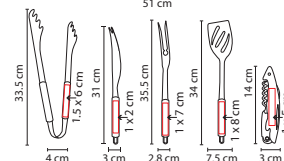
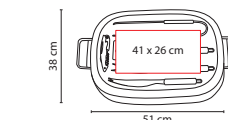

**Material:** Acero Inoxidable / Plástico  
**Medida:** 51 x 38 cm  
**Área de Impresión:** 41 x 26 cm  
**Técnica de Impresión:** Láser en Accesorios / Serigrafía en Tapa  
**Colores:** Negro

Incluye sacacorchos con destapador, tenedor, espátula, cuchillo y tenazas en acero inoxidable. Hielera plegable con tapadera.

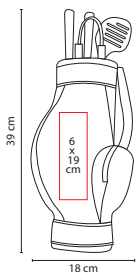

**Material:** Acero Inoxidable / Curpiel  
**Medida:** 18 x 39 cm  
**Área de Impresión:** 6 x 19 cm  
**Técnica de Impresión:** Serigrafía / Termograbado  
**Colores:** Blanco con Negro

Incluye dos compartimentos, espátula, tenedor para BBQ, pinzas y cuchillo.



## BBQ 004

SET BBQ GOLF

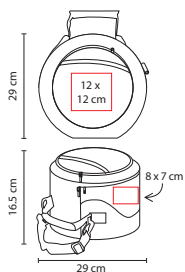

**Material:** Metal / Poliéster  
**Medida:** 29 x 16.5 cm  
**Área de Impresión:** 12 x 12 cm  
**Técnica de Impresión:** Bordado / Serigrafía  
**Colores:** Negro con Gris

Incluye parrillas. Hielera solo en la parte superior.



## BBQ 002

ASADOR CON  
HIELERA CAMPING

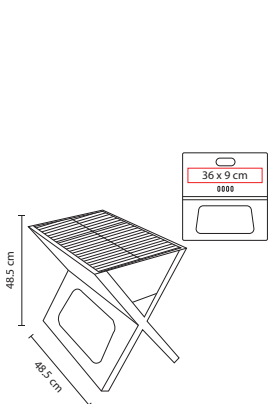

**Material:** Metal  
**Medida:** 48.5 x 48.5 cm  
**Área de Impresión:** 36 x 9 cm  
**Técnica de Impresión:** Láser / Pantógrafo / Serigrafía  
**Colores:** Negro

Incluye base para carbón y parrilla plegable.

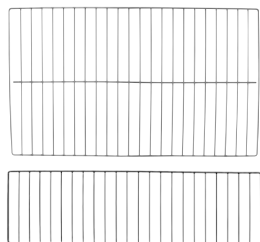

## BBQ 005

ASADOR PLEGABLE  
MALAWI

## COB 001

FRAZADA MINYA

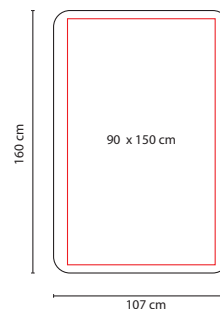

**Material:** Poliéster  
**Medida:** 107 x 160 cm  
**Área de Impresión:** 90 x 150 cm  
**Técnica de Impresión:** Bordado  
**Colores:** A/BE/H

## COB 002

FRAZADA ROLLY HUG



A



N



R

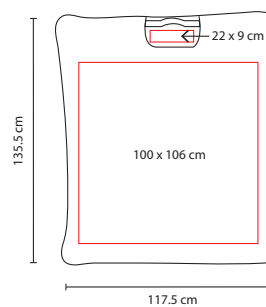

**Material:** Poliéster  
**Medida:** 117.5 x 135.5 cm  
**Área de Impresión:** 100 x 106 cm  
**Técnica de Impresión:** Bordado  
**Colores:** A/N/R



**ABA 001**

ABANICO SEAT

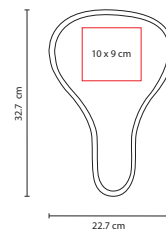
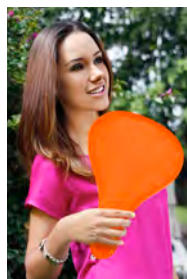
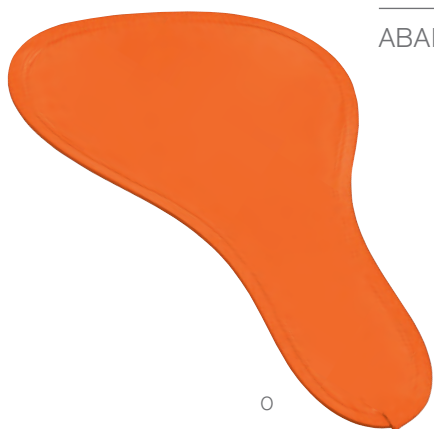

**Material:** Nylon  
**Medida:** 22.7 x 32.7 cm  
**Área de Impresión:** 10 x 9 cm  
**Técnica de Impresión:** Serigrafía  
**Colores:** A/O/R/V

Abanico doblable con elástico.

**PRO 111**

IDENTIFICADOR DE MALETAS HARBEL

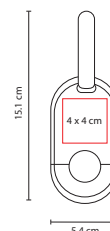

**Material:** Plástico  
**Medida:** 5.4 x 15.1 cm  
**Área de Impresión:** 4 x 4 cm  
**Técnica de Impresión:** Serigrafía  
**Colores:** A/B/R

**PRO 115**

IDENTIFICADOR DE MALETAS ARMSTRONG

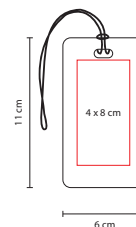

**Material:** Plástico  
**Medida:** 6 x 11 cm  
**Área de Impresión:** 4 x 8 cm  
**Técnica de Impresión:** Serigrafía  
**Colores:** A/B/N/R

Incluye papel para datos y correa de plástico.

**SIN 900**

ZAPATERA QUEST CLUB

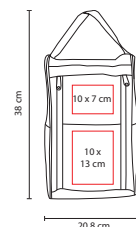

**Material:** Poliéster  
**Medida:** 20.8 x 38 cm  
**Área de Impresión:** 10 x 7 cm  
**Técnica de Impresión:** Bordado / Serigrafía  
**Colores:** Negro con Gris



## SIN 420

PORTA DOCUMENTOS  
DE VIAJE SIERO

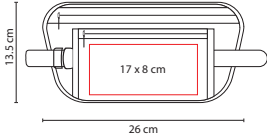

**Material:** Poliéster  
**Medida:** 26 x 13.5 cm  
**Área de Impresión:** 17 x 8 cm  
**Técnica de Impresión:** Bordado / Serigrafía  
**Colores:** Negro

Compartimento principal y bolsa frontal. Incluye elástico para sujetar a la cintura.

## M 80780

PORTA PASAPORTE

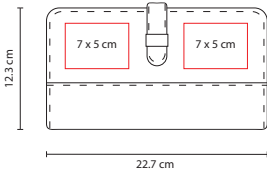

**Material:** Curpiel  
**Medida:** 22.7 x 12.3 cm  
**Área de Impresión:** 7 x 5 cm  
**Técnica de Impresión:** Láser / Serigrafía /  
Termograbado  
**Colores:** Negro

Compartimento para visa, pasaporte, boleto de avión y tarjeta de crédito.

## SIN 721

ORGANIZADOR DE  
VIAJE BAGEM

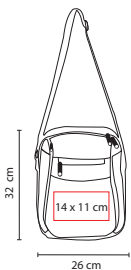

**Material:** Poliéster  
**Medida:** 26 x 32 cm  
**Área de Impresión:** 14 x 11 cm  
**Técnica de Impresión:** Bordado  
**Colores:** Negro con Plata

Bolsa frontal con mini bolsa. Bolsa intermedia con un compartimento.

**BAS 001**

BÁSCULA PARA MALETAS

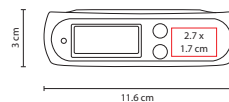

**Material:** Plástico  
**Medida:** 11.6 x 3 cm  
**Área de Impresión:** 2.7 x 1.7 cm  
**Técnica de Impresión:** Serigrafía  
**Colores:** Negro con Plata

Con display digital. Incluye correa y baterías.  
 Capacidad máxima 45 kg.

**ADC 008**

ADAPTADOR TRAVELER

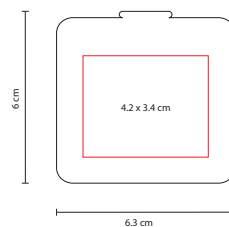

**Material:** Plástico  
**Medida:** 6.3 x 6 cm  
**Área de Impresión:** 4.2 x 3.4 cm  
**Técnica de Impresión:** Serigrafía  
**Colores:** Blanco

Adaptador universal con protector de seguridad para niños, indicadores de voltaje y con 4 diferentes tipos de clavijas. Incluye funda y estuche.

**SIN 012**

TRAVEL KIT

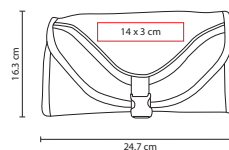

**Material:** Poliéster / Nylon  
**Medida:** 24.7 x 16.3 cm  
**Área de Impresión:** 14 x 3 cm  
**Técnica de Impresión:** Bordado / Serigrafía  
**Colores:** Negro

Incluye espejo. Accesorios no incluidos.

**SIN 011**

PORTATRAJES PORTAFOLIO

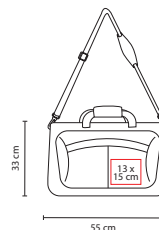

**Material:** Poliéster / Nylon  
**Medida:** 55 x 33 cm  
**Área de Impresión:** 13 x 15 cm  
**Técnica de Impresión:** Bordado / Serigrafía  
**Colores:** N/S

Bolsa frontal y posterior. Incluye espacio para trajes.

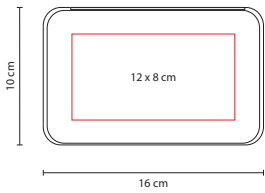

**Material:** Poliéster / Gamuza / Plástico  
**Medida:** 16 x 10 cm Estuche  
**Área de Impresión:** 12 x 8 cm  
**Técnica de Impresión:** Serigrafía  
**Colores:** Negro

Contiene antifaz para dormir, almohada inflable de viaje, cepillo portátil y estuche.

## PRO 540

KIT REST

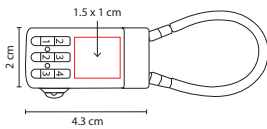
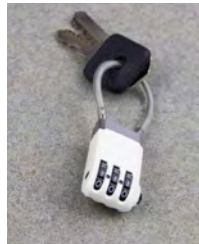
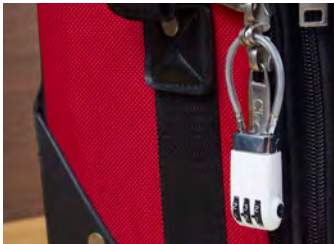

**Material:** Plástico  
**Medida:** 2 x 4.3 cm  
**Área de Impresión:** 1.5 x 1 cm  
**Técnica de Impresión:** Serigrafía  
**Colores:** Blanco

3 Funciones: Llavero, candado para USB para proteger información y candado para maleta. Combinación de 3 dígitos. No incluye USB.

## BLQ 001

CANDADO SARY



## DAM 020

NECESER EVAN

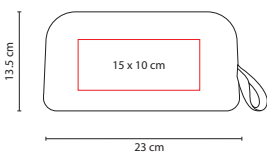

**Material:** Poliéster  
**Medida:** 23 x 13.5 cm  
**Área de Impresión:** 15 x 10 cm  
**Técnica de Impresión:** Bordado / Serigrafía  
**Colores:** Negro con Gris

Incluye correa en cierre.

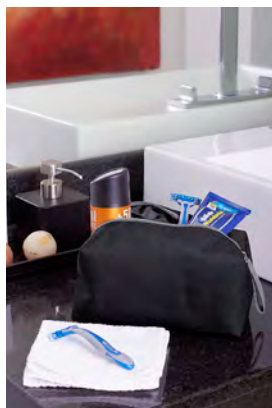

TOA 001

TOALLA ALBA



R



A



B

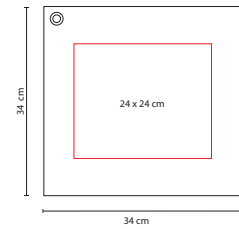

**Material:** Algodón  
**Medida:** 34 x 34 cm  
**Área de Impresión:** 24 x 24 cm  
**Técnica de Impresión:** Bordado  
**Colores:** A/B/R

Terminado rasurado al frente. Incluye ojillo metálico.

TOA 002

TOALLA IRIS

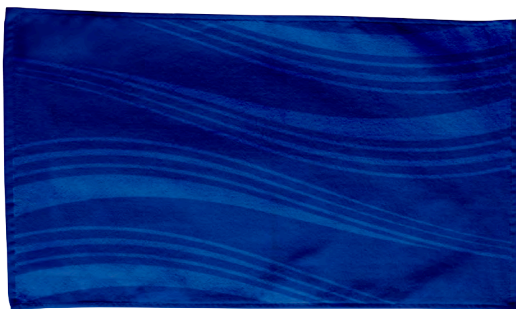

A

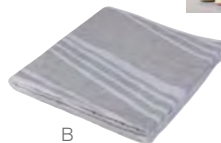

B



R

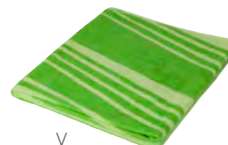

V

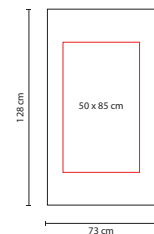

**Material:** Algodón  
**Medida:** 73 x 128 cm  
**Área de Impresión:** 50 x 85 cm  
**Técnica de Impresión:** Bordado  
**Colores:** A/B/R/V

Terminado rasurado al frente.

BCH 001

TAPETE DE PLAYA BAHAMAS



R



B

A

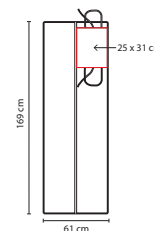

**Material:** Hoja de Arroz / Poliéster  
**Medida:** 61 x 169 cm  
**Área de Impresión:** 25 x 31 cm  
**Técnica de Impresión:** Serigrafía  
**Colores:** A/B/R

Cuenta con agarradera.

BCH 003

TAPETE DE PLAYA BARÚ



R

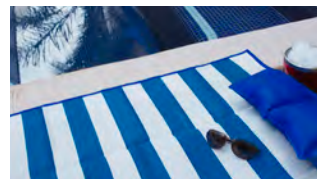

A

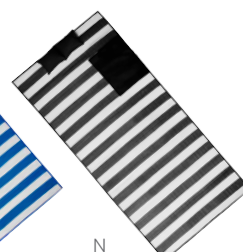

N

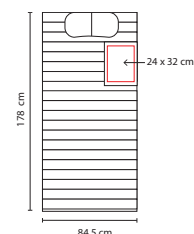

**Material:** Plástico / Non Woven  
**Medida:** 84.5 x 178 cm  
**Área de Impresión:** 24 x 32 cm  
**Técnica de Impresión:** Serigrafía  
**Colores:** A/N/R

Incluye almohadilla inflable. Cuenta con agarradera.

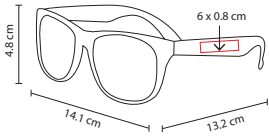

**Material:** Plástico  
**Medida:** 14.1 x 4.8 cm  
**Área de Impresión:** 6 x 0.8 cm  
**Técnica de Impresión:** Serigrafía  
**Colores:** A/N/R/V/Y

Protección UV 400.



Y



R



A



N

## LEN 001

LENTES SUNSET



V

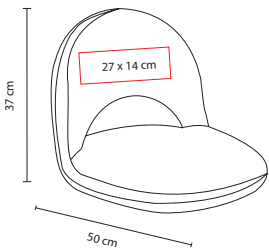

**Material:** Poliéster / Tubo de acero.  
**Medida:** 50 x 37 cm  
**Área de Impresión:** 27 x 14 cm  
**Técnica de Impresión:** Bordado / Serigrafía  
**Colores:** A/N/R

Silla reclinable para viaje con correa.



N

R

## KTC 012

SILLA FREEDOM



A

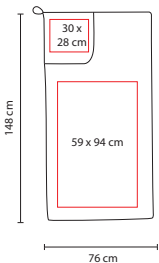

**Material:** Algodón  
**Medida:** 76 x 148 cm  
**Área de Impresión:** 59 x 94 cm  
**Técnica de Impresión:** Bordado  
**Colores:** A/B/R

Bolsa con toalla.

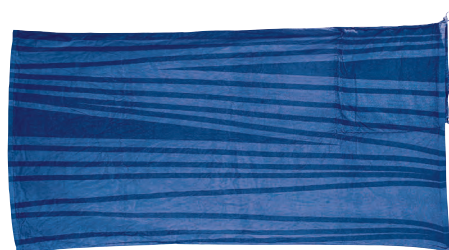

## SIN 800

BOLSA TOALLA SUNNY



A



R



B

PAR 06

PARAGUAS  
CHARLESTON

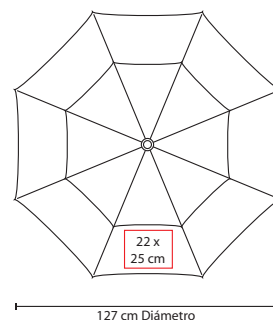

127 cm Diámetro

**Material:** Nylon  
**Medida:** 127 cm Diámetro  
**Área de Impresión:** 22 x 25 cm  
**Técnica de Impresión:** Serigrafía  
**Colores:** Blanco con Negro

8 Paneles dobles, mango de EVA, incluye funda con agarradera.

PAR 02

PARAGUAS GIGANTE

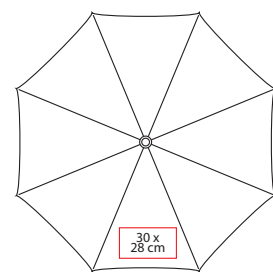
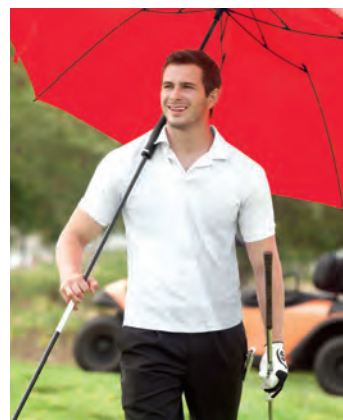

140 cm Diámetro

**Material:** Nylon  
**Medida:** 140 cm Diámetro  
**Área de Impresión:** 30 x 28 cm  
**Técnica de Impresión:** Serigrafía  
**Colores:** A/N/R

8 Paneles, incluye funda y extensor de 1.23 m.



PAR 04

PARAGUAS DE BOLSILLO

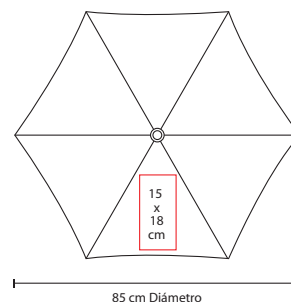

**Material:** Nylon  
**Medida:** 22.5 cm Cerrado / 85 cm Diámetro  
**Área de Impresión:** 15 x 18 cm  
**Técnica de Impresión:** Serigrafía  
**Colores:** Negro

6 Paneles, incluye funda.

PAR 01

PARAGUAS CON FUNDA

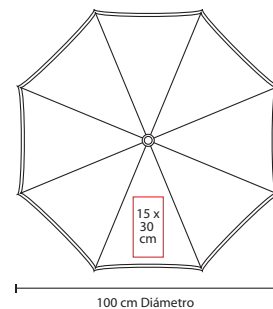

**Material:** Nylon  
**Medida:** 100 cm Diámetro  
**Área de Impresión:** 15 x 30 cm  
**Técnica de Impresión:** Serigrafía  
**Colores:** A/B/N/O/R/V/Y

8 Paneles, incluye funda.



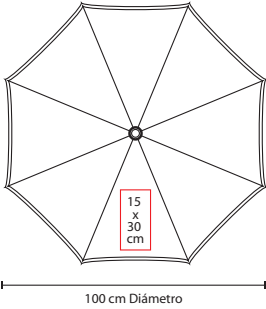

**Material:** Nylon  
**Medida:** 100 cm Diámetro  
**Área de Impresión:** 15 x 30 cm  
**Técnica de Impresión:** Serigrafía  
**Colores:** A/N/O/R/V

8 Paneles, mango de EVA, incluye funda.



## PAR 05

PARAGUAS SILVER  
TROPIC



## PAR 03

PARAGUAS  
CUADRADO

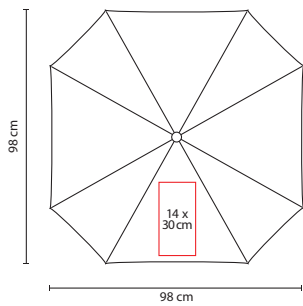

**Material:** Nylon  
**Medida:** 98 x 98 cm  
**Área de Impresión:** 14 x 30 cm  
**Técnica de Impresión:** Serigrafía  
**Colores:** A/N/O/R/V/Y

8 Paneles, incluye cordón.

### LAM 5557

LÁSER LÁMPARA  
PROFESSIONAL

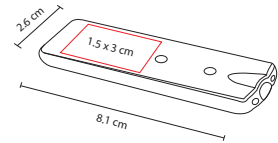
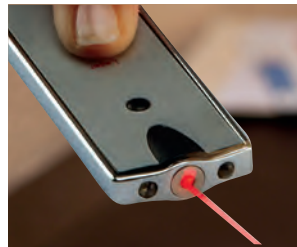

**Material:** Plástico  
**Medida:** 2.6 x 8.1 cm  
**Área de Impresión:** 1.5 x 3 cm  
**Técnica de Impresión:** Serigrafía  
**Colores:** Plata

2 LEDs. Funda curpiel, lámpara y láser. Incluye batería de botón.

### LAM 300

LÁMPARA RIDER

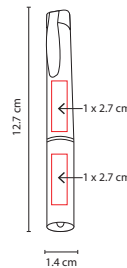

**Material:** Plástico  
**Medida:** 1.4 x 12.7 cm  
**Área de Impresión:** 1 x 2.7 cm  
**Técnica de Impresión:** Serigrafía  
**Colores:** B/P

1 LED, luz blanca. Incluye batería de botón.

### LAM 500

TARJETA  
MULTIFUNCIONES  
6 EN 1

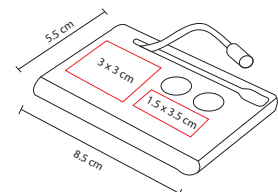
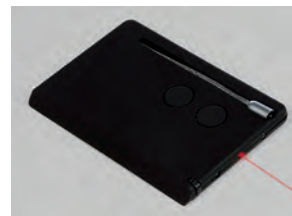
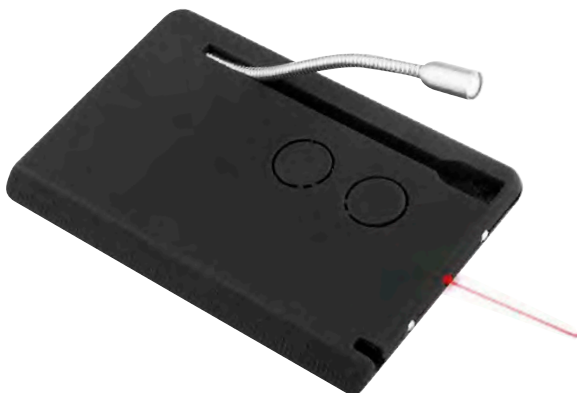

**Material:** Plástico  
**Medida:** 8.5 x 5.5 cm  
**Área de Impresión:** 3 x 3 cm  
**Técnica de Impresión:** Serigrafía  
**Colores:** Negro

Contiene láser, 2 lámparas, tijeras, regla y bolígrafo. Incluye batería de botón.



LAM 584

LÁMPARA LLAVERO  
FIVE LIGHT

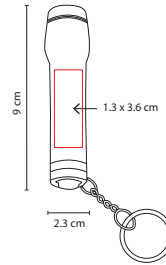

**Material:** Aluminio  
**Medida:** 2.3 x 9 cm  
**Área de Impresión:** 1.3 x 3.6 cm  
**Técnica de Impresión:** Pantógrafo / Serigrafía  
**Colores:** Plata

5 LEDS. Incluye estuche y batería (AA).

LAM 2365

LÁMPARA DE  
LECTURA CON CLIP



A



R



B

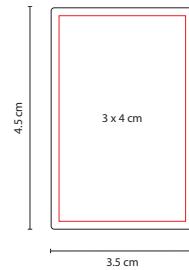

**Material:** Plástico  
**Medida:** 3.5 x 4.5 cm  
**Área de Impresión:** 3 x 4 cm Estuche.  
**Técnica de Impresión:** Serigrafía / Tampografía  
**Colores:** A/B/R

1 LED. Incluye estuche y batería de botón.

LAM 621

LÁMPARA BIG LIGHT

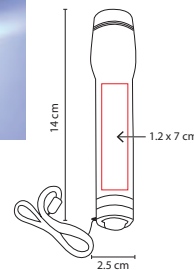

**Material:** Aluminio  
**Medida:** 2.5 x 14 cm  
**Área de Impresión:** 1.2 x 7 cm  
**Técnica de Impresión:** Pantógrafo / Serigrafía  
**Colores:** Plata



5 LEDS. Incluye estuche, cordón y baterías (AA).

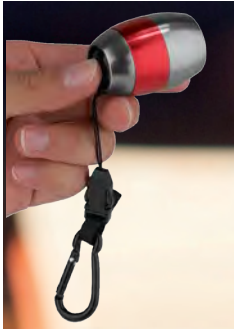

## LAM 700

LÁMPARA RUSH

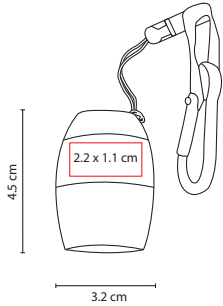

R



N



A

**Material:** Metal  
**Medida:** 3.2 x 4.5 cm  
**Área de Impresión:** 2.2 x 1.1 cm  
**Técnica de Impresión:** Pantógrafo / Serigrafía  
**Colores:** A/R/N

6 LEDS. Incluye correa con gancho y batería de botón.



## LAM 100

LÁMPARA KOBOK

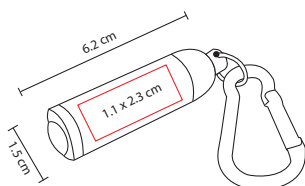

A



N



S



R

**Material:** Metal / Plástico  
**Medida:** 1.5 x 6.2 cm  
**Área de Impresión:** 1.1 x 2.3 cm  
**Técnica de Impresión:** Serigrafía  
**Colores:** A/N/R/S

1 LED. Incluye gancho y batería de botón.

LAM 550

LÁMPARA ANGUS



R



A



S

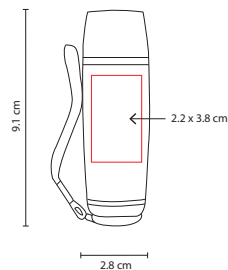

**Material:** Aluminio  
**Medida:** 2.8 x 9.1 cm  
**Área de Impresión:** 2.2 x 3.8 cm  
**Técnica de Impresión:** Pantógrafo / Serigrafía  
**Colores:** A/R/S Metalizados

9 LEDS. Incluye cordón y baterías (AAA).

LAM 1450

LÁMPARA FRICTION LIGHT

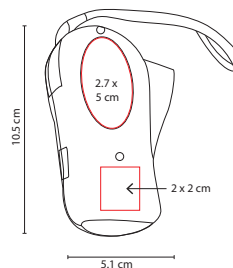

**Material:** Plástico  
**Medida:** 5.1 x 10.5 cm  
**Área de Impresión:** 2.7 x 5 cm  
**Técnica de Impresión:** Serigrafía / Goteado en Resina  
**Colores:** Humo

3 LEDS. No necesita baterías, se recarga por fricción. Incluye cordón.

LAM 800

LÁMPARA OBELIX

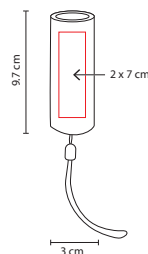

**Material:** Metal  
**Medida:** 3 x 9.7 cm  
**Área de Impresión:** 2 x 7 cm  
**Técnica de Impresión:** Pantógrafo / Serigrafía  
**Colores:** Plata Metalizado

9 LEDS. En forma triangular, incluye correa y baterías (AAA).

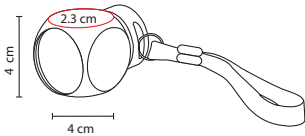

**Material:** Aluminio  
**Medida:** 4 x 4 cm  
**Área de Impresión:** 2.3 cm Diámetro  
**Técnica de Impresión:** Pantógrafo / Serigrafía  
**Colores:** Gris Oxford

6 LEDS. Incluye cordón y batería de botón.

## LAM 350

LÁMPARA ARVE

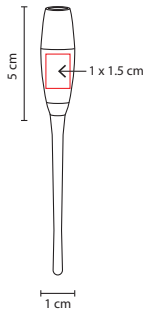

**Material:** Aluminio  
**Medida:** 1 x 5 cm  
**Área de Impresión:** 1 x 1.5 cm  
**Técnica de Impresión:** Pantógrafo / Serigrafía  
**Colores:** A/N/R

1 LED. Incluye sujetador de hule y batería de botón.

## LAM 450

LÁMPARA CIRY



LAM 600

LÁMPARA CON  
NAVAJA PATHFINDER

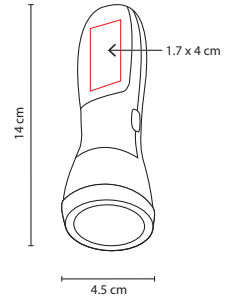

**Material:** Metal / Plástico  
**Medida:** 4.5 x 14 cm  
**Área de Impresión:** 1.7 x 4 cm  
**Técnica de Impresión:** Pantógrafo / Serigrafía  
**Colores:** Plata con Negro

4 LEDS con flash y navaja de 8 funciones. Incluye estuche y baterías (AAA).

LAM 200

LÁMPARA RAZOR



N

R

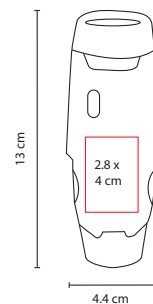

**Material:** Metal / Plástico  
**Medida:** 4.4 x 13 cm  
**Área de Impresión:** 2.8 x 4 cm  
**Técnica de Impresión:** Serigrafía  
**Colores:** A/N/R

5 LEDS. Foco rojo intermitente y navaja de 8 funciones. Incluye caja de regalo y baterías (AAA).



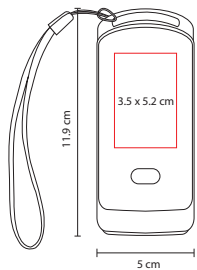

**Material:** Plástico  
**Medida:** 5 x 11.9 cm  
**Área de Impresión:** 3.5 x 5.2 cm  
**Técnica de Impresión:** Serigrafía  
**Colores:** Blanco con Plata



## LAM 950

LÁMPARA SOHO



5 LEDs. Lámpara solar con fotoceldas, luz intermitente y correa.

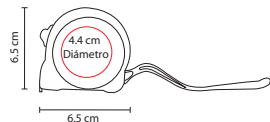

**Material:** Plástico / Metal  
**Medida:** 6.5 x 6.5 cm  
**Área de Impresión:** 4.4 cm Diámetro  
**Técnica de Impresión:** Goteado en Resina / Serigrafía  
**Colores:** Blanco



## HER 019

FLEXÓMETRO LUCCA

Flexómetro cinta metálica de 5 m. Incluye correa, clip y seguro.

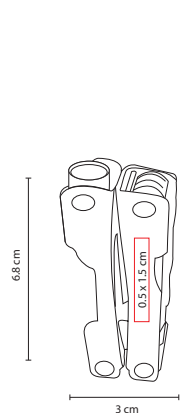

## HER 015

MINI PINZAS QUARK

**Material:** Metal  
**Medida:** 3 x 6.8 cm  
**Área de Impresión:** 0.5 x 1.5 cm  
**Técnica de Impresión:** Láser / Pantógrafo  
**Colores:** Plata

Mini pinzas de 7 funciones, cuenta con lámpara de 1 LED, navaja, desarmador de cruz, serrucho, destapador con punta de desarmador plano. Incluye funda y batería de botón.



ST 060

MINI NAVAJA DURANGO

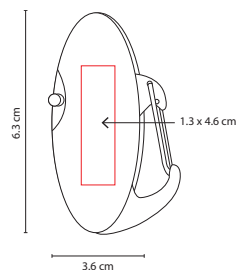

**Material:** Metal  
**Medida:** 3.6 x 6.3 cm  
**Área de Impresión:** 1.3 x 4.6 cm  
**Técnica de Impresión:** Láser / Pantógrafo / Serigrafía  
**Colores:** Gris Oxford Metalizado

Con gancho y seguro.

ST 040

NAVAJA AMERICAN EAGLE

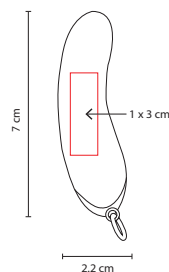

**Material:** Metal  
**Medida:** 2.2 x 7 cm  
**Área de Impresión:** 1 x 3 cm  
**Técnica de Impresión:** Pantógrafo / Serigrafía  
**Colores:** Plata

4 Funciones. Incluye estuche.

ST 070

NAVAJA CON HERRAMIENTAS PREMIER

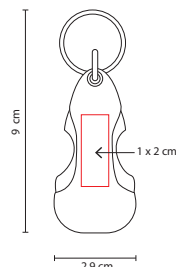

**Material:** Metal  
**Medida:** 2.9 x 9 cm  
**Área de Impresión:** 1 x 2 cm  
**Técnica de Impresión:** Pantógrafo / Serigrafía  
**Colores:** Gris Oxford Metalizado

Llavero con 4 funciones y lámpara. Incluye estuche y batería de botón.

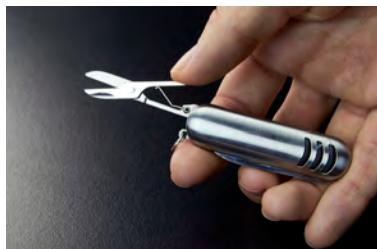
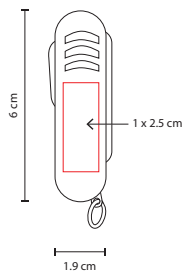

**Material:** Metal  
**Medida:** 1.9 x 6 cm  
**Área de Impresión:** 1 x 2.5 cm  
**Técnica de Impresión:** Láser / Pantógrafo / Serigrafía  
**Colores:** Plata

Contiene navaja, tijeras y destapador con punta de desarmador plano.

## HER 06

MINI NAVAJA BULLET

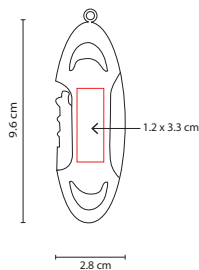

**Material:** Metal  
**Medida:** 2.8 x 9.6 cm  
**Área de Impresión:** 1.2 x 3.3 cm  
**Técnica de Impresión:** Pantógrafo / Serigrafía  
**Colores:** A/R/S

Navaja con 8 funciones. Incluye estuche.

## ST 010

NAVAJA BEETLE

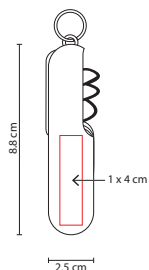

**Material:** Metal  
**Medida:** 2.5 x 8.8 cm  
**Área de Impresión:** 1 x 4 cm Navaja  
**Técnica de Impresión:** Pantógrafo / Serigrafía  
**Colores:** Plata

1 LED y 10 funciones. Incluye funda y batería de botón.

## ST 081

NAVAJA COLVILLE



HER 017

AROMATIZANTE  
AIR CLEAN

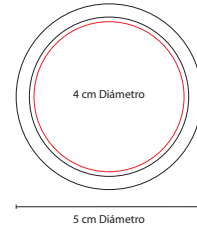

**Material:** Plástico  
**Medida:** 5 cm Diámetro  
**Área de Impresión:** 4 cm Diámetro  
**Técnica de Impresión:** Goteado en Resina / Serigrafía  
**Colores:** Blanco

Aromatizante para automóvil. Aroma limón. Con sujetador para rejilla de aire.

HER 01

MEDIDOR DE PRESIÓN  
DE AIRE PARA LLANTAS

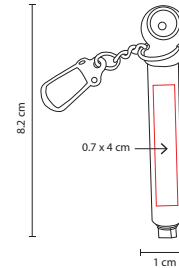

**Material:** Plástico  
**Medida:** 1 x 8.2 cm  
**Área de Impresión:** 0.7 x 4 cm  
**Técnica de Impresión:** Serigrafía  
**Colores:** Plata

Máxima medición 50 libras.

PRO 024

PORTA PLACA



N



B

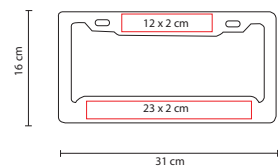

**Material:** Plástico  
**Medida:** 31 x 16 cm  
**Área de Impresión:** 23 x 2 cm  
**Técnica de Impresión:** Serigrafía  
**Colores:** B/N

Porta placa de plástico para automóvil.

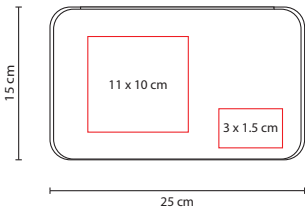

**Material:** Plástico / Poliéster / Metal  
**Medida:** 25 x 15 cm Estuche  
**Área de Impresión:** 11 x 10 cm Estuche / 3 x 1.5 cm Placa  
**Técnica de Impresión:** Láser en Placa Metálica / Serigrafía  
**Colores:** Negro

Contiene cables para pasar corriente, medidor de presión de aire, guantes, lámpara con 7 LEDs, impermeable, curitas, pinza y estuche. No incluye baterías.



## HER 020

SET DE EMERGENCIAS  
ANKER

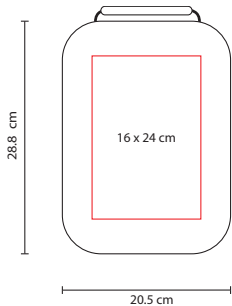

**Material:** Estuche de Loneta / Metal / Plástico  
**Medida:** 20.5 x 28.8 cm  
**Área de Impresión:** 16 x 24 cm  
**Técnica de Impresión:** Bordado / Serigrafía  
**Colores:** Negro

Contiene cables para pasar corriente, lámpara de 16 cm, pinzas, desarmador y puntas para desarmador. Lámpara no incluye baterías.



## HER 012

SET DE  
HERRAMIENTAS  
EMERGENCY



### HER 010

SET DE HERRAMIENTAS INDUSTRY

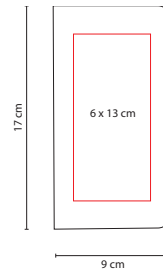

**Material:** Metal / Plástico / Poliéster  
**Medida:** 9 x 17 cm  
**Área de Impresión:** 6 x 13 cm  
**Técnica de Impresión:** Serigrafía  
**Colores:** Negro

Contiene mango y juego de puntas de desarmador, llaves allen, llaves para dados. Incluye estuche de tela.

### HER 03

SET DE HERRAMIENTAS ROADMASTER

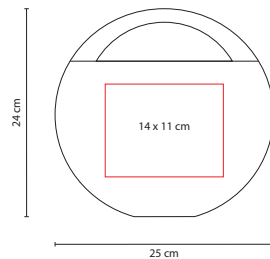

**Material:** Metal / Plástico  
**Medida:** 25 x 24 cm  
**Área de Impresión:** 14 x 11 cm  
**Técnica de Impresión:** Serigrafía  
**Colores:** Negro con Blanco Frosty

Contiene 2 pinzas (de punta y electricista), flexómetro de 1 m, 4 desarmadores de mano, 1 mango para 20 puntas de desarmadores diferentes. Incluye estuche.

### HER 08

SET DE HERRAMIENTAS CONRAD

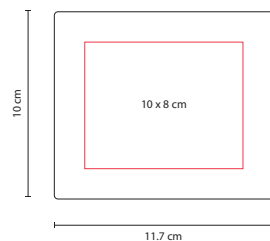
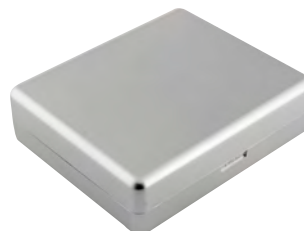

**Material:** Metal / Plástico  
**Medida:** 11.7 x 10 cm  
**Área de Impresión:** 10 x 8 cm  
**Técnica de Impresión:** Serigrafía  
**Colores:** Plata

Contiene 3 desarmadores de mano, flexómetro de 1 m, cúter, 10 puntas de desarmadores diferentes, dados y extensión. Incluye estuche.

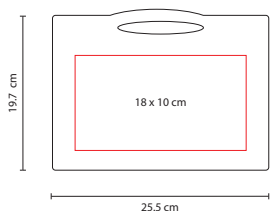

**Material:** Metal / Plástico  
**Medida:** 25.5 x 19.7 cm  
**Área de Impresión:** 18 x 10 cm  
**Técnica de Impresión:** Serigrafía  
**Colores:** Blanco con Negro

Contiene flexómetro de 2 m, desarmador plano y de cruz, martillo, verificador de corriente y pinzas. Incluye estuche.



## HER 014

SET DE  
HERRAMIENTAS  
HANCK

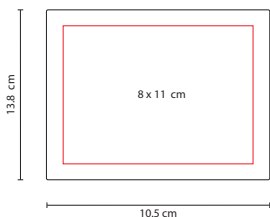

**Material:** Metal / Plástico  
**Medida:** 10.5 x 13.8 cm  
**Área de Impresión:** 8 x 11 cm  
**Técnica de Impresión:** Serigrafía  
**Colores:** Plata

Contiene flexómetro, desarmador, 3 llaves allen, 10 puntas para desarmador. Incluye estuche.



## HER 09

SET DE  
HERRAMIENTAS  
STATION

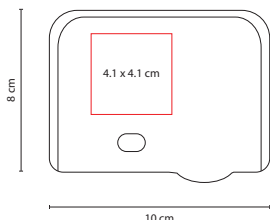
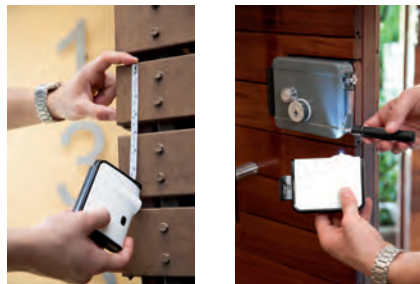

**Material:** Metal / Plástico  
**Medida:** 10 x 8 cm  
**Área de Impresión:** 4.1 x 4.1 cm  
**Técnica de Impresión:** Serigrafía  
**Colores:** Blanco con Negro

Contiene flexómetro de 3 m, nivel, desarmador con 4 puntas, extensión para desarmador, linterna de 1 LED. Incluye batería de botón.

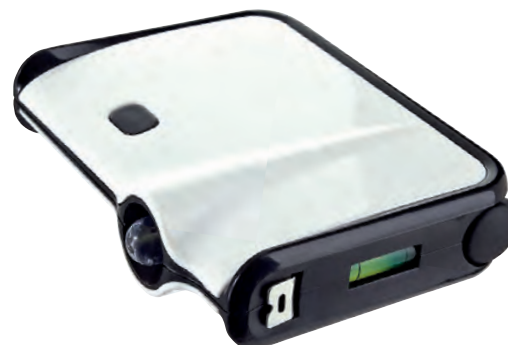

## HER 013

SET DE  
HERRAMIENTAS  
SENDEYRA



U 1226

BOLÍGRAFO  
DESARMADOR 4  
PUNTAS



A



R

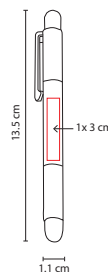

**Material:** Plástico  
**Medida:** 1.1 x 13.5 cm  
**Área de Impresión:** 1 x 3 cm  
**Técnica de Impresión:** Serigrafía  
**Colores:** A/B/R  
**Tinta:** Negra

B

Contiene 4 puntas diferentes de desarmador. Incluye estuche.



AT

HER 07

DESARMADOR 6  
PUNTAS CON LUZ  
FALCOR



RT



NT

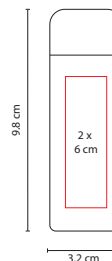

**Material:** Plástico / Metal  
**Medida:** 3.2 x 9.8 cm  
**Área de Impresión:** 2 x 6 cm  
**Técnica de Impresión:** Serigrafía  
**Colores:** AT/NT/RT

Contiene 6 diferentes puntas de desarmador, lámpara y clip. Incluye batería de botón.



RT

HER 02

DESARMADOR 6  
PUNTAS HIGHLANDER



AT



NT

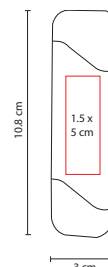

**Material:** Plástico  
**Medida:** 3 x 10.8 cm  
**Área de Impresión:** 1.5 x 5 cm  
**Técnica de Impresión:** Serigrafía  
**Colores:** AT/NT/RT

Contiene 6 diferentes puntas de desarmador (3 puntas de cruz y 3 puntas planas).



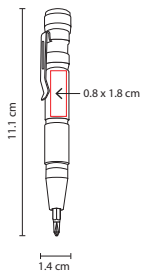

**Material:** Metal  
**Medida:** 1.4 x 11.1 cm  
**Área de Impresión:** 0.8 x 1.8 cm  
**Técnica de Impresión:** Láser / Pantógrafo / Serigrafía  
**Colores:** Gris Oxford Metalizado

Contiene 8 diferentes puntas de desarmador (4 puntas de cruz y 4 puntas planas). Incluye clip.

## HER 016

DESARMADOR DE 8 PUNTAS AZADY

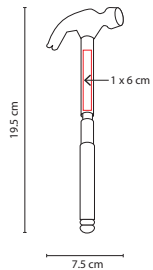

**Material:** Metal  
**Medida:** 7.5 x 19.5 cm  
**Área de Impresión:** 1 x 6 cm  
**Técnica de Impresión:** Pantógrafo / Serigrafía  
**Colores:** Plata

Contiene 4 desarmadores de distintos tamaños.

## HER 04

MARTILLO CON DESARMADORES TROY

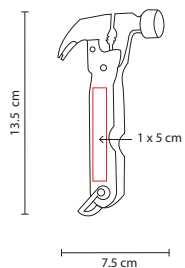

**Material:** Metal  
**Medida:** 7.5 x 13.5 cm  
**Área de Impresión:** 1 x 5 cm  
**Técnica de Impresión:** Pantógrafo / Serigrafía  
**Colores:** Plata

Contiene martillo, pinzas, navaja, tijeras, desarmador, cierra y lima. Incluye estuche.

## HER 05

MARTILLO THOR MULTIUSOS



LIG 001

ENCENDEDOR MYGRA

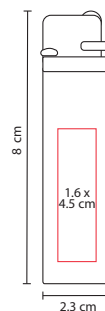

**Material:** Plástico  
**Medida:** 2.3 x 8 cm  
**Área de Impresión:** 1.6 x 4.5 cm  
**Técnica de Impresión:** Serigrafía  
**Colores:** Blanco

Encendedor desechable. Flama regulable.

98650

HIELERA MACARONI



R



A



N

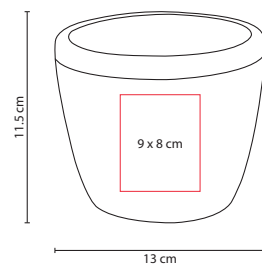

**Material:** Acero Inoxidable / Plástico  
**Medida:** 13 x 11.5 cm  
**Área de Impresión:** 9 x 8 cm  
**Técnica de Impresión:** Serigrafía /  
 Tampografía  
**Colores:** A/N/R

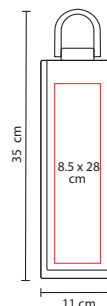
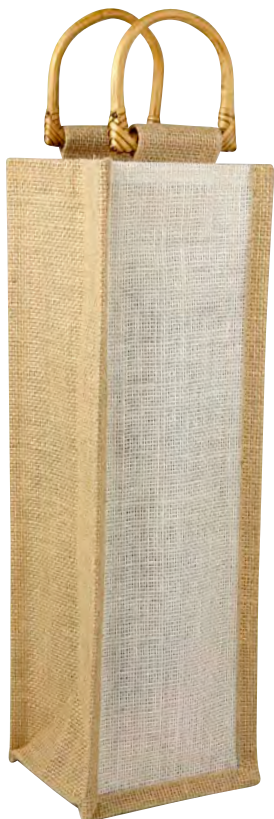

86400

ESTUCHE PARA VINOS  
PALERMO

**Material:** Yute  
**Medida:** 11 x 35 cm  
**Área de Impresión:** 8,5 x 28 cm  
**Técnica de Impresión:** Serigrafía  
**Colores:** Blanco con Beige

Interior plastificado. Agarraderas de madera.

851091

SET PARA VINOS  
MEDITERRANEO

Cortador



Arillo



Termómetro

Sacacorchos con  
navaja

Stopper

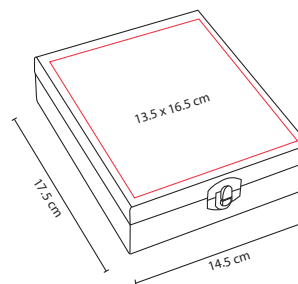

**Material:** Madera / Metal  
**Medida:** 14,5 x 17,5 cm  
**Área de Impresión:** 13,5 x 16,5 cm  
**Técnica de Impresión:** Láser / Serigrafía  
**Colores:** Madera

Incluye sacacorchos con navaja, stopper, arillo, termómetro y cortador.

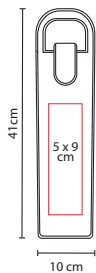

86300

ESTUCHE PARA VINOS  
MOLORI

**Material:** Curpiel  
**Medida:** 10 x 41 cm  
**Área de Impresión:** 5 x 9 cm  
**Técnica de Impresión:** Láser / Serigrafía  
**Colores:** Negro

Bolsa curpiel porta botellas con broche metálico imantado.

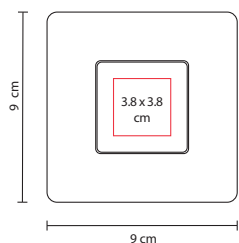

KTC 013

SET DE PORTAVASOS  
SILVER

**Material:** EVA / Metal / Plástico  
**Medida:** 9 x 9 cm  
**Área de Impresión:** 3.8 x 3.8 cm  
**Técnica de Impresión:** Láser / Serigrafía  
**Colores:** Negro

Incluye 4 porta vasos.



Arillo      Sacacorchos con navaja      Stopper      Boquilla

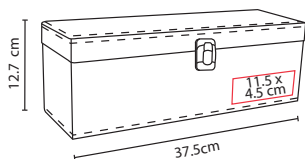

98641

SET PARA VINOS  
PAMPLONA



**Material:** Curpiel / Metal / Terciopelo  
**Medida:** 37.5 x 12.7 cm  
**Área de Impresión:** 11.5 x 4.5 cm  
**Técnica de Impresión:** Láser / Serigrafía  
**Colores:** Chocolate

Incluye sacacorchos con navaja, stopper, boquilla y arillo. No incluye botella.

851056

SET PARA VINOS  
CABERNET

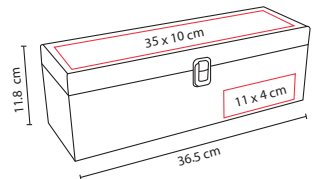

**Material:** Madera / Metal  
**Medida:** 36.5 x 11.8 cm  
**Área de Impresión:** 35 x 10 cm  
**Técnica de Impresión:** Láser / Serigrafía  
**Colores:** Negro

Incluye arillo, stopper, boquilla y sacacorchos con navaja.

98509

SET PARA VINOS  
CHATEAU BLANC



Arillo



Termómetro



Sacacorchos  
con navaja



Boquilla

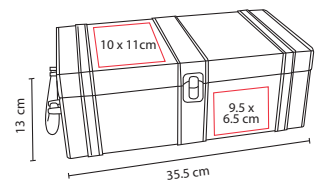

**Material:** Curpiel / Metal  
**Medida:** 35.5 x 13 cm  
**Área de Impresión:** 9.5 x 6.5 cm  
**Técnica de Impresión:** Láser / Serigrafía  
**Colores:** Negro

Espacio para botella y dos copas (no incluidas) de 8 x 16 cm con sujetadores. Incluye sacacorchos con navaja, termómetro, boquilla y arillo.



87200

LICORERA BRISTOL

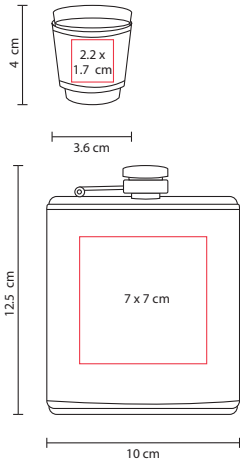

**Material:** Acero Inoxidable / Curpiel  
**Medida:** 10 x 12.5 cm Licorera / 3.6 x 4 cm vasos  
**Área de Impresión:** 7 x 7 cm Licorera / 2.2 x 1.7 cm vasos  
**Técnica de Impresión:** Láser / Serigrafía / Tampografía / Termograbado  
**Colores:** Negro  
**Capacidad:** 196 ml

Incluye licorera, 2 vasos metálicos, embudo y caja de regalo.



86500

ESTUCHE PARA VINOS BORGONA

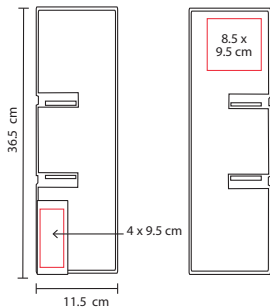

**Material:** Curpiel  
**Medida:** 11.5 x 36.5 cm  
**Área de Impresión:** 4 x 9.5 cm Placa  
**Técnica de Impresión:** Láser / Serigrafía  
**Colores:** Negro

Cava para 5 botellas.

JM 021

CUBILETE KENTAUR

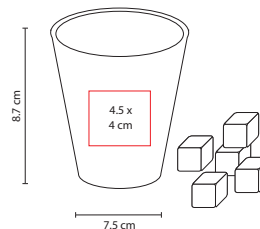

**Material:** Curpiel  
**Medida:** 7.5 x 8.7 cm  
**Área de Impresión:** 4.5 x 4 cm  
**Técnica de Impresión:** Serigrafía  
**Colores:** Negro con Gris

Incluye 5 dados.

JM 025

JENGA DRINKING TOWER

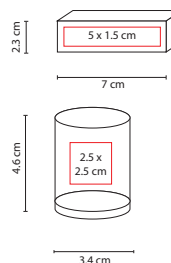

**Material:** Madera  
**Medida:** 7 x 2.3 cm Ficha / 3.4 x 4.6 cm Vaso  
**Área de Impresión:** 5 x 1.5 cm Ficha / 2.5 x 2.5 cm Vaso  
**Técnica de Impresión:** Láser / Serigrafía  
**Colores:** Madera

Incluye 60 piezas de madera, estuche y 4 vasos de cristal.

JM 008

MINI BOLICHE ROYSTON

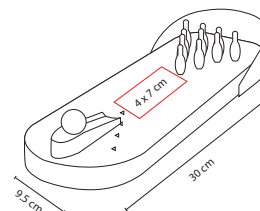
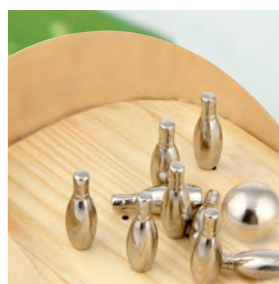
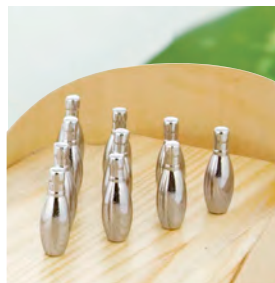

**Material:** Madera / Metal  
**Medida:** 9.5 x 30 cm  
**Área de Impresión:** 4 x 7 cm  
**Técnica de Impresión:** Láser / Serigrafía  
**Colores:** Cromo y Madera

Incluye 10 bolos y 1 bola.





JM 020

JUEGO DE AJEDREZ

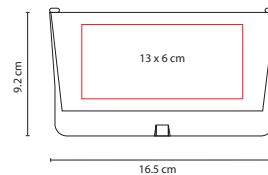
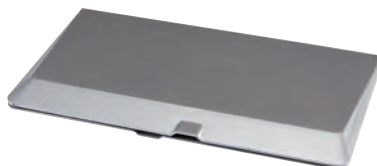

**Materia:** Plástico / Metal  
**Medida:** 16.5 x 9.2 cm  
**Área de Impresión:** 13 x 6 cm  
**Técnica de Impresión:** Serigrafía  
**Colores:** Plata

Con tablero y fichas imantadas.

JM 002

JUEGO DE DOMINÓ COMPACTO

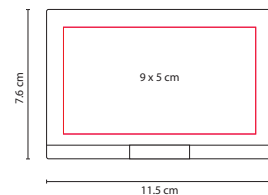

**Materia:** Plástico / Metal  
**Medida:** 11.5 x 7.6 cm  
**Área de Impresión:** 9 x 5 cm  
**Técnica de Impresión:** Pantógrafo / Serigrafía  
**Colores:** Plata

Incluye estuche de aluminio con 28 piezas.

JM 001

JUEGO DE DOMINÓ

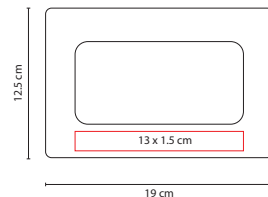

**Materia:** Estuche Aluminio / Fichas Plástico  
**Medida:** 19 x 12.5 cm  
**Área de Impresión:** 13 x 1.5 cm  
**Técnica de Impresión:** Pantógrafo / Serigrafía  
**Colores:** Estuche Plata / Fichas Blancas

Incluye estuche de aluminio con 28 piezas.

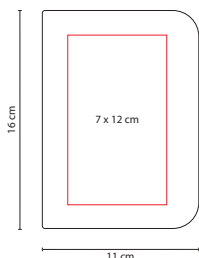

**Material:** Curpiel  
**Medida:** 11 x 16 cm  
**Área de Impresión:** 7 x 12 cm  
**Técnica de Impresión:** Serigrafía  
**Colores:** Negro

Estuche de curpiel con 2 barajas plastificadas, libreta y bolígrafo.



## JM 009

JUEGO DE CARTAS ROYAL



Comparativo JM 004 con JM 014

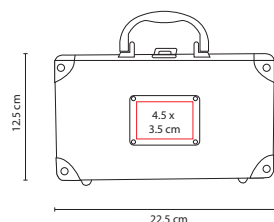

**Material:** Metal / Plástico  
**Medida:** 22.5 x 12.5 cm  
**Área de Impresión:** 4.5 x 3.5 cm  
**Técnica de Impresión:** Pantógrafo / Serigrafía  
**Colores:** Plata

Incluye 50 fichas, 2 barajas plásticas, 1 ficha de dealer y llaves.



## JM 014

MINI MALETÍN DE POKER LUCKY

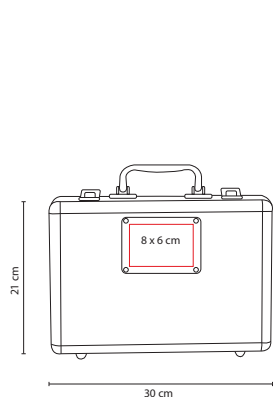

**Material:** Metal / Plástico  
**Medida:** 30 x 21 cm  
**Área de Impresión:** 8 x 6 cm  
**Técnica de Impresión:** Pantógrafo / Serigrafía  
**Colores:** Plata

Incluye 200 fichas, 2 barajas plastificadas, 5 dados, 1 ficha de dealer y llaves.



## JM 004

MALETÍN DE POKER BELLAGIO



JM 010

JUEGO DE MESA  
BACKGAMMON

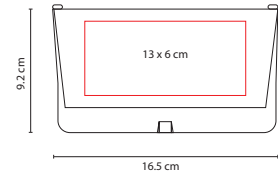
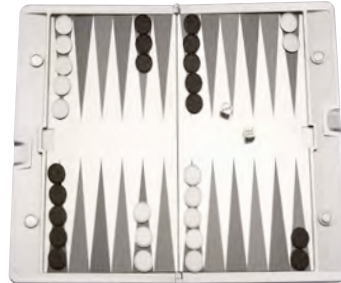
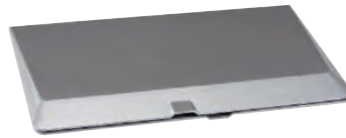

**Materia:** Plástico / Metal  
**Medida:** 16.5 x 9.2 cm  
**Área de Impresión:** 13 x 6 cm  
**Técnica de Impresión:** Serigrafía  
**Colores:** Plata

Incluye dados, tablero y fichas imantadas.

JM 005

MINI CANASTA DE  
BASKET TARGET

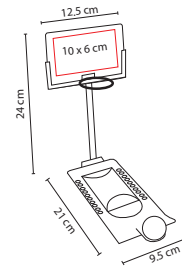

**Materia:** Aluminio / Plástico  
**Medida:** 9.5 x 24 cm  
**Área de Impresión:** 10 x 6 cm Tablero  
**Técnica de Impresión:** Serigrafía  
**Colores:** Plata

Incluye pelota de plástico.

JM 015

JUEGO DE DARDOS Y  
DECISION MAKER

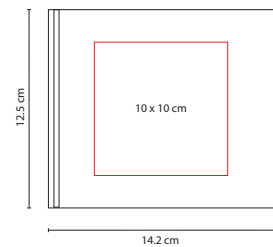

**Materia:** Aluminio  
**Medida:** 14.2 x 12.5 cm  
**Área de Impresión:** 10 x 10 cm  
**Técnica de Impresión:** Pantógrafo / Serigrafía  
**Colores:** Plata

Incluye 6 dardos.



JM 018

MINI GOLF PUTTER

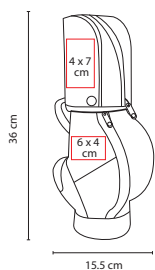

**Material:** Bastón de Aluminio / Estuche de Curpiel  
**Medida:** 15.5 x 36 cm  
**Área de Impresión:** 4 x 7 cm Tapa  
**Técnica de Impresión:** Bordado / Láser / Serigrafía  
**Colores:** Negro

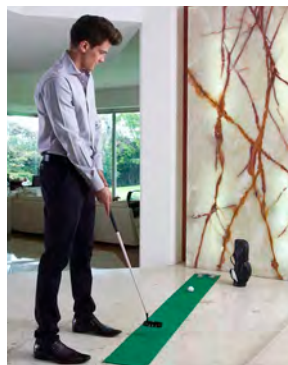

Incluye bastón, tapete en color verde, hoyo y pelota de golf. El estuche cuenta con dos bolsas.

JM 035

JUEGO MINI GOLF

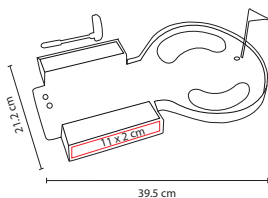

**Material:** Plástico / Cristal  
**Medida:** 39.5 X 21.2 cm  
**Área de Impresión:** 11 x 2 cm  
**Técnica de Impresión:** Serigrafía  
**Colores:** Verde

Incluye 6 vasos de cristal, 2 balines, 2 palos de golf y banderín.

JM 030

RULETA MONTECARLO

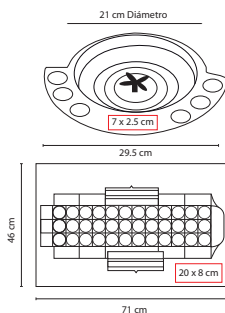

**Material:** Cristal / Plástico  
**Medida:** 71 x 46 cm  
**Área de Impresión:** 20 x 8 cm  
**Técnica de Impresión:** Serigrafía  
**Colores:** Negro

Incluye tapete, 6 vasos y 2 balines.

## SOC 032

BALÓN GALAXI



A



R



S

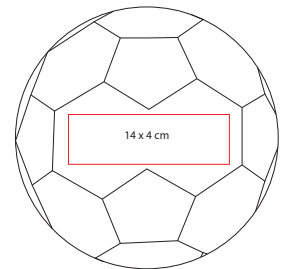
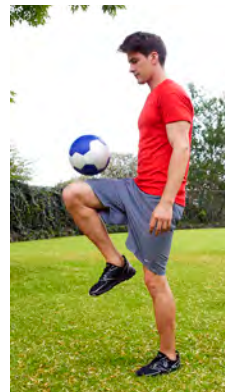

**Material:** EVA / PVC  
**Medida:** No. 5  
**Área de Impresión:** 14 x 4 cm  
**Técnica de Impresión:** Serigrafía / Tampografía  
**Colores:** A/R/S

Cámara blader rubber, 30-32 gajos. Peso 380 gr. Cosido a máquina. 2 capas. Nivel máximo de presión 6-8 libras.

## SOC 400

MINI BALÓN PREMIER



N



Comparativo del  
SOC 400 y el SOC 500

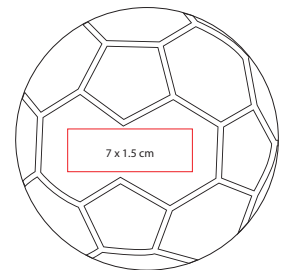

**Material:** EVA / PVC  
**Medida:** No. 2  
**Área de Impresión:** 7 x 1.5 cm  
**Técnica de Impresión:** Serigrafía / Tampografía  
**Colores:** Blanco y Negro con Líneas Plateadas

Cámara blader rubber, 30-32 gajos. Peso 150 gr. Cosido a máquina. 1 capa. Nivel máximo de presión 2-3 libras.

## SOC 500

BALÓN PREMIER



R



A



N

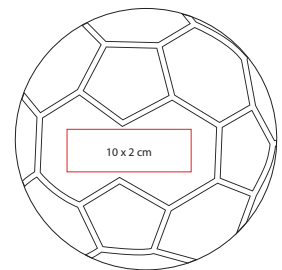

**Material:** EVA / PVC  
**Medida:** No. 5  
**Área de Impresión:** 10 x 2 cm  
**Técnica de Impresión:** Serigrafía / Tampografía  
**Colores:** A/N/R

Cámara blader rubber, 30-32 gajos. Peso 380 gr. Cosido a máquina. 2 capas. Nivel máximo de presión 6-8 libras.

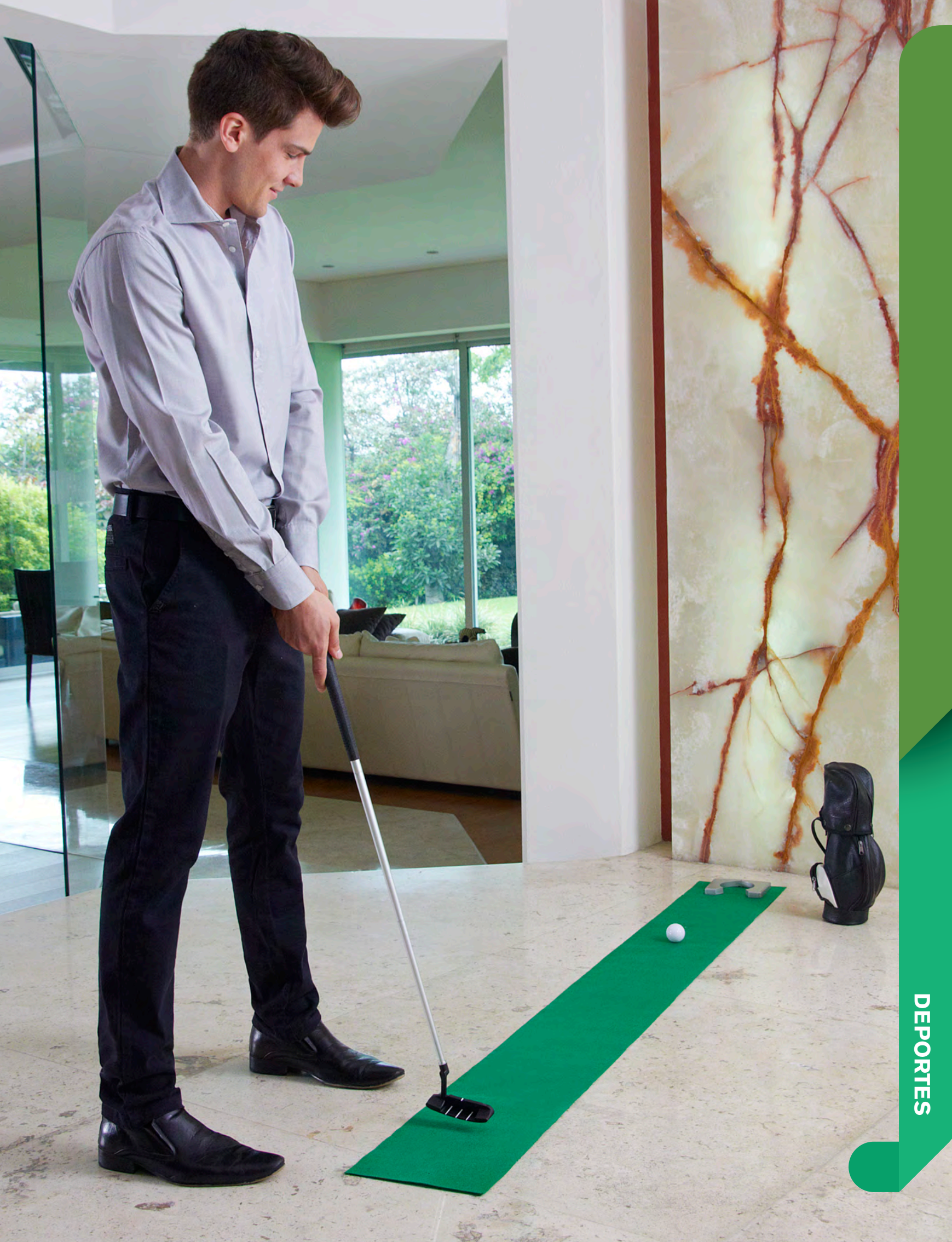

DEPORTES

GLF 05

CLIP CON MARCADOR DE BOLAS WINNER

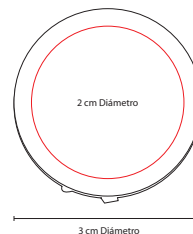

**Material:** Metal  
**Medida:** 3 cm Diámetro  
**Área de Impresión:** 2 cm Diámetro  
**Técnica de Impresión:** Láser / Pantógrafo / Serigrafía  
**Colores:** Plata

Marcador magnético de pelota con velcro para los guantes.

GLF 07

SACADIVOT PINZÓN

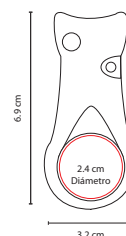
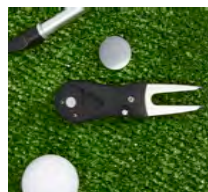

**Material:** Metal / Rubber  
**Medida:** 3.2 x 6.9 cm  
**Área de Impresión:** 2.4 cm Diámetro  
**Técnica de Impresión:** Goteado en Resina  
**Colores:** Negro

Incluye marcador de pelota.

GLF 08

GANCHO CON MARCADOR DE BOLAS HIT

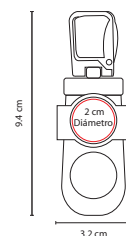

**Material:** Curpiel / Metal  
**Medida:** 3.2 x 9.4 cm  
**Área de Impresión:** 2 cm Diámetro  
**Técnica de Impresión:** Láser / Pantógrafo / Serigrafía  
**Colores:** Negro

Marcador magnético de pelota con velcro para los guantes.

GLF 06

SET DE GOLF BIRIDIE

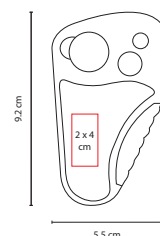

**Material:** Acero Inoxidable  
**Medida:** 5.5 x 9.2 cm  
**Área de Impresión:** 2 x 4 cm  
**Técnica de Impresión:** Láser / Pantógrafo / Serigrafía  
**Colores:** Plata

Incluye un contador de golpes, un destapador, un saca divot, un marcador de pelota, un cepillo y un ajustador de taquetes.



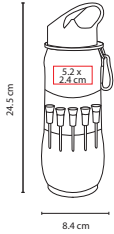

## GLF 04

TERMO BOGEY



**Material:** Acero Inoxidable  
**Medida:** 8.4 x 24.5 cm  
**Área de Impresión:** 5.2 x 2.4 cm  
**Técnica de Impresión:** Tampografía  
**Colores:** Blanco con Negro  
**Capacidad:** 750 ml

Incluye cintillo de curpiel, un gancho y 5 tees.

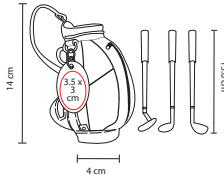

## GLF 01

RELOJ Y  
PORTAPLUMAS GOLF



**Material:** Curpiel / Metal  
**Medida:** 4 x 13 cm  
**Área de Impresión:** 3.5 x 3 cm  
**Técnica de Impresión:** Pantógrafo / Serigrafía  
**Colores:** Blanco con Negro

Incluye bolígrafos en forma de palos de golf, tinta negra, roja y azul, placa metálica para impresión. Incluye baterías.

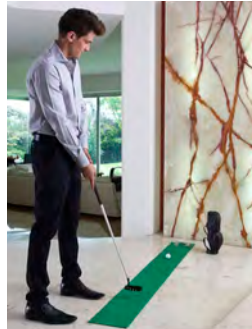
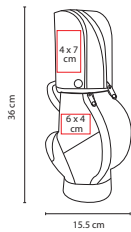

## JM 018

MINI GOLF PUTTER



**Material:** Bastón de Aluminio / Estuche de Curpiel  
**Medida:** 15.5 x 36 cm  
**Área de Impresión:** 4 x 7 cm Tapa  
**Técnica de Impresión:** Bordado / Láser / Serigrafía  
**Colores:** Negro

Incluye bastón, tapete en color verde, hoyo y pelota de golf. El estuche cuenta con dos bolsas.

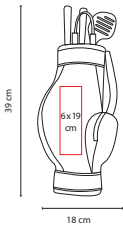

## BBQ 004

SET BBQ GOLF



**Material:** Acero Inoxidable / Curpiel  
**Medida:** 18 x 39 cm  
**Área de Impresión:** 6 x 19 cm  
**Técnica de Impresión:** Serigrafía / Termograbado  
**Colores:** Blanco con Negro

Incluye dos compartimentos, espátula, tenedor para BBQ, pinzas y cuchillo.

SIN 029

HIELERA COOL BREAKS



R



N



A

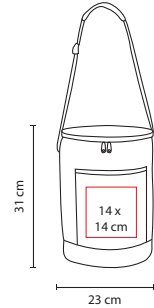

**Material:** Nylon  
**Medida:** 23 x 31 cm  
**Área de Impresión:** 14 x 14 cm  
**Técnica de Impresión:** Serigrafía  
**Colores:** A/N/R

Interior plastificado impermeable. Incluye bolsa frontal y bolsa posterior de red.

SIN 007

HIELERA 2 SIX



A



N



R



B

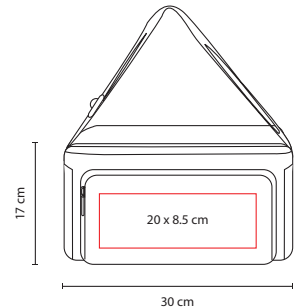

**Material:** Nylon  
**Medida:** 30 x 17 cm  
**Área de Impresión:** 20 x 8.5 cm  
**Técnica de Impresión:** Serigrafía  
**Colores:** A/B/N/R

Interior metalizado plastificado e impermeable. Bolsa frontal.





A

SIN 450

LONCHERA ACTIVE



R



N

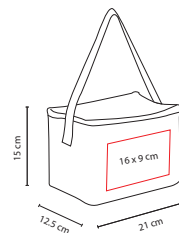

**Material:** Nylon  
**Medida:** 21 x 15 cm  
**Área de Impresión:** 16 x 9 cm  
**Técnica de Impresión:** Serigrafía  
**Colores:** A/N/R

Interior metalizado.



Y

SIN 057

HIELERA KOSTA



R



N



V



O



A

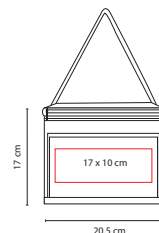

**Material:** Poliéster  
**Medida:** 20.5 x 17 cm  
**Área de Impresión:** 17 x 10 cm  
**Técnica de Impresión:** Serigrafía  
**Colores:** A/N/O/R/V/Y

Interior plastificado impermeable. Incluye bolsa frontal.



N

SIN 003

HIELERA 1 SIX



V



A



R

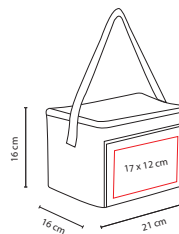

**Material:** Nylon  
**Medida:** 21 x 16 cm  
**Área de Impresión:** 17 x 12 cm  
**Técnica de Impresión:** Serigrafía  
**Colores:** A/N/R/V

Interior plastificado impermeable. Incluye bolsa frontal.



R

SIN 080

HIELERA BARCELÓ



Y



O



V



A



N



B

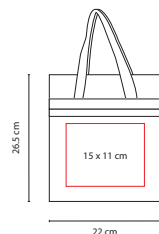

**Material:** Non Woven  
**Medida:** 22 x 26.5 cm  
**Área de Impresión:** 15 x 11 cm  
**Técnica de Impresión:** Serigrafía  
**Colores:** A/B/N/O/R/V/Y

Interior plastificado impermeable. Broche de velcro.

KTC 008

LONCHERA BENTO

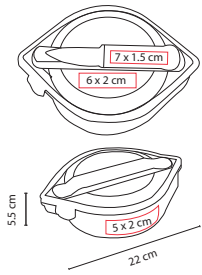

A



R



O



B



V

**Material:** Plástico  
**Medida:** 22 x 5,5 cm  
**Área de Impresión:** 5 x 2 cm  
**Técnica de Impresión:** Serigrafía  
**Colores:** A/B/O/R/V

Incluye cuchara, tenedor y cuchillo. 3 Compartimentos.

KTC 007

PORTAVIANDAS BEYLA

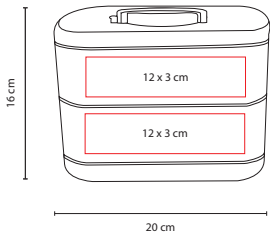

A



R

**Material:** Plástico  
**Medida:** 20 x 16 cm  
**Área de Impresión:** 12 x 3 cm  
**Técnica de Impresión:** Serigrafía  
**Colores:** A/R

Incluye tenedor, cuchara y cuatro recipientes.

KTC 015

PORTAVIANDAS SENYA

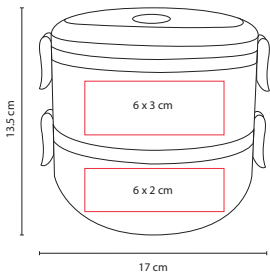

**Material:** Plástico / Acero Inoxidable  
**Medida:** 17 x 13,5 cm  
**Área de Impresión:** 6 x 3 cm  
**Técnica de Impresión:** Serigrafía / Tampografía  
**Colores:** Blanco

Incluye dos recipientes para alimentos. Compartimiento superior para líquidos e inferior para sólidos. Con agarradera doble, válvula de silicón y broches sujetadores.



SIN 131

BOLSA CIMBOA



V



B



N



O



Y



A



R

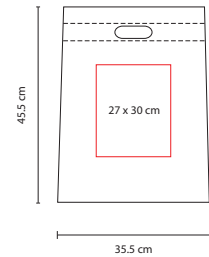

**Material:** Non Woven  
**Medida:** 35.5 x 45.5 cm  
**Área de Impresión:** 27 x 30 cm  
**Técnica de Impresión:** Serigrafía  
**Colores:** A/B/N/O/R/V/Y

Bolsa sellada a calor.

SIN 141

BOLSA CART BAG

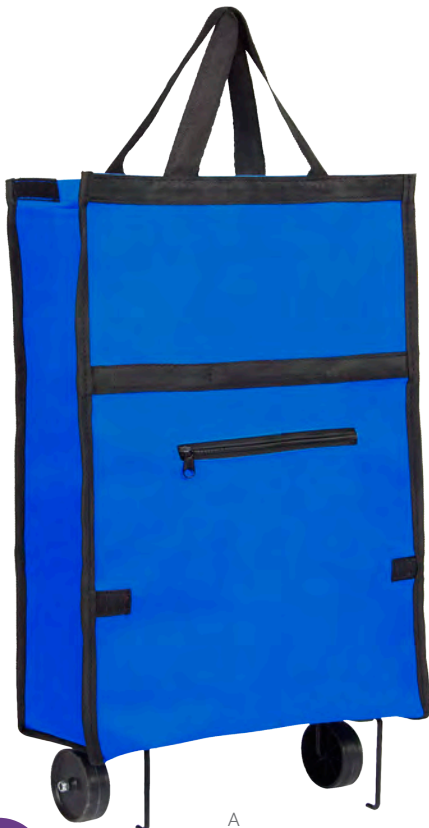

A



R



N

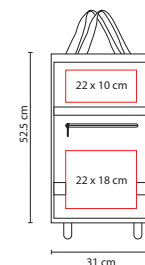

**Material:** Poliéster  
**Medida:** 31 x 52.5 cm  
**Área de Impresión:** 22 x 18 cm  
**Técnica de Impresión:** Bordado / Serigrafía  
**Colores:** A/N/R

Incluye bolsa frontal y principal.



SIN 043

BOLSA TOLEDO



O



A



R



V



Y



N



B

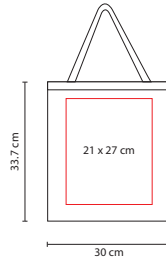

**Material:** Non Woven  
**Medida:** 30 x 33.7 cm  
**Área de Impresión:** 21 x 27 cm  
**Técnica de Impresión:** Serigrafía  
**Colores:** A/B/N/O/R/V/Y

Bolsa sin fuelle.

SIN 022

BOLSA RIOJA



V



O



N



Y



A



R



B

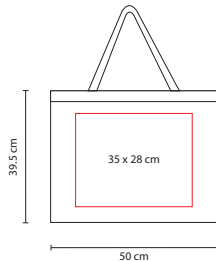

**Material:** Non Woven  
**Medida:** 50 x 39.5 cm  
**Área de Impresión:** 35 x 28 cm  
**Técnica de Impresión:** Serigrafía  
**Colores:** A/B/N/O/R/V/Y

Bolsa sin fuelle.

SIN 041

BOLSA SHOPPER



R



A



O



V



N

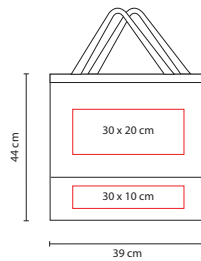

**Material:** Non Woven  
**Medida:** 39 x 44 cm  
**Área de Impresión:** 30 x 20 cm  
**Técnica de Impresión:** Serigrafía  
**Colores:** A/N/O/R/V

Bolsa con fuelle.



SIN 047

BOLSA CARNAVAL

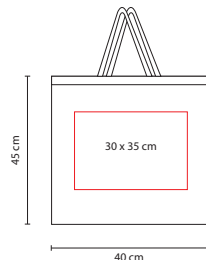

**Material:** Non Woven Metalizado  
**Medida:** 40 x 45 cm  
**Área de Impresión:** 30 x 35 cm  
**Técnica de Impresión:** Serigrafía  
**Colores:** A/D/R/S/V

Bolsa con fuelle metalizada.



A



R



V



S



D

SIN 175

BOLSA MORAB

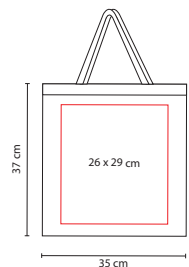

**Material:** Non Woven  
**Medida:** 35 x 37 cm  
**Área de Impresión:** 26 x 29 cm  
**Técnica de Impresión:** Serigrafía  
**Colores:** A/B/N/R

Bolsa plegable con botón.



B



N



R



A

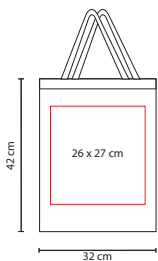

**Material:** Non Woven  
**Medida:** 32 x 42 cm  
**Área de Impresión:** 26 x 27 cm  
**Técnica de Impresión:** Serigrafía  
**Colores:** A/B/BE/C/N/O/R/V

Bolsa con fuelle.

SIN 230

BOLSA ECOLÓGICA ENVIRONMENT



N



B



A



O



V



C



R



BE

SIN 081

BOLSA ROCHEL



P



O



N



R



A

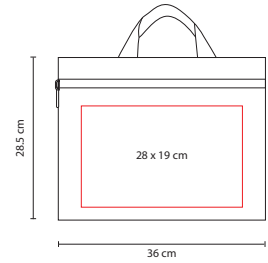

**Material:** 100% Algodón  
**Medida:** 36 x 28,5 cm  
**Área de Impresión:** 28 x 19 cm  
**Técnica de Impresión:** Bordado / Serigrafía  
**Colores:** A/N/O/P/R

Capacidad para laptop 15".

SIN 220

BOLSA-MOCHILA LORETTO

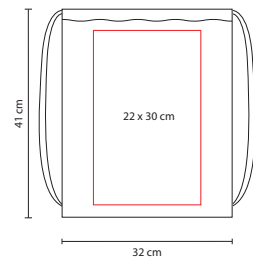

**Material:** 100% Algodón  
**Medida:** 32 x 41 cm  
**Área de Impresión:** 22 x 30 cm  
**Técnica de Impresión:** Serigrafía  
**Colores:** Beige

SIN 210

BOLSA COTTON SLIM



V



A



R



O



BE



P



N

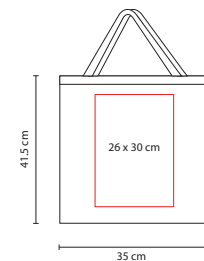

**Material:** 100% Algodón  
**Medida:** 35 x 41,5 cm  
**Área de Impresión:** 26 x 30 cm  
**Técnica de Impresión:** Serigrafía  
**Colores:** A/BE/N/O/P/R/V

Bolsa sin fuelle.

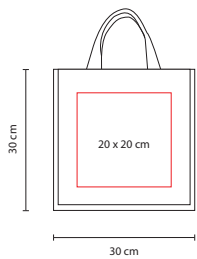

## SIN 112

BOLSA SPRING



**Material:** Yute  
**Medida:** 30 x 30 cm  
**Área de Impresión:** 20 x 20 cm  
**Técnica de Impresión:** Bordado / Serigrafía  
**Colores:** Natural

Interior plastificado.

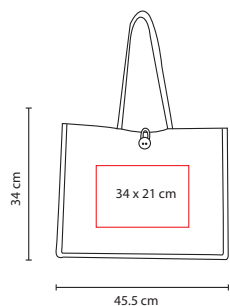

## SIN 114

BOLSA WINTER



**Material:** Yute  
**Medida:** 45.5 x 34 cm  
**Área de Impresión:** 34 x 21 cm  
**Técnica de Impresión:** Bordado / Serigrafía  
**Colores:** Natural

Interior plastificado. Botón de madera al frente.

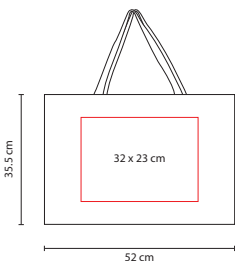

## SIN 113

BOLSA FALL



**Material:** Yute  
**Medida:** 52 x 35.5 cm  
**Área de Impresión:** 32 x 23 cm  
**Técnica de Impresión:** Bordado / Serigrafía  
**Colores:** Natural

Bolsa con fuelle.

SIN 235  
BOLSA-MOCHILA  
ASTORGA



A



R



B



Y



V



N



O

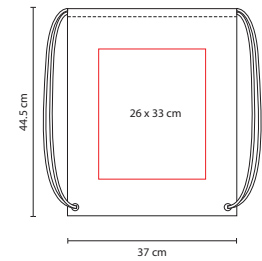

**Material:** Non Woven  
**Medida:** 37 x 44.5 cm  
**Área de Impresión:** 26 x 33 cm  
**Técnica de Impresión:** Serigrafía  
**Colores:** A/B/N/O/R/V/Y

SIN 021  
BOLSA-MOCHILA  
PRISMA



Y



A



B



N



P



V



R



O

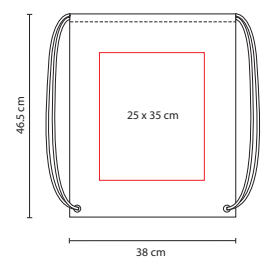

**Material:** Nylon  
**Medida:** 38 x 46.5 cm  
**Área de Impresión:** 25 x 35 cm  
**Técnica de Impresión:** Serigrafía  
**Colores:** A/B/N/O/P/R/V/Y



## SIN 088

BOLSA-MOCHILA  
ARECA



V



P



R



Y



A



O

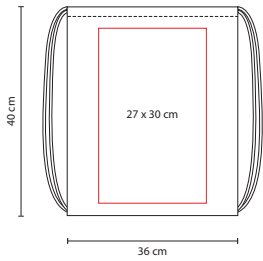

**Material:** Yute  
**Medida:** 36 x 40 cm  
**Área de Impresión:** 27 x 30 cm  
**Técnica de Impresión:** Serigrafía  
**Colores:** A/O/P/R/V/Y

## SIN 019

BOLSA-MOCHILA  
SURF



N



O



B



V



Y



R



A

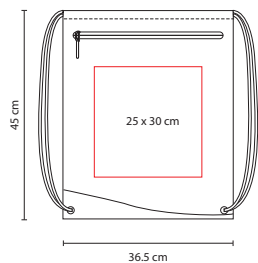

**Material:** Nylon  
**Medida:** 36.5 x 45 cm  
**Área de Impresión:** 25 x 30 cm  
**Técnica de Impresión:** Serigrafía  
**Colores:** A/B/N/O/R/V/Y

Incluye bolsa frontal.

SIN 130  
BOLSA-MOCHILA YAIK

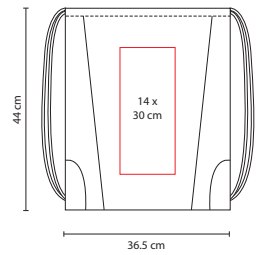

**Material:** Non Woven / Poliéster  
**Medida:** 36.5 x 44 cm  
**Área de Impresión:** 14 x 30 cm  
**Técnica de Impresión:** Serigrafía  
**Colores:** A/O/R/V

Con cordón sujetador.

SIN 054  
BOLSA BRETÓN

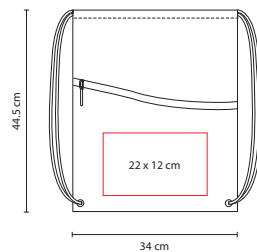

**Material:** Non Woven  
**Medida:** 34 x 44.5 cm  
**Área de Impresión:** 22 x 12 cm  
**Técnica de Impresión:** Serigrafía  
**Colores:** A/B/O/R/V

Incluye bolsa frontal y aditamento especial para audífonos. No incluye audífonos.



A

SIN 055

BOLSA LENA



Y



R



V



O

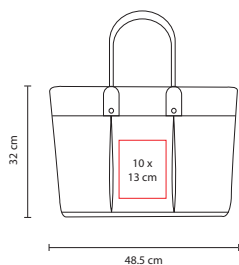

**Material:** Canvas  
**Medida:** 48,5 x 32 cm  
**Área de Impresión:** 10 x 13 cm  
**Técnica de Impresión:** Bordado  
**Colores:** A/O/R/V/Y



P

SIN 065

BOLSA MALLORQUÍN



V



A



O



R

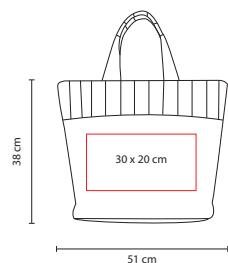

**Material:** Yute  
**Medida:** 51 x 38 cm  
**Área de Impresión:** 30 x 20 cm  
**Técnica de Impresión:** Serigrafía  
**Colores:** A/O/P/R/V

SIN 087

BOLSA ALMEZ



V



O



N



R



A

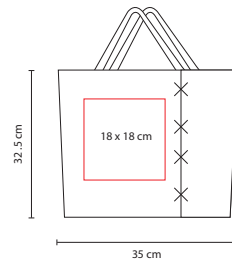

**Material:** Yute  
**Medida:** 35 x 32.5 cm  
**Área de Impresión:** 18 x 18 cm  
**Técnica de Impresión:** Serigrafía  
**Colores:** A/N/O/R/V

Bolsa con fuelle.

SIN 901

BOLSA ISSIA



O



A



R

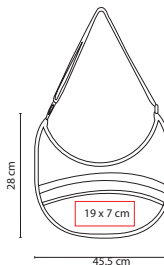
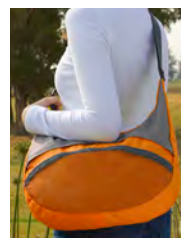

**Material:** Poliéster  
**Medida:** 45.5 x 28 cm  
**Área de Impresión:** 19 x 7 cm  
**Técnica de Impresión:** Bordado / Serigrafía  
**Colores:** A/O/R

Bolsa principal y bolsa frontal de malla. Agarradera posterior para colocar en trolley.

SIN 185

BOLSA MESHY



A



N



R

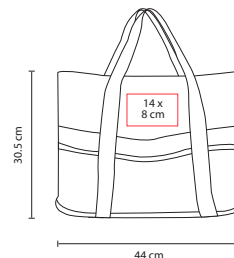

**Material:** Malla / Poliéster  
**Medida:** 44 x 30.5 cm  
**Área de Impresión:** 14 x 8 cm  
**Técnica de Impresión:** Bordado / Serigrafía  
**Colores:** A/N/R

Incluye 3 bolsas frontales y 3 posteriores.





SIN 062

BOLSA TORBA



N



R



O



N



V

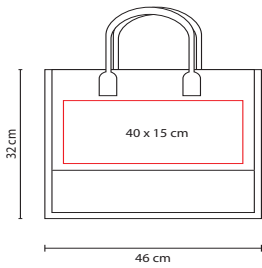

**Material:** Yute  
**Medida:** 46 x 32 cm  
**Área de Impresión:** 40 x 15 cm  
**Técnica de Impresión:** Serigrafía  
**Colores:** A/N/O/R/V

Bolsa con fuelle. Interior plastificado.



SIN 077

BOLSA TRANDY



N



V



R



O



A

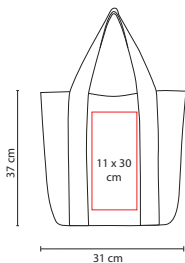

**Material:** Yute  
**Medida:** 31 x 37 cm  
**Área de Impresión:** 11 x 30 cm  
**Técnica de Impresión:** Serigrafía  
**Colores:** A/N/O/R/V

Interior plastificado. Broche velcro.

SIN 037

MOCHILA GOCH



R



N



A

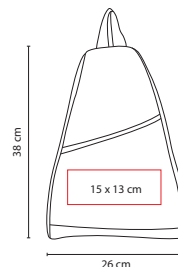

**Material:** Nylon  
**Medida:** 26 x 38 cm  
**Área de Impresión:** 15 x 13 cm  
**Técnica de Impresión:** Serigrafía  
**Colores:** A/N/R

Bolsa principal.

SIN 402

MOCHILA PARIS



N



A



V



O



R

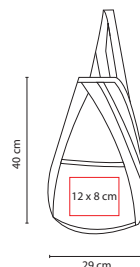

**Material:** Non Woven  
**Medida:** 29 x 40 cm  
**Área de Impresión:** 12 x 8 cm  
**Técnica de Impresión:** Serigrafía  
**Colores:** A/N/O/R/V

Bolsa principal y frontal.

SIN 121

MOCHILA TERRIER



O



R



N



A



V

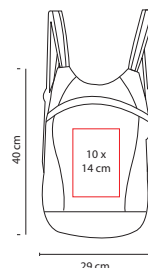

**Material:** Nylon  
**Medida:** 29 x 40 cm  
**Área de Impresión:** 10 x 14 cm  
**Técnica de Impresión:** Serigrafía  
**Colores:** A/N/O/R/V

Bolsa principal.



SIN 038

MOCHILA EUROPE



V



O



R



A



Y

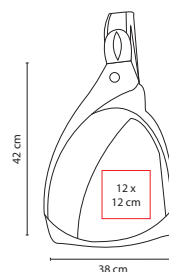

**Material:** Poliéster / Nylon  
**Medida:** 38 x 42 cm  
**Área de Impresión:** 12 x 12 cm  
**Técnica de Impresión:** Bordado / Serigrafía  
**Colores:** A/O/R/V/Y

Aditamento especial para audífonos.

SIN 060

MOCHILA ANTARA



R



A



V



S



O

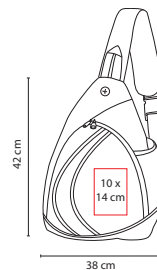

**Material:** Poliéster  
**Medida:** 38 x 42 cm  
**Área de Impresión:** 10 x 14 cm  
**Técnica de Impresión:** Bordado / Serigrafía  
**Colores:** A/O/R/S/V

Aditamento especial para audífonos. Bolsa para celular.

SIN 026

MOCHILA ACCENT



N



A



R

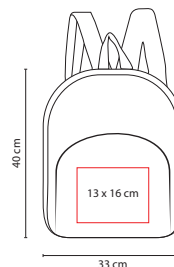

**Material:** Poliéster  
**Medida:** 33 x 40 cm  
**Área de Impresión:** 13 x 16 cm  
**Técnica de Impresión:** Bordado / Serigrafía  
**Colores:** A/N/R

Bolsa frontal y principal.

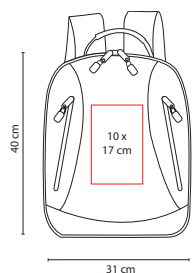

**Material:** Poliéster  
**Medida:** 31 x 40 cm  
**Área de Impresión:** 10 x 17 cm  
**Técnica de Impresión:** Bordado / Serigrafía  
**Colores:** A/O/P/R/V/Y



A



V



R



O



Y



P

## SIN 149

MOCHILA NEVERI

Bolsa frontal con doble cierre. Bolsa principal con organizador con 4 compartimentos.



O

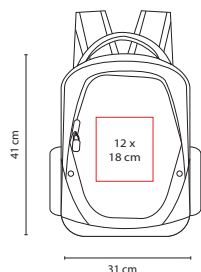

**Material:** Poliéster  
**Medida:** 31 x 41 cm  
**Área de Impresión:** 12 x 18 cm  
**Técnica de Impresión:** Bordado / Serigrafía  
**Colores:** A/N/O/R/V



A



R



N



V

## SIN 490

MOCHILA CAURA

Bolsa frontal intermedia y principal. Dos bolsas laterales de red. No incluye ánfora.

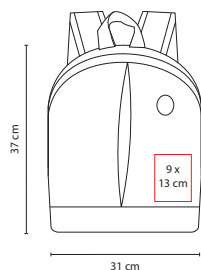
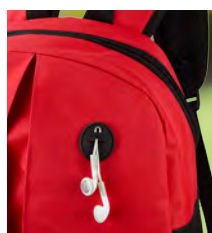

**Material:** Poliéster  
**Medida:** 31 x 37 cm  
**Área de Impresión:** 9 x 13 cm  
**Técnica de Impresión:** Bordado / Serigrafía  
**Colores:** A/O/R/V/Y



Y



V



O



A



R

## SIN 148

MOCHILA KEIT

Aditamento especial para audífonos. Bolsa principal con un compartimento interior.

SIN 120

MOCHILA MAURITANIA



R



A



N

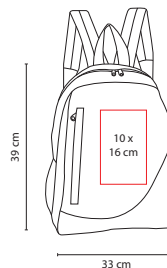

**Material:** Poliéster  
**Medida:** 33 x 39 cm  
**Área de Impresión:** 10 x 16 cm  
**Técnica de Impresión:** Bordado / Serigrafía  
**Colores:** A/N/R

Bolsa frontal y bolsa lateral de red.

SIN 010

MOCHILA VICTORY



S



O



N



A



R

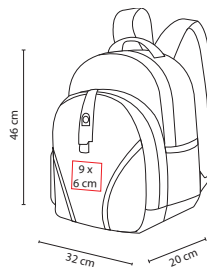

**Material:** Poliéster / Nylon  
**Medida:** 32 x 46 cm  
**Área de Impresión:** 9 x 6 cm  
**Técnica de Impresión:** Bordado / Serigrafía  
**Colores:** A/N/O/R/S

Compartimento lateral. Tirante y espalda acojinada. Aditamento especial para audífonos. No incluye cilindro.

SIN 025

MOCHILA OKY



A



R

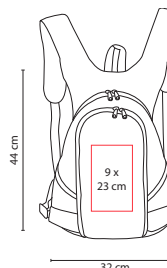

**Material:** Poliéster / Nylon  
**Medida:** 32 x 44 cm  
**Área de Impresión:** 9 x 23 cm  
**Técnica de Impresión:** Bordado / Serigrafía  
**Colores:** A/R

Bolsa frontal y dos bolsas laterales de red.

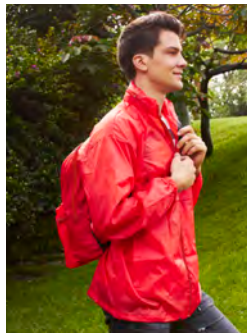

SIN 802

MOCHILA CHAMARRA



A



R



N

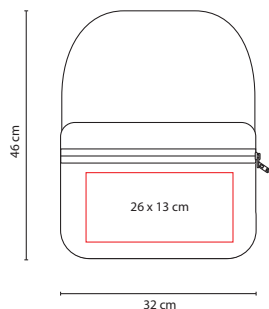

Material: Nylon  
Medida: M/L  
Área de Impresión: 26 x 13 cm Mochila  
Técnica de Impresión: Serigrafía  
Colores: A/N/R

Chamarras rompe vientos con gorro. Mochila con compartimento principal, bolsa frontal y bolsillo lateral.



SIN 903

MOCHILA ADVENTURE

tossh®

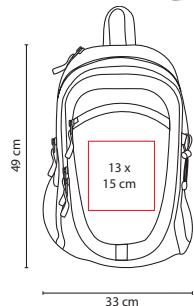

O



V



R



A

Material: Poliéster  
Medida: 33 x 49 cm  
Área de Impresión: 13 x 15 cm  
Técnica de Impresión: Bordado / Serigrafía  
Colores: A/O/R/V

Espacio para laptop. Tres bolsas frontales con compartimentos para celular y documentos. Bolsa lateral de malla. Respaldo y tirantes acojinados.



SIN 159

MOCHILA CAMBRIDGE



A



R



N

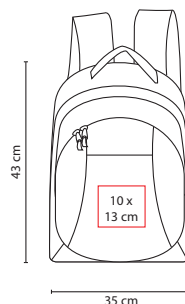

**Material:** Poliéster  
**Medida:** 35 x 43 cm  
**Área de Impresión:** 10 x 13 cm  
**Técnica de Impresión:** Bordado / Serigrafía  
**Colores:** A/N/R

Bolsa frontal con compartimento para 3 bolígrafos, celular y documentos. Espacio para laptop.

SIN 084

MOCHILA YANGZY

tossh®



A



N

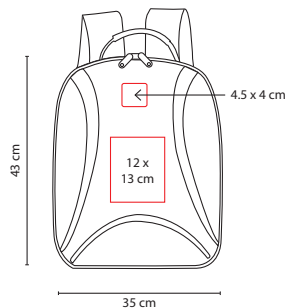

**Material:** Poliéster / Poliuretano  
**Medida:** 35 x 43 cm  
**Área de Impresión:** 4.5 x 4 cm Placa  
**Técnica de Impresión:** Goteado en Resina / Serigrafía  
**Colores:** Negro

Espacio para laptop y 3 compartimentos.





SIN 051

MOCHILA VADUZ

to<sup>ss</sup>h®

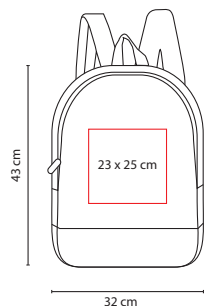

A



R

**Material:** Curpiel / Poliéster

**Medida:** 32 x 43 cm

**Área de Impresión:** 23 x 25 cm

**Técnica de Impresión:** Bordado / Serigrafía

**Colores:** A/R

Espacio para laptop.



SIN 375

MOCHILA RANSELL

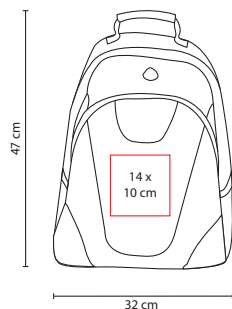

R

V



A

N



O

**Material:** Poliéster

**Medida:** 32 x 47 cm

**Área de Impresión:** 14 x 10 cm

**Técnica de Impresión:** Bordado / Serigrafía

**Colores:** A/N/O/R/V

Espacio para laptop. Bolsa principal y frontal con compartimentos para celular y bolígrafos. Bolsas laterales de malla. Aditamento especial para audífonos.

SIN 172

MOCHILA EJECUTIVA  
BARAHONA

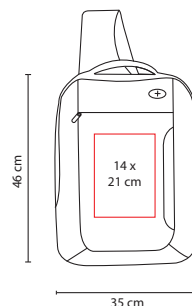

**Material:** Poliéster  
**Medida:** 35 x 46 cm  
**Área de Impresión:** 14 x 21 cm  
**Técnica de Impresión:** Bordado / Serigrafía  
**Colores:** Negro con Plata

Espacio para laptop. Incluye aditamento especial para audífonos, organizador de tarjetas y bolígrafos.

SIN 160

MOCHILA SALSBURGO



V



O



S



A



R

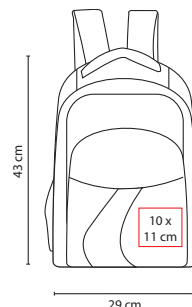

**Material:** Poliéster  
**Medida:** 29 x 43 cm  
**Área de Impresión:** 10 x 11 cm  
**Técnica de Impresión:** Bordado / Serigrafía  
**Colores:** A/O/R/S/V

Bolsa frontal con compartimento para 2 bolígrafos, celular y documentos. Espacio para laptop.



SIN 410

MOCHILA SURY

tossh®

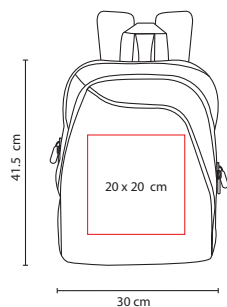

**Material:** Poliéster  
**Medida:** 30 x 41,5 cm  
**Área de Impresión:** 20 x 20 cm  
**Técnica de Impresión:** Bordado / Serigrafía  
**Colores:** A/N/O/R/V

Espacio para laptop. Bolsa principal y frontal con compartimentos para celular, bolígrafos, tarjetas y documentos. Respaldo y tirantes acolchados.



SIN 480

MOCHILA PROCIÓN

tossh®

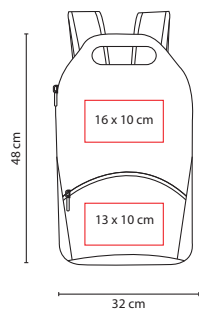

**Material:** Poliéster  
**Medida:** 32 x 48 cm  
**Área de Impresión:** 16 x 10 cm  
**Técnica de Impresión:** Bordado / Serigrafía  
**Colores:** A/R/S

Incluye espacio para laptop y con compartimento interno. Bolsa intermedia con organizador y 4 compartimentos. Bolsa frontal.

SIN 470

MOCHILA CELTA

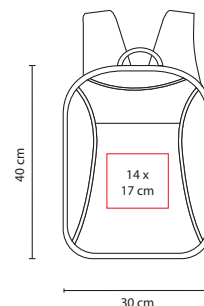
toss<sup>h</sup>

**Material:** Poliéster  
**Medida:** 30 x 40 cm  
**Área de Impresión:** 14 x 17 cm  
**Técnica de Impresión:** Bordado / Serigrafía  
**Colores:** Gris Oxford

Mini bolsa frontal, interior con organizador de 4 compartimentos, espacio para laptop. Tirantes y espalda acolijnada.

SIN 170

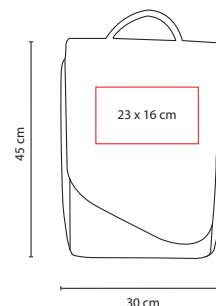
MOCHILA EJECUTIVA  
ZANSKAR

**Material:** Poliéster  
**Medida:** 30 x 45 cm  
**Área de Impresión:** 23 x 16 cm  
**Técnica de Impresión:** Bordado / Serigrafía  
**Colores:** Negro

Espacio para laptop.



SIN 070

MOCHILA MONTANA

tossh®

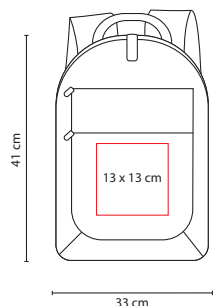

**Material:** Microfibra  
**Medida:** 33 x 41 cm  
**Área de Impresión:** 13 x 13 cm  
**Técnica de Impresión:** Bordado / Serigrafía  
**Colores:** Café

Incluye espacio frontal para laptop y con compartimento interno. Bolsa intermedia con organizador. Incluye 4 compartimentos.



SIN 902

MOCHILA METROPOLITAN

tossh®

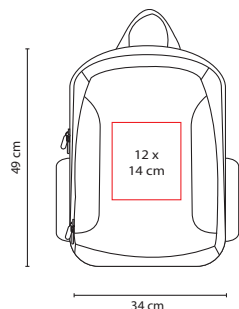

**Material:** Poliéster  
**Medida:** 34 x 49 cm  
**Área de Impresión:** 12 x 14 cm  
**Técnica de Impresión:** Bordado / Serigrafía  
**Colores:** Negro

Funda impermeable

Bolsa principal con espacio para laptop. Bolsa central para tablet. Bolsa frontal con compartimentos para celular, bolígrafos y documentos. Bolsas laterales con cierre. Respaldo y tirantes acolchados. Compartimento inferior con funda impermeable para la mochila. Incluye porta llaves.



SIN 142  
MOCHILA PORTA  
LAPTOP CORVUS  
**tossh**<sup>®</sup>

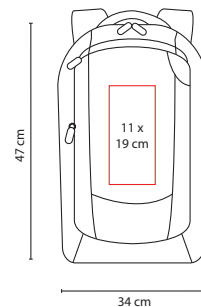

**Material:** Poliéster  
**Medida:** 34 x 47 cm  
**Área de Impresión:** 11 x 19 cm  
**Técnica de Impresión:** Bordado / Serigrafía  
**Colores:** Plata

Bolsa frontal con organizador con 6 compartimentos, bolsa principal con espacio para laptop, bolígrafos y documentos.

SIN 143  
MOCHILA TROLLEY  
POLUX  
**tossh**<sup>®</sup>

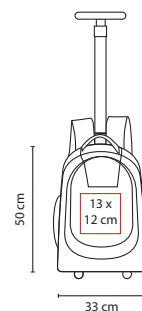
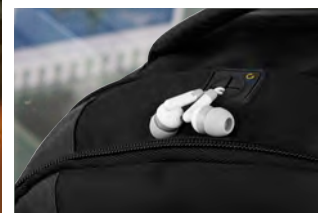

**Material:** Poliéster  
**Medida:** 33 x 50 cm  
**Área de Impresión:** 13 x 12 cm  
**Técnica de Impresión:** Bordado / Serigrafía  
**Colores:** Negro

Bolsa frontal con compartimento, aditamento especial para audífonos, compartimento para resguardo de tirantes, con dos bolsas laterales de red. Espacio para laptop.

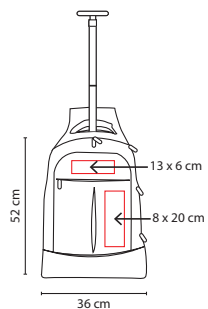
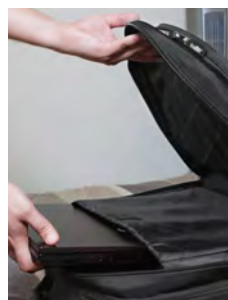
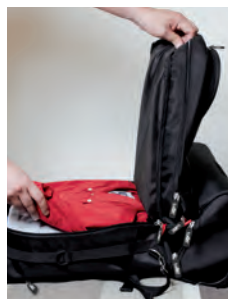

**Material:** Poliéster  
**Medida:** 36 x 52 cm  
**Área de Impresión:** 13 x 6 cm  
**Técnica de Impresión:** Bordado / Serigrafía  
**Colores:** Negro

Dos bolsas frontales con organizador, 7 compartimentos, espacio para laptop, compartimento para resguardo de tirantes y un compartimento inferior para zapatos.

## SIN 145

MOCHILA TROLLEY  
SIRIO

tossh®



## SIN 173

MOCHILA TROLLEY  
VALKHOF

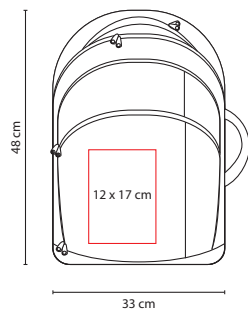

**Material:** Poliéster  
**Medida:** 33 x 48 cm  
**Área de Impresión:** 12 x 17 cm  
**Técnica de Impresión:** Bordado / Serigrafía  
**Colores:** Negro con Plata

Bolsa frontal y principal con espacio para laptop. Espalda acojinada.



SIN 039

PORTAFOLIO SOLUTIONS

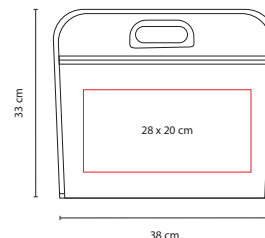

**Material:** Poliéster  
**Medida:** 38 x 33 cm  
**Área de Impresión:** 28 x 20 cm  
**Técnica de Impresión:** Serigrafía  
**Colores:** Negro

Espacio para documentos. Cierre frontal.

SIN 040

PORTAFOLIO BELEG

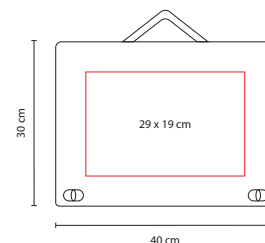

**Material:** Poliéster  
**Medida:** 40 x 30 cm  
**Área de Impresión:** 29 x 19 cm  
**Técnica de Impresión:** Bordado / Serigrafía  
**Colores:** Negro

Incluye organizador con 6 compartimentos.

SIN 095

PORTAFOLIO MILENIUM

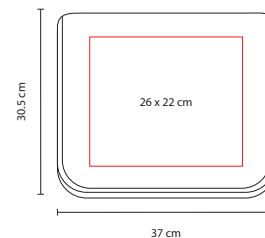

**Material:** Non Woven  
**Medida:** 37 x 30.5 cm  
**Área de Impresión:** 26 x 22 cm  
**Técnica de Impresión:** Serigrafía  
**Colores:** Negro con Gris

Espacio para tarjetas, bolígrafos y documentos.





PORTA LAPTOP

## SIN 110

PORTA LAPTOP  
CANBER



**Material:** Poliéster  
**Medida:** 36 x 32 cm  
**Área de Impresión:** 18 x 16 cm  
**Técnica de Impresión:** Bordado / Serigrafía  
**Colores:** Gris con Naranja

Incluye bolsa frontal. Bolsa principal para laptop de 13". Compartimento de silicona para audífonos.

## SIN 005

PORTAFOLIO  
STUDENT SUITCASE

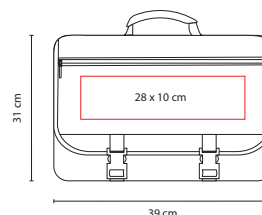

**Material:** Poliéster  
**Medida:** 39 x 31 cm  
**Área de Impresión:** 28 x 10 cm  
**Técnica de Impresión:** Bordado / Serigrafía  
**Colores:** Negro

Espacio para laptop, tarjetas y documentos. Bolsa frontal.

## SIN 135

PORTA LAPTOP CADIZ



R



A



N



O

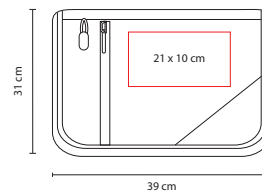

**Material:** Poliéster  
**Medida:** 39 x 31 cm  
**Área de Impresión:** 21 x 10 cm  
**Técnica de Impresión:** Bordado / Serigrafía  
**Colores:** A/N/O/R

Cuatro compartimentos, dos bolsas laterales de red con broche velcro.

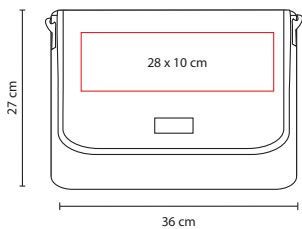

**Material:** Neopreno  
**Medida:** 36 x 27 cm  
**Área de Impresión:** 28 x 10 cm  
**Técnica de Impresión:** Serigrafía  
**Colores:** A/N/O/P/R/V

Porta Laptop de 16" con correa. Broche velcro.

## LAP 005

PORTA LAPTOP  
LOANDA



V

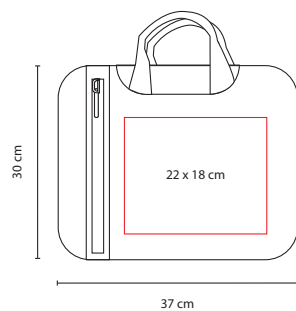

**Material:** Poliéster  
**Medida:** 37 x 30 cm  
**Área de Impresión:** 22 x 18 cm  
**Técnica de Impresión:** Bordado / Serigrafía  
**Colores:** A/N/O/R

Tres compartimentos.

## SIN 136

PORTA LAPTOP  
DANUVIO



O

SIN 001

PORTAFOLIO  
EJECUTIVO

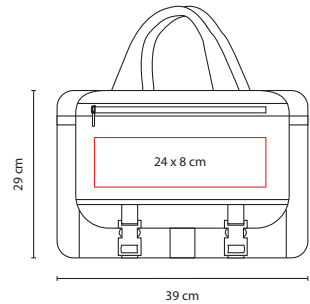

**Material:** Curpiel  
**Medida:** 39 x 29 cm  
**Área de Impresión:** 24 x 8 cm  
**Técnica de Impresión:** Bordado / Serigrafía  
**Colores:** Negro

Espacio para laptop, tarjetas y documentos. Bolsa frontal.

SIN 720

PORTAFOLIO VIAJE  
MELBOURNE

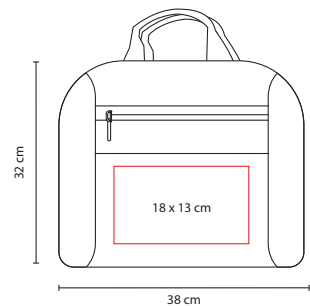

**Material:** Poliéster  
**Medida:** 38 x 32 cm  
**Área de Impresión:** 18 x 13 cm  
**Técnica de Impresión:** Bordado  
**Colores:** Negro con Plata

Espacio para laptop y bolsa frontal.



SIN 058

PORTA LAPTOP  
POLAR

tossh®

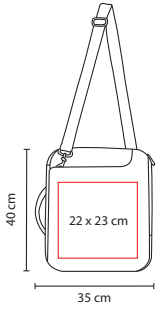

**Material:** Feltro  
**Medida:** 35 x 40 cm  
**Área de Impresión:** 22 x 23 cm  
**Técnica de Impresión:** Bordado  
**Colores:** Gris

Bolsa frontal con compartimento para bolígrafos y celular. Incluye bolsa principal para laptop hasta 17" y una bolsa trasera.



SIN 180

PORTAFOLIO BAMAKO

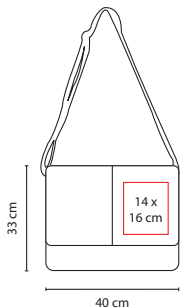

**Material:** Curpiel / Forro de Gamuza  
**Medida:** 40 x 33 cm  
**Área de Impresión:** 14 x 16 cm  
**Técnica de Impresión:** Termograbado  
**Colores:** Chocolate / Negro

Espacio para laptop, tarjetas y documentos. Doble cierre posterior para colocar en trolley.

SIN 191

BOLSA EJECUTIVA  
MORAVIA

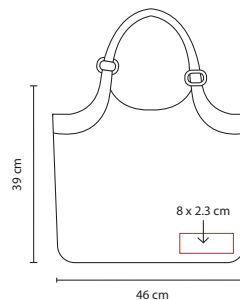

**Material:** Curpiel  
**Medida:** 46 x 39 cm  
**Área de Impresión:** 8 x 2.3 cm Placa  
**Técnica de Impresión:** Láser  
**Colores:** Blanco con Negro

Espacio para laptop, tarjetas y documentos.

SIN 190

PORTAFOLIO PRAGA



R



C

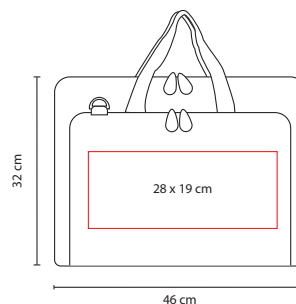

**Material:** Curpiel  
**Medida:** 46 x 32 cm  
**Área de Impresión:** 28 x 19 cm  
**Técnica de Impresión:** Termograbado  
**Colores:** Chocolate / Rojo

Espacio para laptop, tarjetas y documentos.



SIN 308

PORTA LAPTOP  
FLORENCIA

tossh®

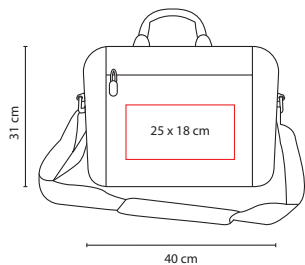

**Material:** Microfibra  
**Medida:** 40 x 31 cm  
**Área de Impresión:** 25 x 18 cm  
**Técnica de Impresión:** Bordado / Serigrafía  
**Colores:** Café

Bolsa frontal con compartimentos para bolígrafos, celular y tarjetas. Bolsa principal con 3 compartimentos para accesorios y un espacio acojinado para laptop de 15". Con asa metálica.

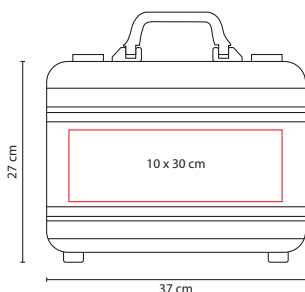

SIN 045

PORTAFOLIO  
AMBERES



**Material:** Aluminio  
**Medida:** 37 x 27 cm  
**Área de Impresión:** 10 x 30 cm  
**Técnica de Impresión:** Pantógrafo  
**Colores:** Plata

Espacio para notebook de 12". Compartimentos interiores para bolígrafos y documentos. Incluye correa.

SIN 132

MALETA LYRA



R



O



N



A



V

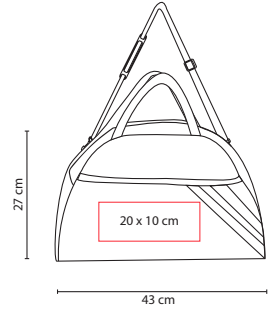

**Material:** Nylon / Malla  
**Medida:** 43 x 27 cm  
**Área de Impresión:** 20 x 10 cm  
**Técnica de Impresión:** Serigrafía  
**Colores:** A/N/O/R/V

Bolsa principal y frontal.

SIN 151

MALETA CAIRO



A



V



R



Y



O

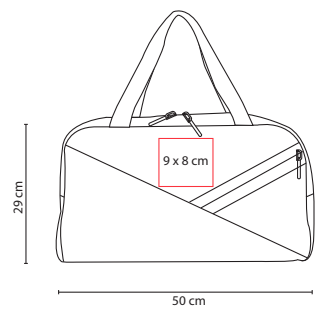

**Material:** Poliéster  
**Medida:** 50 x 29 cm  
**Área de Impresión:** 9 x 8 cm  
**Técnica de Impresión:** Bordado / Serigrafía  
**Colores:** A/O/R/V/Y

Bolsa principal y frontal de red.





SIN 503

MALETA MORGAN



S



O



A



R

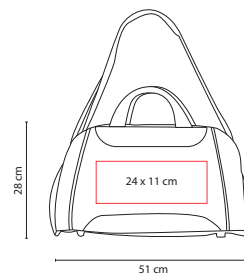

**Materia:** Poliéster / Malla  
**Medida:** 51 x 28 cm  
**Área de Impresión:** 24 x 11 cm  
**Técnica de Impresión:** Bordado / Serigrafía  
**Colores:** A/O/R/S

Bolsa principal, frontal para zapatos y compartimento lateral. No incluye cilindro.

SIN 032

MALETA SPORT



A



O



V



R

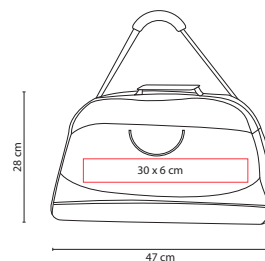

**Materia:** Poliéster / Nylon  
**Medida:** 47 x 28 cm  
**Área de Impresión:** 30 x 6 cm  
**Técnica de Impresión:** Bordado / Serigrafía  
**Colores:** A/O/R/V

Bolsa frontal.

SIN 280

MALETA DRACO



O



G



A



R

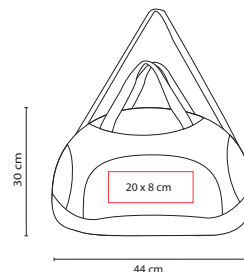

**Materia:** Poliéster  
**Medida:** 44 x 30 cm  
**Área de Impresión:** 20 x 8 cm  
**Técnica de Impresión:** Bordado / Serigrafía  
**Colores:** A/G/O/R

Bolsa principal y frontal.



## SIN 139

MALETA ODIEL



S



A



O



R



Y



V

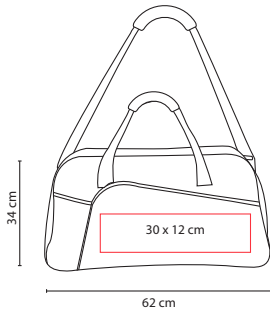

**Material:** Poliéster  
**Medida:** 62 x 34 cm  
**Área de Impresión:** 30 x 12 cm  
**Técnica de Impresión:** Bordado / Serigrafía  
**Colores:** A/O/R/S/V/Y

Bolsa principal y frontal. Dos compartimentos.

## SIN 133

MALETA MING



A



V



Y



O



R

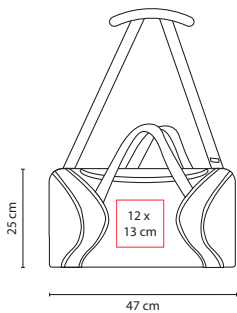

**Material:** Poliéster  
**Medida:** 47 x 25 cm  
**Área de Impresión:** 12 x 13 cm  
**Técnica de Impresión:** Bordado / Serigrafía  
**Colores:** A/O/R/V/Y

Bolsa de red lateral.

SIN 333

MALETA PACIFIC ISLAND



A



O



R



V

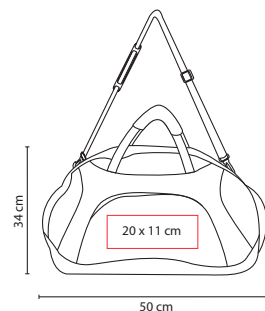

**Material:** Nylon / Malla  
**Medida:** 50 x 34 cm  
**Área de Impresión:** 20 x 11 cm  
**Técnica de Impresión:** Bordado / Serigrafía  
**Colores:** A/O/R/V

Bolsa principal, frontal y 2 compartimentos laterales.

SIN 305

MALETA PIONEER



A



S



R

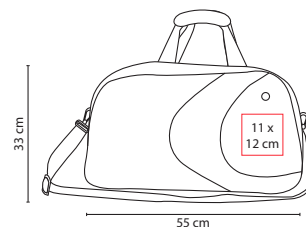
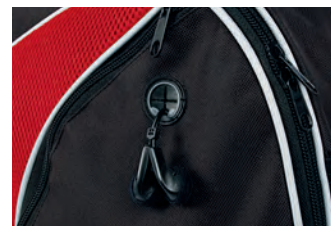

**Material:** Poliéster / Malla  
**Medida:** 55 x 33 cm  
**Área de Impresión:** 11 x 12 cm  
**Técnica de Impresión:** Bordado / Serigrafía  
**Colores:** A/R/S

Bolsa principal y compartimento lateral. Aditamento especial para audífonos.



R

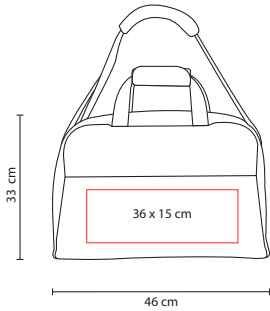

A

**Material:** Poliéster  
**Medida:** 46 x 33 cm  
**Área de Impresión:** 36 x 15 cm  
**Técnica de Impresión:** Bordado / Serigrafía  
**Colores:** A/G/R

Bolsa principal con 2 compartimentos de malla y bolsillo para celular. Bolsa frontal con cierre. Agarradera posterior con broche velcro para colocar en trolley.

SIN 052

MALETA MEIRA

tossh®



G

SIN 460

MALETA EGEO



A

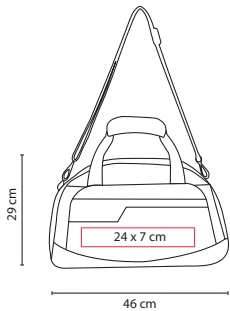

G

**Material:** Poliéster  
**Medida:** 46 x 29 cm  
**Área de Impresión:** 24 x 7 cm  
**Técnica de Impresión:** Bordado / Serigrafía  
**Colores:** A/G/R

Bolsa principal con compartimento interno y bolsa frontal.



R

## SIN 300

MALETA BLOMSBURY

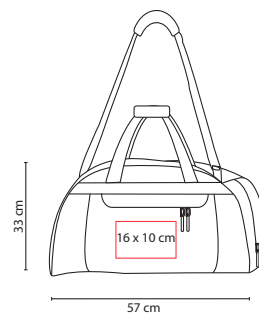

**Material:** Poliéster  
**Medida:** 57 x 33 cm  
**Área de Impresión:** 16 x 10 cm  
**Técnica de Impresión:** Bordado / Serigrafía  
**Colores:** Negro con Plata

Bolsa principal, frontal y lateral.

## SIN 028

MALETA TRAVEL

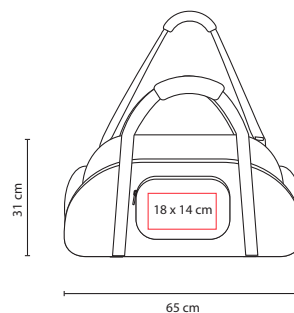

**Material:** Poliéster / Nylon  
**Medida:** 65 x 31 cm  
**Área de Impresión:** 18 x 14 cm  
**Técnica de Impresión:** Bordado / Serigrafía  
**Colores:** A/O/R/V/Y

Bolsa principal, frontal y 2 laterales.



SIN 056

MALETA NARA

tossh®



R



O



V



N



A



**Material:** Plástico PVC  
**Medida:** 47 x 31 cm  
**Área de Impresión:** 35 x 15 cm  
**Técnica de Impresión:** Serigrafía  
**Colores:** A/N/O/R/V

Bolsa principal y frontal.

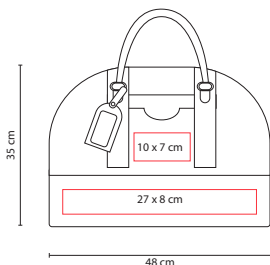

**Material:** Poliéster  
**Medida:** 48 x 35 cm  
**Área de Impresión:** 27 x 8 cm  
**Técnica de Impresión:** Bordado / Serigrafía  
**Colores:** Negro

Bolsa principal y espacio para zapatos. Incluye identificador de maletas.

SIN 150

MALETA CADDY



MALETAS



SIN 184

BOLSA COLOMBO

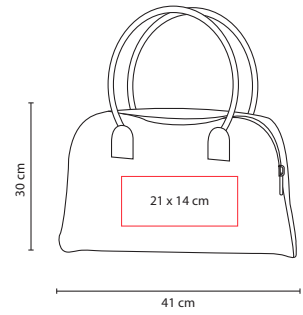

**Material:** Poliéster  
**Medida:** 41 x 30 cm  
**Área de Impresión:** 21 x 14 cm  
**Técnica de Impresión:** Bordado / Serigrafía  
**Colores:** Blanco con Gris

SIN 306

BOLSA MALETA  
MARRAKECH

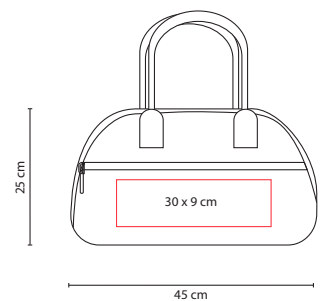

**Material:** 100% Algodón  
**Medida:** 45 x 25 cm  
**Área de Impresión:** 30 x 9 cm  
**Técnica de Impresión:** Bordado / Serigrafía  
**Colores:** A/C/O/P/R/V

Bolsa principal y frontal.





SIN 053

MALETA CHESTER

tossh®



R



G



A



P



**Material:** Curpiel  
**Medida:** 56 x 36 cm  
**Área de Impresión:** 38 x 18 cm  
**Técnica de Impresión:** Serigrafía  
**Colores:** A/G/P/R

Bolsa principal y frontal de red.

SIN 710

MALETA SIERRA NEVADA

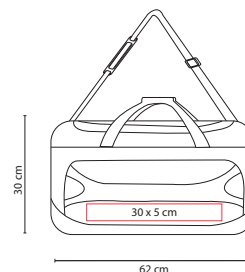

**Material:** Poliéster / Nylon  
**Medida:** 62 x 30 cm  
**Área de Impresión:** 30 x 5 cm  
**Técnica de Impresión:** Bordado / Serigrafía  
**Colores:** Negro con Plata

Maleta trolley con bolsa principal y frontal.

SIN 035

MALETA LAOS

tossh®



A



R

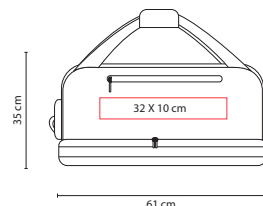

**Material:** Poliéster  
**Medida:** 61 x 35 cm  
**Área de Impresión:** 32 x 10 cm  
**Técnica de Impresión:** Bordado / Serigrafía  
**Colores:** A/R/S

Maleta trolley con bolsa principal, compartimento frontal y posterior, dos bolsas laterales y una interior.

SIN 140

MALETA LUXOR

tossh®

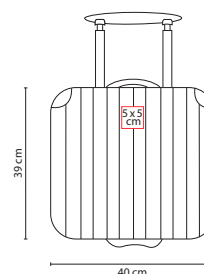

**Material:** Plástico / Nylon  
**Medida:** 40 x 39 cm  
**Área de Impresión:** 5 x 5 cm  
**Técnica de Impresión:** Láser en placa metálica  
**Colores:** Gris

Cuatro compartimentos interiores. Incluye funda para laptop.



SIN 307

MALETA ANDINO

tossh®



**Material:** Microfibra  
**Medida:** 50 x 33 cm  
**Área de Impresión:** 27 x 16 cm  
**Técnica de Impresión:** Bordado / Serigrafía  
**Colores:** Café

Bolsa principal, bolsa frontal con compartimento para celular, bolígrafos y documentos.



Placa removible.

SIN 154

MALETA TROLLEY  
 IVAR

tossh®

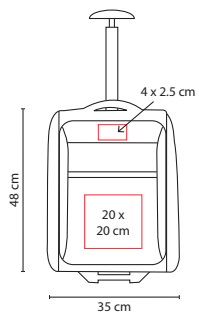





**Material:** Poliéster  
**Medida:** 35 x 48 cm  
**Área de Impresión:** 20 x 20 cm  
**Técnica de Impresión:** Bordado / Grabado en Placa Metálica  
**Colores:** Negro

Bolsa frontal y principal. Placa por separado para fácil grabado.

PLY 006

PLAYERA FARELL

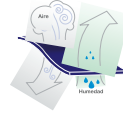

<p>Alta Tecnología 4 en 1</p> <p>  PERMEABLE PROTECCIÓN UV</p> <p>  ANTIBACTERIAL ANTIESTÁTICA</p>	<ul style="list-style-type: none"> <li>Tela COOL COMFORT, repele la humedad manteniéndola fresca, seca, suave y cómoda.</li> <li>Perdurable lavada tras lavada.</li> </ul>	 <p>Tecnología KEEP DRY: te mantiene fresco y cómodo.</p>
--	--	--



D



N



S

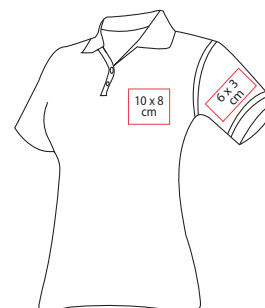
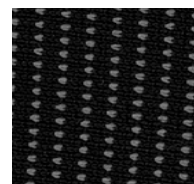

**Material:** 52% Poliéster / 48% Bamboo  
**Tallas:** CH/M/G/XL  
**Área de Impresión:** 10 x 8 cm  
**Técnica de Impresión:** Bordado / Serigrafía  
**Colores:** D/N/S  
**Tipo:** Polo

Playera para dama. Diseño de puntos, con protección UV UPF 25.

PLY 005

PLAYERA RAVEL



 <p>Tecnología KEEP DRY: te mantiene fresco y cómodo.</p>	<ul style="list-style-type: none"> <li>Tela COOL COMFORT, repele la humedad manteniéndola fresca, seca, suave y cómoda.</li> <li>Perdurable lavada tras lavada.</li> <li>Fibra fabricada a partir de poliéster reciclado, ayudando a la conservación de los recursos naturales.</li> </ul>
--	--



V



A



B



N

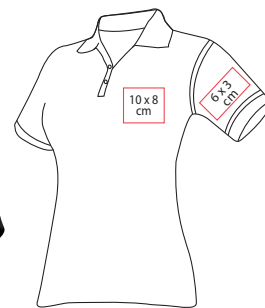
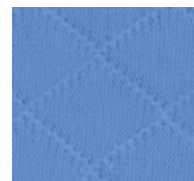

**Material:** 100% Poliéster Ecológico  
**Tallas:** CH/M/G/XL  
**Área de Impresión:** 10 x 8 cm  
**Técnica de Impresión:** Bordado / Serigrafía  
**Colores:** A/B/N/V  
**Tipo:** Polo

Playera para dama. Diseño de rombos pequeños.



PLAYERAS

PLY 003  
PLAYERA SORRELL



<p>Alta Tecnología 4 en 1</p> <p>PERMEABLE PROTECCIÓN UV ANTIBACTERIAL ANTIESTÁTICA</p>	<ul style="list-style-type: none"> <li>Tela COOL COMFORT, repele la humedad manteniéndola fresca, seca, suave y cómoda.</li> <li>Perdurable lavada tras lavada.</li> </ul>	 <p>Tecnología KEEP DRY: te mantiene fresco y cómodo.</p>
---	--	--



B



A

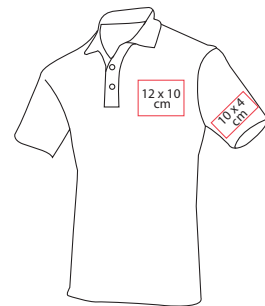
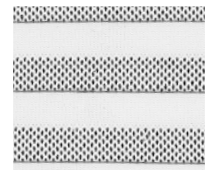

**Material:** 71% Poliéster / 29% Bamboo  
**Tallas:** CH/M/G/XL  
**Área de Impresión:** 12 x 10 cm  
**Técnica de Impresión:** Bordado / Serigrafía  
**Colores:** A/B  
**Tipo:** Polo

Diseño de rayas horizontales con protección UV UPF 25.

PLY 002  
PLAYERA YAGER

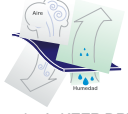

 <p>Tecnología KEEP DRY: te mantiene fresco y cómodo.</p>	<ul style="list-style-type: none"> <li>Tela COOL COMFORT, repele la humedad manteniéndola fresca, seca, suave y cómoda.</li> <li>Perdurable lavada tras lavada.</li> <li>Fibra fabricada a partir de poliéster reciclado, ayudando a la conservación de los recursos naturales.</li> </ul>
--	--



A



B



V



N

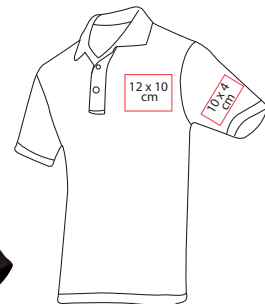
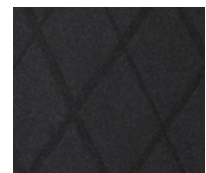

**Material:** 100% Poliéster Ecológico  
**Tallas:** CH/M/G/XL  
**Área de Impresión:** 12 x 10 cm  
**Técnica de Impresión:** Bordado / Serigrafía  
**Colores:** A/B/N/V  
**Tipo:** Polo

Diseño de rombos.



Tecnología KEEP DRY:  
te mantiene fresco y cómodo.

- Tela COOL COMFORT, repele la humedad manteniéndola fresca, seca, suave y cómoda.
- Perdurable lavada tras lavada.
- Fibra fabricada a partir de poliéster reciclado, ayudando a la conservación de los recursos naturales.

PLY 001

PLAYERA FOSTER

prakticasport®

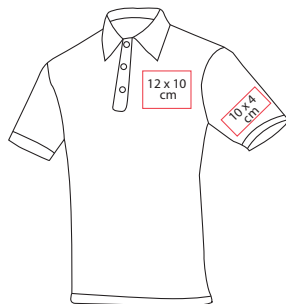
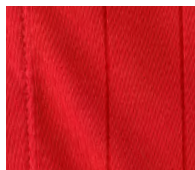

N



B



R

**Material:** 100% Poliéster Ecológico

**Tallas:** CH/M/G/XL

**Área de Impresión:** 12 x 10 cm

**Técnica de Impresión:** Bordado / Serigrafía

**Colores:** B/N/R

**Tipo:** Polo

Diseño a rayas verticales.

Alta Tecnología  
4 en 1



PERMEABLE



PROTECCIÓN UV  
(UPF 25+)



ANTIBACTERIAL



ANTIESTÁTICA

- Tela COOL COMFORT, repele la humedad manteniéndola fresca, seca, suave y cómoda.
- Perdurable lavada tras lavada.

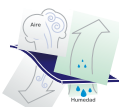

Tecnología KEEP DRY:  
te mantiene fresco y cómodo.

PLY 004

PLAYERA CLASBENT

prakticasport®

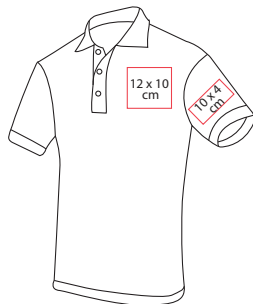
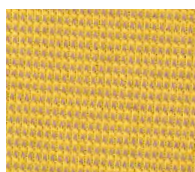

D



S



N

**Material:** 52% Poliéster / 48% Bamboo

**Tallas:** CH/M/G/XL

**Área de Impresión:** 12 x 10 cm

**Técnica de Impresión:** Bordado / Serigrafía

**Colores:** D/N/S

**Tipo:** Polo

Diseño de puntos, con protección UV UPF 25.

CAP 006

VISERA SUMMER



R



B



A



N

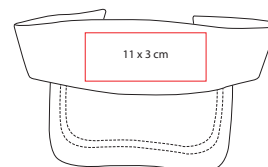

**Material:** Poliéster  
**Circunferencia Interna:** 57 cm  
**Área de Impresión:** 11 x 3 cm  
**Técnica de Impresión:** Bordado / Serigrafía  
**Colores:** A/B/N/R  
**Talla:** Unitalla

Broche de velcro.

CAP 005

GORRA RAINBOW



A



O



V



Y



B

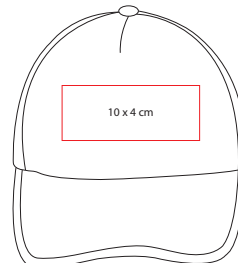

N



R

**Material:** Poliéster  
**Circunferencia Interna:** 59 cm  
**Área de Impresión:** 10 x 4 cm  
**Técnica de Impresión:** Bordado / Serigrafía  
**Colores:** A/B/N/O/R/V/Y  
**Talla:** Unitalla

Broche de velcro.

COOL 001

GORRA COOL



O



Y



B



R



A

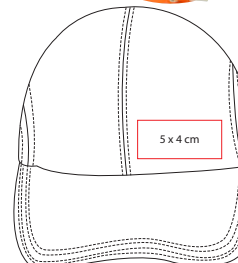

V



N

**Material:** Poliéster  
**Circunferencia Interna:** 59 cm  
**Área de Impresión:** 5 x 4 cm  
**Técnica de Impresión:** Bordado  
**Colores:** A/B/N/O/R/V/Y  
**Talla:** Unitalla

Broche metálico.





ARMY 001

GORRA ARMY



C



V

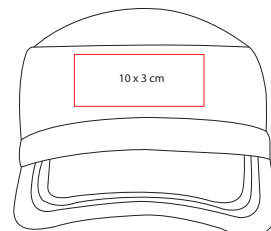

**Material:** Microfibra  
**Circunferencia Interna:** 59 cm  
**Área de Impresión:** 10 x 3 cm  
**Técnica de Impresión:** Bordado / Serigrafía  
**Colores:** C/V  
**Talla:** Unitalla

Broche metálico.

GEP 003

GORRA DE ALGODÓN



AM

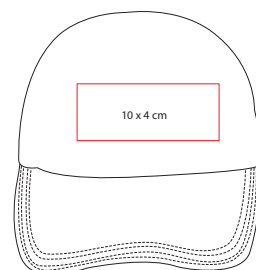

**Material:** Algodón  
**Circunferencia Interna:** 57 cm  
**Área de Impresión:** 10 x 4 cm  
**Técnica de Impresión:** Bordado / Serigrafía  
**Colores:** A/AM/B/K/N/R/V/Y  
**Talla:** Unitalla

Broche de velcro.

GSP 002

GORRA SÁNDWICH



V

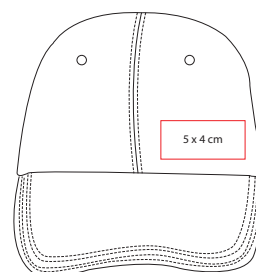

**Material:** Algodón  
**Circunferencia Interna:** 57 cm  
**Área de Impresión:** 5 x 4 cm  
**Técnica de Impresión:** Bordado / Serigrafía  
**Colores:** A/AR/G/K/N/R/V/W/Y  
**Talla:** Unitalla

Broche velcro, sándwich del mismo color de la gorra.

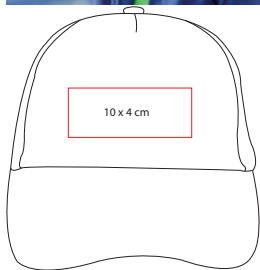
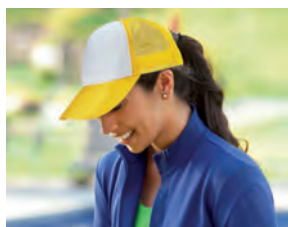

**Material:** Poliéster / Red de Polipropileno  
**Circunferencia Interna:** 59 cm  
**Área de Impresión:** 10 x 4 cm  
**Técnica de Impresión:** Bordado / Serigrafía  
**Colores:** A/B/N/O/R/V/Y  
**Talla:** Unitalla

Broche de plástico.

## CAP 004

GORRA TRUCKER

prakticasport.



A

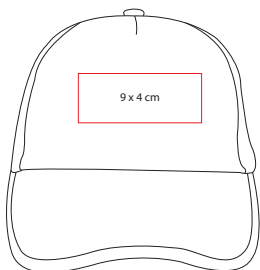

**Material:** Paja Sintética / Poliéster  
**Circunferencia Interna:** 59 cm  
**Área de Impresión:** 9 x 4 cm  
**Técnica de Impresión:** Bordado / Serigrafía  
**Colores:** A/B/N/O/R/V/Y  
**Talla:** Unitalla

Broche de velcro. Paja sintética.

## CAP 002

GORRA SYNTHETIC STRAW

prakticasport.



R

HAT 001

SOMBRERO RIDER

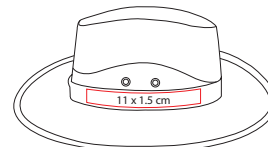

**Material:** Poliéster  
**Circunferencia Interna:** 59 cm  
**Área de Impresión:** 11 x 1,5 cm  
**Técnica de Impresión:** Bordado / Serigrafía  
**Colores:** Beige  
**Talla:** Unitalla

Cinta removible en color negro.

GMR 001

GORRA REFLECTIVE



R



O



A



N



B

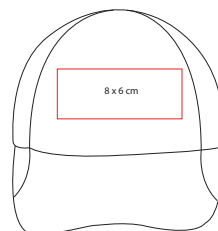

V



Y

**Material:** Microfibra / Malla  
**Circunferencia Interna:** 57 cm  
**Área de Impresión:** 8 x 6 cm  
**Técnica de Impresión:** Bordado  
**Colores:** A/B/N/O/R/V/Y  
**Talla:** Unitalla

Broche de plástico.

CAP 003

GORRA PORTA LENTES



V



Y



O



B



N

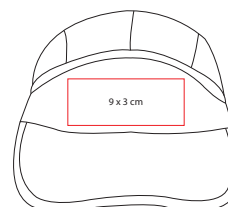

A



R

**Material:** Poliéster  
**Circunferencia Interna:** 59 cm  
**Área de Impresión:** 9 x 3 cm  
**Técnica de Impresión:** Bordado / Serigrafía  
**Colores:** A/B/N/O/R/V/Y  
**Talla:** Unitalla

Con porta lentes. Broche de velcro. No incluye lentes.



CHAMARRAS

### CHM 005

CHAMARRA BREAK WIND



V



A



AM



B



N



R



**Material:** Nylon  
**Talla:** Unitala  
**Área de Impresión:** 12 x 10 cm  
**Técnica de Impresión:** Bordado / Serigrafía  
**Colores:** A/AM/B/N/R/V

Rompe vientos 100% nylon. Sin resorte.

### CHM 003

CHAMARRA DEPORTIVA PLUS



AM



A



N



R



**Material:** Nylon  
**Talla:** M / L / XL  
**Área de Impresión:** 12 x 10 cm  
**Técnica de Impresión:** Bordado / Serigrafía  
**Colores:** A/AM/N/R

100% Nylon forro antiestático, repelente al agua con bolsas laterales.

### CHM 006

CHAMARRA JACKET CLASS



R-N



AM-R



G-N



AM-Y



B-AR



**Material:** Nylon  
**Talla:** M / L  
**Área de Impresión:** 12 x 10 cm  
**Técnica de Impresión:** Bordado / Serigrafía  
**Colores:** AM-R/AM-Y/B-AR/G-N/R-N

Chamarras en dos colores.

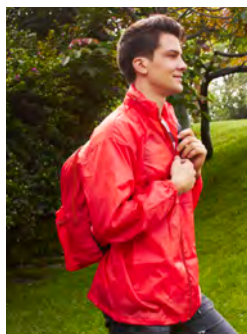

SIN 802

MOCHILA CHAMARRA



A



R



N

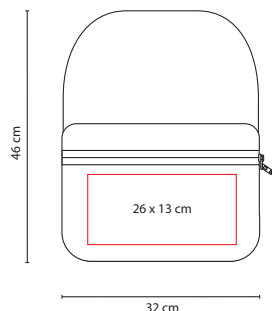

Material: Nylon

Talla: M / L

Área de Impresión: 26 x 13 cm Mochila

Técnica de Impresión: Serigrafía

Colores: A/N/R

Chamarras rompe vientos con gorro y mochila con compartimento principal, bolsa frontal y bolsillo lateral.

CHM 007

CHAMARRA  
MANCHESTER

prakticasport.



S

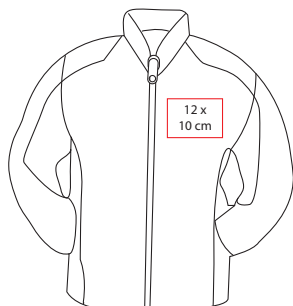

R



A

Material: Poliéster

Talla: M / L

Área de Impresión: 12 x 10 cm

Técnica de Impresión: Bordado / Serigrafía

Colores: A/R/S

Con bolsas laterales y gorro.

## PL 1500

BOLÍGRAFO  
POCKET-LIGHT

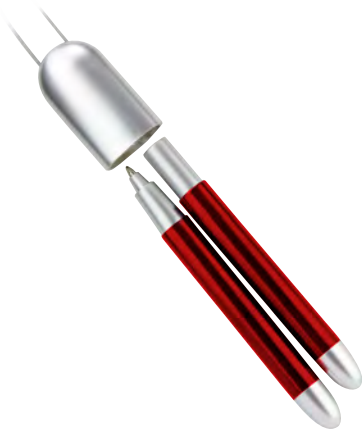

**Material:** Plástico  
**Medida:** 12 cm  
**Área de Impresión:** 1 x 5 cm  
Bolígrafo y Lámpara / 1.5 x 2 cm Base  
**Técnica de Impresión:** Serigrafía  
**Colores:** Rojo  
**Tinta:** Negra

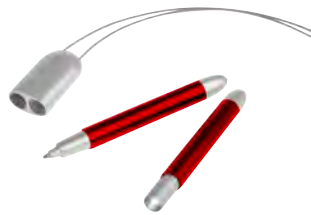

Incluye bolígrafo y lámpara con tapón imantado.

## LAM 400

LÁMPARA CON LEDES  
QUANTUM



**Material:** Metal  
**Medida:** 17 cm  
**Área de Impresión:** 1.5 x 7.5 cm  
**Técnica de Impresión:** Pantógrafo / Serigrafía  
**Colores:** Rojo



3 LEDES. Incluye cordón y baterías (AA).

## USB 003

MEMORIA USB  
EXTREME



**Material:** Plástico  
**Medida:** 3 x 8.2 cm  
**Área de Impresión:** 1.5 x 2 cm  
**Técnica de Impresión:** Serigrafía  
**Colores:** Rojo  
**Capacidad:** 2 GB



Memoria USB con brújula y cordón de 46cm. Incluye caja individual.

## PRO 220

REFLEJANTE LOTUS



A

**Material:** Plástico  
**Medida:** 6.5 x 13 cm  
**Área de Impresión:** 1.5 x 3 cm  
**Técnica de Impresión:** Serigrafía  
**Colores:** A/B/R



R

B

Incluye batería de botón.

## DPO 016

BOLÍGRAFO  
MULTIFUNCIONES  
CORBY



A

**Material:** Plástico  
**Medida:** 2 x 13 cm  
**Área de Impresión:** 0.5 x 4 cm  
**Técnica de Impresión:** Serigrafía  
**Colores:** A/N  
**Tinta:** Negra



N

Bolígrafo con lámpara, regla de 8 cm, láser y apuntador de agenda electrónica.

## HL 3500

LIBRETA EXPO CON  
CORDÓN



**Material:** Espiral Metálico / Plástico  
**Medida:** 7 x 9.5 cm  
**Área de Impresión:** 6 x 7 cm  
**Técnica de Impresión:** Serigrafía  
**Colores:** Dorado

60 Hojas de raya y cordón. No Incluye bolígrafo.





## PRO 200

PORTANOTAS  
FLAMINGO



V

**Material:** Plástico  
**Medida:** 13 x 17 cm  
**Área de Impresión:** 25.5 x 6.5 cm  
**Técnica de Impresión:** Serigrafía  
**Colores:** O/R/V

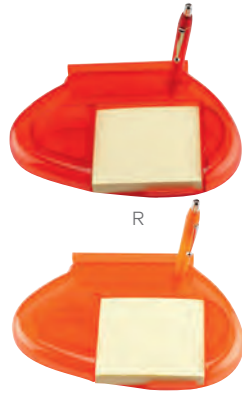

R

O

Incluye bolígrafo, 100 hojas de notas, tarjetero y porta clips.

## GSP 001

GORRA SÁNDWICH

**Material:** Algodón  
**Circunferencia interna:** 58 cm  
**Área de Impresión:** 5 x 4 cm  
**Técnica de Impresión:** Bordado / Serigrafía  
**Colores:** Azul Rey  
**Talla:** Unitalla



Broche de velcro.

## MK 070

RELOJ MERCURY



**Material:** Plástico  
**Medida:** 9 x 12 cm  
**Área de Impresión:** 2 x 7 cm  
**Técnica de Impresión:** Serigrafía  
**Colores:** Reloj Blanco / Líquido Azul



Funciones: Reloj, calendario y alarma.  
Flotantes: Cápsula, jeringa y pastilla.  
Incluye batería.

## PRO 070

PORTA PAPELES  
NAUTILUS

**Material:** Plástico  
**Medida:** 4 x 7 cm  
**Área de Impresión:** 2 x 4.5 cm  
**Técnica de Impresión:** Serigrafía  
**Colores:** Verde



Líquido verde, rana flotante.

## MK 001

RELOJ DE OFICINA  
OREGON



**Material:** Plástico  
**Medida:** 8.5 x 12.5 cm  
**Área de Impresión:** 2 x 7.5 cm  
**Técnica de Impresión:** Serigrafía  
**Colores:** Blanco



Funciones: Reloj, alarma, termómetro y fecha.  
Cambia de función al presionar.  
Imán para clips.  
Baterías (2 pilas AAA) no incluidas.

## MK 5272

CALCULADORA RETRO

**Material:** Plástico  
**Medida:** 8.2 x 12.5 cm  
**Área de Impresión:** 3 x 6 cm  
**Técnica de Impresión:** Serigrafía / Tampografía  
**Colores:** Plata con Negro



Calculadora solar de 8 dígitos con mecanismo deslizable automático para abrir la pantalla.

## SH 1170

### BOLÍGRAFO DUNY



A

**Material:** Plástico  
**Medida:** 14 cm  
**Área de Impresión:** 1.5 x 6.5 cm Cuerpo /  
1 x 5 cm Clip  
**Técnica de Impresión:** Serigrafía  
**Colores:** A/R  
**Tinta:** Negra



R

Mecanismo pulsador.

## SH 1800

### BOLÍGRAFO INFINITY

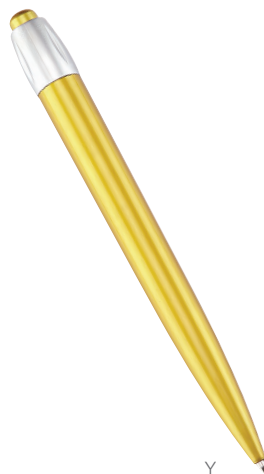

Y

**Material:** Plástico  
**Medida:** 14 cm  
**Área de Impresión:** 1 x 6 cm  
**Técnica de Impresión:** Serigrafía  
**Colores:** R/V/Y Metalizados  
**Tinta:** Negra



V



R

Mecanismo pulsador.

## SH 1320

### BOLÍGRAFO VELEZ



V

**Material:** Plástico  
**Medida:** 1 x 11 cm  
**Área de Impresión:** 1 x 4 cm  
**Técnica de Impresión:** Serigrafía  
**Colores:** A/N/O/R/V  
**Tinta:** Negra



O

N

A

R

Mecanismo pulsador.

## SH 2500

### BOLÍGRAFO MONTREAL

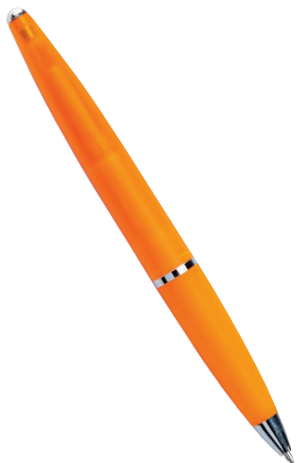

Mecanismo Twist.

**Material:** Plástico  
**Medida:** 13.5 cm  
**Área de Impresión:** 1 x 5 cm  
**Técnica de Impresión:** Serigrafía  
**Colores:** Naranja  
**Tinta:** Negra

## SG 204

### BOLÍGRAFO 4 EN 1



**Material:** Metal  
**Medida:** 14.5 cm  
**Área de Impresión:** 1.5 x 2 cm  
**Técnica de Impresión:** Pantógrafo /  
Serigrafía  
**Colores:** Plata  
**Tinta:** Negra / Roja



Lapicera

Apuntador

Bolígrafo con tinta negra y roja,  
apuntador de agenda electrónica  
y lapicera.

## SH 1490

BOLÍGRAFO DECO



**Material:** Plástico  
**Medida:** 14,5 cm  
**Área de Impresión:** 1 x 10 cm  
**Técnica de Impresión:** Serigrafía  
**Colores:** A/B/N  
**Tinta:** Negra



Bolígrafo con tapón.

## SH 1580 Y

BOLÍGRAFO RING



**Material:** Plástico  
**Medida:** 1 x 14 cm  
**Área de Impresión:** 1 x 4 cm  
**Técnica de Impresión:** Serigrafía  
**Colores:** Amarillo  
**Tinta:** Negra

Mecanismo Pulsador

## SH 1050

BOLÍGRAFO KANGRI



**Material:** Metal  
**Medida:** 1 x 13 cm  
**Área de Impresión:** 1 x 6 cm  
**Técnica de Impresión:** Grabado Espejo  
**Colores:** A/O/R/V/Y Metalizados  
**Tinta:** Negra



Mecanismo twist. Incluye estuche transparente.

## INF 080-02

FRISBEE BASKETBALL



Incluye funda.

## INF 080-04

FRISBEE TENNIS



Incluye funda.

## CHM 006

CHAMARRA JACKET  
CLASS





Chamarra en dos colores.

**Material:** Nylon  
**Tallas:** M/L  
**Área de Impresión:** 12 x 7 cm  
**Técnica de Impresión:** Bordado / Serigrafía  
**Colores:** Blanco con Azul Marino

## SIN 167

BOLSA MALETA  
NASSAU



R

**Material:** Non Woven  
**Medida:** 42 x 34 cm  
**Área de Impresión:** 10 x 12 cm  
**Técnica de Impresión:** Serigrafía  
**Colores:** A/N/R



N

A

Textura bolitas solo al frente.

## SIN 020

BOLSA CON CORDÓN  
NITRO



Y

**Material:** Nylon  
**Medida:** 36 x 45 cm  
**Área de Impresión:** 25 x 32 cm  
**Técnica de Impresión:** Serigrafía  
**Colores:** B/Y



B

Incluye cierre frontal.

## SOC 170

BALÓN METALIC





**Material:** EVA / PVC  
**Medida:** No. 5  
**Área de Impresión:** 13 x 3 cm  
**Técnica de Impresión:** Serigrafía  
**Colores:** Rojo Metálico





























































Cámara blader rubber, 30-32 gajos.  
Peso 380 gr. Cosido a máquina.  
2 capas.























## SIN 505

MALETA CAMUFLAJE



**Material:** Nylon  
**Medida:** 45 x 27 cm  
**Área de Impresión:** 38 x 10 cm  
**Técnica de Impresión:** Serigrafía  
**Colores:** Rojo















CÓDIGO	PÁG	CÓDIGO	PÁG	CÓDIGO	PÁG	CÓDIGO	PÁG	CÓDIGO	PÁG	CÓDIGO	PÁG		
	112		243		152		219		71		213		105
	109	<b>A</b> 	215		151		219		73		311		105
	112		217		175		72 218		73		78		106
	112		117		313		11		76		73		106
	107		117		88		11		77		78		105
	244		119		87	<b>C</b> 	128		75		78	<b>D</b> 	218
	243		120		88		128		87		131		169
	246		118		87		128		77		106		163
	246		149	<b>B</b> 	217		128		77		113		165
	109		147		211		314		77		103		171
	245		145		212		315		317		103		167
	244		148		211		314		317		105		166
	241		148		212 256		311		317 324		103		173
	245		151		212		311		318		106		166
			150		211		71		213		131		166















CÓDIGO	PÁG	CÓDIGO	PÁG	CÓDIGO	PÁG	CÓDIGO	PÁG	CÓDIGO	PÁG	CÓDIGO	PÁG				
 DAM 501	172	 DAM 810	171	<b>E</b>	 ECO 001	40	 GM 001	192	 HER 012	236	 HER 09	238	 HL 2010	133	
 DAM 502	172	 DAM 860	169		 ECO 005	40	 GM 003	190	 HER 013	238	 HL 1100	133	 HL 2011	138	
 DAM 505	173	 DAM 870	168		 EST 015	12	 GM 005	192	 HER 014	238	 HL 1200	136	 HL 2012	133	
 DAM 5120	170	 DAM 925	171		 EST 030	11	 GM 010	189	 HER 015	232	 HL 1300	136	 HL 2100	134	
 DAM 5140	170	 DPO 001	57		 EST 040	12	 GM 020	189	 HER 016	240	 HL 1400	138	 HL 2720	137	
 DAM 530	167	 DPO 007	197	<b>F</b>	 FREE 005	189	 GM 030	191	 HER 017	235	 HL 150	129	 HL 2900	135	
 DAM 540	168	 DPO 008	197	<b>G</b>	 GEL 001	39	 GM 040	190	 HER 019	232	 HL 1500	132	 HL 3500	129 319	
 DAM 560	165	 DPO 010-1	197		 GEL 050	39	 GM 050	191	 HER 02	239	 HL 1505	134	 HL 4000	138	
 DAM 570	167	 DPO 011-1	198		 GEP 003	313	 GM 080	189	 HER 020	236	 HL 1550	132	 HL 500	136	
 DAM 600	166	 DPO 012	58		 GLF 01	100 256	 GMR 001	315	 HER 03	237	 HL 1600	132	 HL 5000	137	
 DAM 699	169	 DPO 014	198		 GLF 04	256	 GSP 001	321	 HER 04	240	 HL 1650	132	 HL 5600	135	
 DAM 701	163	 DPO 015	57		 GLF 05	255	 GSP 002	313	 HER 05	240	 HL 1700	135	 HL 6000	137	
 DAM 702	163	 DPO 016	319		 GLF 06	255	<b>H</b>	 HAT 001	315	 HER 06	234	 HL 1800	134	 HL 6520	113
 DAM 773	168	 DPO 020	58		 GLF 07	255	 HER 01	235	 HER 07	239	 HL 2000	137	 HL 6655	113	
 DAM 804	165	 DPO 025	198		 GLF 08	255	 HER 010	237	 HER 08	237	 HL 2009	129			















CÓDIGO	PÁG	CÓDIGO	PÁG	CÓDIGO	PÁG	CÓDIGO	PÁG	CÓDIGO	PÁG	CÓDIGO	PÁG		
HL 7400	131	INF 035	194	JM 004	250	K 180	53	KTC 004	209	LAM 100	228	LAM 800	229
HL 8000	131	INF 040	194	JM 005	251	K 231	55	KTC 005	209	LAM 1450	229	LAM 950	232
HL 8400	138	INF 060	191	JM 008	247	K 250	55	KTC 006	205	LAM 200	231	LAP 001	72
HL 900	135	INF 080	187	JM 009	250	K 256	43	KTC 007	210 260	LAM 2365	227	LAP 002	70
HUB 01	69	INF 080-02	323	JM 010	251	K 300	55	KTC 008	210 260	LAM 300	225	LAP 003	71
HUB 02	69	INF 080-04	323	JM 014	250	K 511	18	KTC 009	209	LAM 350	230	LAP 004	70
HUB 04	69	INF 100	194	JM 015	251	K 513	57	KTC 010	193	LAM 400	319	LAP 005	290
HUB 05	69	INF 120	196	JM 018	252 256	K 63290	51	KTC 011	113	LAM 450	230	LEN 001	220
HUB 06	70	INF 210	195	JM 020	249	K 6470	51	KTC 012	220	LAM 500	225	LIG 001	241
HUB 07	72	INF 300	193	JM 021	247	K 6550	46	KTC 013	244	LAM 550	229	<b>M</b> M 1010	55
<b>I</b> INF 010	191	INF 550	192	JM 025	247	KA 82593-11	107	KTC 014	208	LAM 5557	225	M 1030	53
INF 012	195	INF 600	195	JM 030	252	KIT 911	177	KTC 015	210 260	LAM 584	227	M 1040	52
INF 015	187	INF 610	196	JM 035	252	KIT INF 100	195	KTC 100	208	LAM 600	231	M 1050	53
INF 030	193	<b>J</b> JM 001	249	<b>K</b> K 100	54	KIT RQ 200	9	<b>L</b> LAM 001	56	LAM 621	227	M 1060	52
		JM 002	249	K 150	54	KTC 003	209	LAM 050	58	LAM 700	228	M 1070	52

































CÓDIGO	PÁG	CÓDIGO	PÁG	CÓDIGO	PÁG	CÓDIGO	PÁG	CÓDIGO	PÁG	CÓDIGO	PÁG		
 M 1080	44	 M 3500	51	 M 80200	126	 M 82100	125	 MK 2000	99	 MOP 012	66	 PAR 04	223
 M 1090	44	 M 4550	46	 M 80307	97	 M 82724	121	 MK 250	102	 MOP 013	64	 PAR 05	224
 M 2000	44	 M 5010	47	 M 80400	125	 M 83200	111	 MK 3000	101	 MOP 014	64	 PAR 06	221
 M 2010	56	 M 5530	41	 M 80407	97	 M 83300	123	 MK 400	99	 MOP 015	64	 PL 123	13
 M 2015	56	 M 5715	43	 M 80444	121	 M 83400	110	 MK 5272	321	 MOU 001	68	 PL 1500	319
 M 2020	48	 M 5813	45	 M 80500	125	 M 83450	110	 MK 600	99	 MOU 010	67	 PL 350	13
 M 2025	48	 M 6010	46	 M 80555	123	 M 83945-11	110	 MK 700	101	 MOU 040	68	 PLY 001	310
 M 2030	47	 M 6232	43	 M 80600	124	 M 83964	111	 MNT 001	176	 MOU 050	67	 PLY 002	309
 M 2035	47	 M 63280	41	 M 80700	126	 M 86114-5	111	 MOP 001	63	 MOU 060	67	 PLY 003	309
 M 2040	50	 M 63282	41	 M 80719	123	 MK 001	321	 MOP 002	63	 MOU 070	68	 PLY 004	310
 M 2045	54	 M 63600	49	 M 80780	216	 MK 010	97	 MOP 004	63	 MP3 010	86	 PLY 005	307
 M 3100	50	 M 64104-12	49	 M 80800	127	 MK 070	321	 MOP 006	65	 MP3 020	86	 PLY 006	307
 M 3150	50	 M 6850	49	 M 80900	127	 MK 080	102	 MOP 007	65	 PAR 01	223	 PRE 003	197
 M 3401	45	 M 7350	48	 M 81200	124	 MK 090	100	 MOP 008	66	 PAR 02	221	 PRO 002	60
 M 3402	45	 M 80100	121	 M 81300	126	 MK 100	101	 MOP 010	65	 PAR 03	224		

CÓDIGO	PÁG
 PRO 005	60
 PRO 008	59
 PRO 011	73
 PRO 012	115
 PRO 015	60
 PRO 016	59
 PRO 024	235
 PRO 027	115
 PRO 030	115
 PRO 032	165
 PRO 034	59
 PRO 052	115
 PRO 055	114
 PRO 070	321















CÓDIGO	PÁG
 PRO 111	215
 PRO 115	215
 PRO 200	321
 PRO 220	319
 PRO 300	114
 PRO 519	111
 PRO 540	218
 PRO 600	182
 PRT 001	201
 PRT 040	199
 PRT 060	203
 PRT 080	201
 PRT 090	201
 PRT 100	202
 PRT 105	203









































































































CÓDIGO	PÁG
 PRT 200	202
 PRT 350	203
 PRT 400	199
 PRT 500	199
 PRT 600	202
 PT 0942	178
 PT 100	180
 PT 200	178
 PT 2100	181
 PT 2164	181
 PT 2165	179
 PT 2166	180
 PT 2167	179
 PT 2362	180
 PT 300	178

CÓDIGO	PÁG
 PT 3012	179
 PT 588	179
 PW 0025	206
 PWT 030	206
 PWT 050	205
 PWT 060	207
 PWT 080	207
 RCO 001	114
 RQ 008	5
 RQ 015	5
 RQ 1002	7
 RQ 1003	7
 SET 001	61
 SET 002	61
 SET 003	61









































CÓDIGO	PÁG
 SG 204	322
 SH 1005	27
 SH 1010	3
 SH 1015	14
 SH 1020	26
 SH 1025	32
 SH 1030	21
 SH 1035	32
 SH 1040	16
 SH 1045	38
 SH 1050	323
 SH 1055	34
 SH 1060	26
 SH 1065	22
 SH 1070	38

CÓDIGO	PÁG
 SH 1075	38
 SH 1080	36
 SH 1085	28
 SH 1090	19
 SH 1095	26
 SH 1100	13
 SH 1110	14
 SH 1120	14
 SH 1123	19
 SH 1135	21
 SH 1140	34
 SH 1145	17 175
 SH 1160	29
 SH 1170	322
 SH 1180	39

CÓDIGO	PÁG
 SH 1190	31
 SH 1200	17
 SH 1205	33
 SH 1210	8
 SH 1215	16
 SH 1225	10
 SH 1240	31
 SH 1245	6
 SH 1255	10
 SH 1260	8
 SH 1265	59
 SH 1275	8
 SH 1280	6
 SH 1290	12
 SH 1295	5

CÓDIGO	PÁG	CÓDIGO	PÁG	CÓDIGO	PÁG	CÓDIGO	PÁG	CÓDIGO	PÁG	CÓDIGO	PÁG		
 SH 1300	24	 SH 1405	19	 SH 1580	323	 SH 3100	29	 SIN 011	217	 SIN 039	287	 SIN 062	272
 SH 1310	25	 SH 1415	21	 SH 1590	28	 SH 3250	15	 SIN 012	217	 SIN 040	287	 SIN 065	270
 SH 1315	30	 SH 1440	31	 SH 1600	17	 SH 3500	6	 SIN 014	127	 SIN 041	263	 SIN 070	284
 SH 1320	322	 SH 1450	25	 SH 1605	27	 SH 3620	37	 SIN 019	268	 SIN 043	263	 SIN 077	272
 SH 1325	30	 SH 1460	20	 SH 1620	23	 SH 5500	9	 SIN 020	324	 SIN 045	294	 SIN 080	259
 SH 1330	30	 SH 1465	20	 SH 1630	23	 SH 6500	7	 SIN 021	267	 SIN 047	264	 SIN 081	265
 SH 1340	28	 SH 1470	3	 SH 1690	37	 SH 7850	25	 SIN 022	263	 SIN 051	280	 SIN 084	279
 SH 1345	32	 SH 1490	323	 SH 1720	11	 SH 8000	15	 SIN 025	277	 SIN 052	300	 SIN 087	271
 SH 1350	18	 SH 1500	18	 SH 1800	322	 SH 8010	15	 SIN 026	275	 SIN 053	304	 SIN 088	268
 SH 1355	9	 SH 1507	35	 SH 2097	23	 SH 9010	36	 SIN 028	301	 SIN 054	269	 SIN 095	287
 SH 1370	3	 SH 1519	33	 SH 2100	34	 SIN 001	291	 SIN 029	257	 SIN 055	270	 SIN 110	289
 SH 1375	33	 SH 1530	37	 SH 2500	322	 SIN 003	259	 SIN 032	297	 SIN 056	302	 SIN 112	266
 SH 1380	22	 SH 1540	35	 SH 2550	29	 SIN 005	289	 SIN 035	305	 SIN 057	259	 SIN 113	266
 SH 1385	24	 SH 1550	35	 SH 2700	16	 SIN 007	257	 SIN 037	273	 SIN 058	292	 SIN 114	266
 SH 1390	24	 SH 1570	27	 SH 3000	198	 SIN 010	277	 SIN 038	275	 SIN 060	275		

CÓDIGO	PÁG	CÓDIGO	PÁG	CÓDIGO	PÁG	CÓDIGO	PÁG	CÓDIGO	PÁG	CÓDIGO	PÁG	CÓDIGO	PÁG
	277		286		271		273		215		181		253
SIN 120		SIN 145		SIN 185		SIN 402		SIN 900		SOC 011-07		SOC 500	
	273		276		293		282		271		181		234
SIN 121		SIN 148		SIN 190		SIN 410		SIN 901		SOC 011-09		ST 010	
	80		276		293		216		284		182		233
SIN 125		SIN 149		SIN 191		SIN 420		SIN 902		SOC 013		ST 040	
	269		302		265		259		278		185		233
SIN 130		SIN 150		SIN 210		SIN 450		SIN 903		SOC 013 W		ST 060	
	261		295		265		300		176		187		233
SIN 131		SIN 151		SIN 220		SIN 460		SLD 002		SOC 022		ST 070	
	295		306		264		283		176		183		234
SIN 132		SIN 154		SIN 230		SIN 470		SLD 003		SOC 023		ST 081	
	298		279		267		282		177		183		79
SIN 133		SIN 159		SIN 235		SIN 480		SLD 006		SOC 024		TAB 001	
	289		281		297		276		177		183		79
SIN 135		SIN 160		SIN 280		SIN 490		SLD 007		SOC 026		TAB 002	
	290		324		301		297		175		183		79
SIN 136		SIN 167		SIN 300		SIN 503		SLD 008		SOC 027		TAB 003	
	298		283		299		324		186		184		80
SIN 139		SIN 170		SIN 305		SIN 505		SOC 011-01		SOC 028		TAB 004	
	305		281		303		305		186		184		139
SIN 140		SIN 172		SIN 306		SIN 710		SOC 011-02		SOC 029		TAZ 001	
	261		286		306		291		185		253		143
SIN 141		SIN 173		SIN 307		SIN 720		SOC 011-03		SOC 032		TAZ 002	
	285		264		294		216		185		324		139
SIN 142		SIN 175		SIN 308		SIN 721		SOC 011-04		SOC 170		TAZ 003	
	285		292		299		220		186		145		139
SIN 143		SIN 180		SIN 333		SIN 800		SOC 011-05		SOC 180		TAZ 004	
	303		280		278 318		185		253		143	TAZ 005	
SIN 184		SIN 375		SIN 802		SOC 011-06							

CÓDIGO	PÁG	CÓDIGO	PÁG	CÓDIGO	PÁG	CÓDIGO	PÁG	CÓDIGO	PÁG	CÓDIGO	PÁG
 TAZ 007	144	 TMPS 13	158	 TMPS 31	159	 USB 002	89	 USB 020	92	 Z 400	85
 TAZ 009	144	 TMPS 15	162	 TMPS 400	155	 USB 003	319	 USB 021	92	 Z 420	83
 TAZ 010	143	 TMPS 16	161	 TMPS 45	156	 USB 004	89	 USB 023	94	 Z 650	85
 TAZ 011	142	 TMPS 17	153	 TMPS 60	156	 USB 006	93	 USB 024	94		
 TAZ 012	142	 TMPS 18	153	 TMPS 65	160	 USB 007	91	 USB 05	10		
 TAZ 013	144	 TMPS 19	161	 TMPS 80	156	 USB 008	93	 USB 100	91		
 TAZ 014	142	 TMPS 200	141	 TMPS 85	160	 USB 009	92	 USB 110	93		
 TCH 001	76	 TMPS 201	141	 TMPS 90	161	 USB 011	95	 USB 120	95		
 TCH 002	76	 TMPS 23	159	 TOA 001	219	 USB 012	89	<b>Z</b>  Z 010	81		
 TCH 003	75	 TMPS 24	157	 TOA 002	219	 USB 013	95	 Z 100	81		
 TCH 004	75	 TMPS 26	141	 TT 02	157	 USB 014	91	 Z 110	84		
 TMF 06	162	 TMPS 27	158	 TT 050	145	 USB 015	96	 Z 200	84		
 TMF 07	153	 TMPS 29	162	 TT 09	157	 USB 016	94	 Z 230	83		
 TMPS 101	155	 TMPS 30	161	<b>U</b>  U 1071	171	 USB 017	96	 Z 270	81		
 TMPS 11	158	 TMPS 300	155	 U 1226	239	 USB 018	96	 Z 290	84		

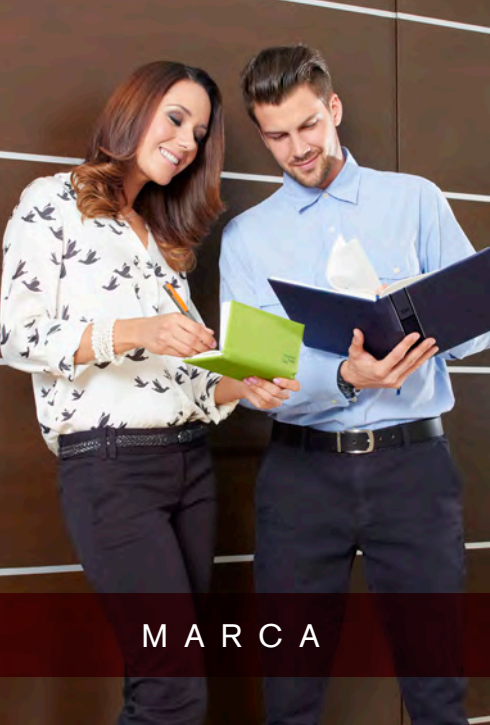

MARCA



SERVICIO



SUENOS



ESTILO



IMAGEN



EXPERIENCIA



FUTURO



CONFIANZA

15 ANIVERSARIO  
EVOLUCIÓN EN PROMOCIONALES  
SERVICIO  
CONFIABLE  
EVOLUCIÓN  
IDEAL



LA INFORMACIÓN Y EL COLOR DE LOS ARTÍCULOS REALES PUEDEN VARIAR A LOS ARTÍCULOS DESCRITOS EN ÉSTE CATÁLOGO. LAS ÁREAS Y TÉCNICAS DE IMPRESIÓN Y GRABADO SON RECOMENDACIONES Y SON RESPONSABILIDAD DE QUIEN LOS UTILIZA Y DE LOS EQUIPOS DE TRANSFORMACIÓN CON QUE CUENTEN. LOS LOGOTIPOS Y MARCAS QUE SE PUBLICAN EN ESTE CATÁLOGO SON DE CARÁCTER ILUSTRATIVO, SON PROPIEDAD DE QUIEN LAS PROTEGE, POR LO QUE NO ESTÁN A LA VENTA. LAS FOTOGRAFÍAS CUENTAN CON DERECHOS Y PARA SU REPRODUCCIÓN TOTAL O PARCIAL REQUIEREN PERMISO POR ESCRITO DEL AUTOR.

evolución en promocionales<sup>®</sup>

ZEGNO<sup>®</sup>



to<sup>ssh</sup>

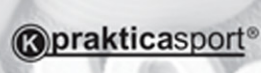

ZEGNO<sup>®</sup>

ESCRITURA